



HENRY PARK PRIMARY SCHOOL  
2024 TERM REVIEW 2  
MATHEMATICS  
PRIMARY 6

Booklet A : \_\_\_\_\_ / 20

Booklet B : \_\_\_\_\_ / 25

Paper 2 : \_\_\_\_\_ / 55

Total : \_\_\_\_\_ / 100

Name: \_\_\_\_\_ ( )

Class: Primary 6 \_\_\_\_\_

Date: \_\_\_\_\_ Parent's signature: \_\_\_\_\_

**Booklet A**

Questions 1 to 10 carry 1 mark each. Questions 11 to 15 carry 2 marks each.

For each question, four options are given. One of them is the correct answer.

Make your choice (1, 2, 3 or 4) and shade your answer in the Optical Answer Sheet.

(20 marks)

1. Round 50.282 to the nearest tenth.

(1) 50

(2) 50.2

(3) 50.3

(4) 50.28

2. Which of the following is likely to be the length of a bed for an adult?

(1) 2 m

(2) 2 cm

(3) 20 m

(4) 20 cm

Go on to the next page

3. In the scale below, what is the value of X?

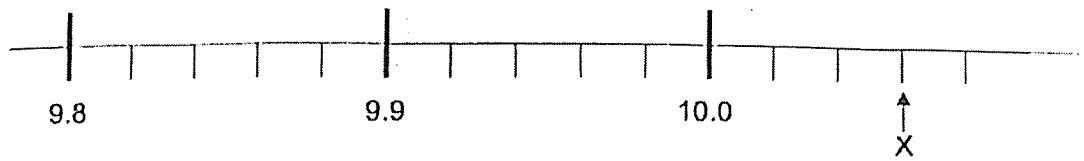

- (1) 10.3  
(2) 10.6  
(3) 10.03  
(4) 10.06
4. 3 children shared a pack of stickers. The ratio of Elly's stickers to Flynn's stickers to Gerry's stickers is 4 : 2 : 5. Gerry received 180 stickers. How many stickers did Elly and Flynn receive?
- (1) 216  
(2) 252  
(3) 315  
(4) 324
5. A furniture store sold 50 sofas in January. In February, it sold 40 sofas. What is the percentage decrease in the number of sofas sold in February?
- (1) 10%  
(2) 20%  
(3) 25%  
(4) 80%

Go on to the next page

6. The semicircle below has a radius of 10 cm.  
What is the perimeter of the shaded figure? Take  $\pi = 3.14$ .

- (1) 15.7 cm
- (2) 25.7 cm
- (3) 31.4 cm
- (4) 51.4 cm

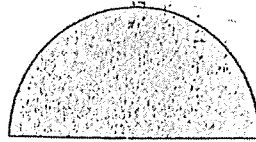

7. A solid cuboid of height 10 cm has a square base of side 4 cm.  
What is its volume?

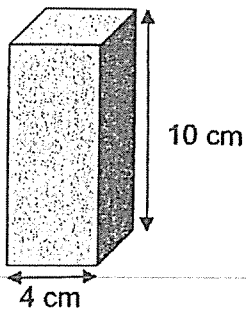

- (1) 40 cm<sup>3</sup>
- (2) 80 cm<sup>3</sup>
- (3) 160 cm<sup>3</sup>
- (4) 400 cm<sup>3</sup>

Go on to the next page

8. The figure below shows trapezium PQRS. Which of the following is a property of a trapezium?

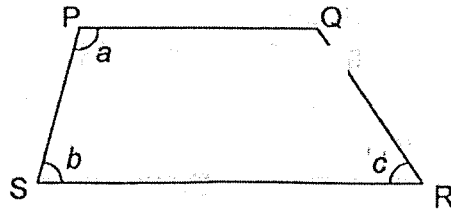

- (1)  $\angle a = \angle c$
  - (2)  $\angle b + \angle c = 180^\circ$
  - (3) It has one pair of equal sides.
  - (4) It has one pair of parallel sides.
9. In the figure below, which two lines are parallel?

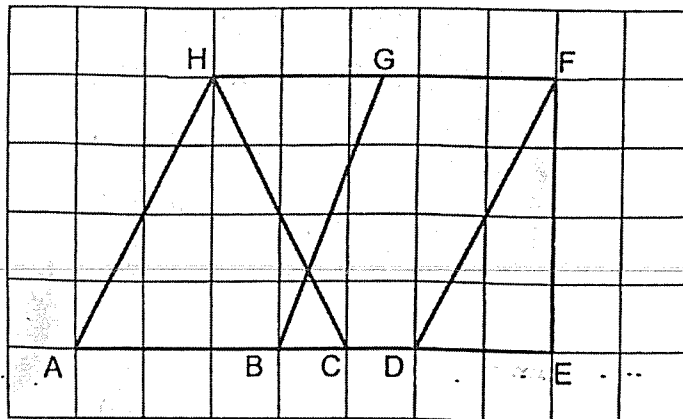

- (1) AE and EF
- (2) AH and BG
- (3) BG and DF
- (4) DF and AH

Go on to the next page

Use the information below to answer questions 10 and 11.

The bar graph shows the number of burgers and pies sold in a shop over four days.

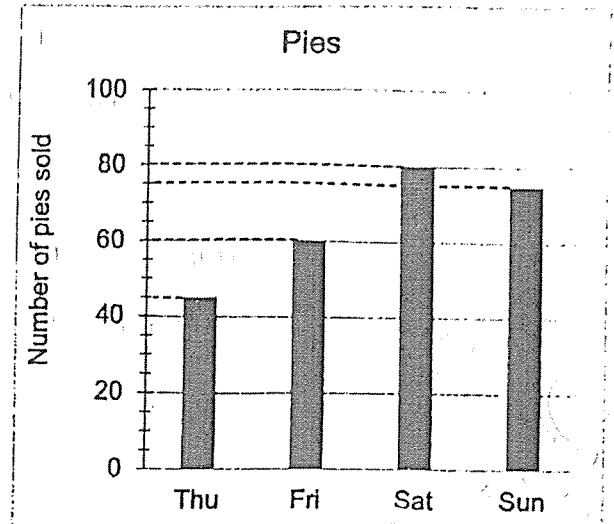
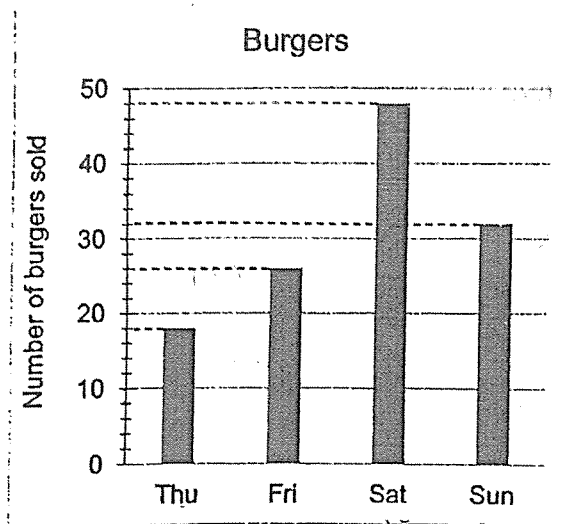

10. Find the total number of burgers sold on Thursday and Sunday.

- (1) 50
- (2) 58
- (3) 66
- (4) 120

11. The number of pies sold on Monday was an 80% increase from the number sold on Thursday. How many pies were sold on Monday?

- (1) 33
- (2) 36
- (3) 81
- (4) 90

Go on to the next page

12. A wire of length 7.2 m was cut into 3 pieces. The first piece was 3 times as long as the second piece. The second piece was twice as long as the third piece. How long was the second piece of wire?

- (1) 0.8 m
- (2) 1.6 m
- (3) 2.4 m
- (4) 4.8 m

13. Figure 1 is a right-angled triangle with a base to height ratio of 2 : 3. Figure 2 is made up of four such right-angled triangles. The length of AB is 60 cm.



Figure 1

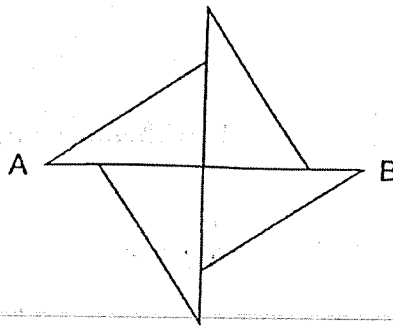

Figure 2

What is the area of figure 1?

- (1) 300 cm<sup>2</sup>
- (2) 432 cm<sup>2</sup>
- (3) 600 cm<sup>2</sup>
- (4) 675 cm<sup>2</sup>

Go on to the next page

14. After a discount of 25%, an adult would have to pay \$60 for a buffet lunch. A senior citizen gets an additional discount of \$12. Find the percentage discount given to the senior citizen for the buffet lunch.
- (1) 15%
  - (2) 20%
  - (3) 25%
  - (4) 40%
15. Oman and Pauline made figurines over 2 days. On Monday, Oman made 19 figurines more than Pauline. On Tuesday, Oman made another 20 figurines and Pauline made another 15. At the end of the two days, Oman made  $\frac{3}{5}$  of the total number of figurines. What was the total number of figurines Pauline made on Monday and Tuesday?
- (1) 24
  - (2) 48
  - (3) 54
  - (4) 72

Go on to Booklet B



HENRY PARK PRIMARY SCHOOL  
2024 TERM REVIEW 2  
MATHEMATICS  
PRIMARY 6

Name: \_\_\_\_\_ ( )

Booklet B : \_\_\_\_\_ / 25

Date: \_\_\_\_\_ Parent's signature: \_\_\_\_\_

**Booklet B**

Questions 16 to 20 carry 1 mark each. Write your answers in the spaces provided. For questions which require units, give your answers in the units stated.

(5 marks)

16. Express  $9\frac{7}{25}$  as a decimal.

Ans: \_\_\_\_\_

17. Express 4.3% as a fraction.

Ans: \_\_\_\_\_

18. The opening hours of a clinic are shown below. How long is the clinic open each day?  
Give your answer in hours and minutes.

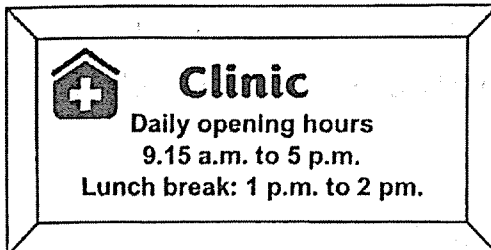

Ans: \_\_\_\_\_ h \_\_\_\_\_ min



19. In the figure below, AB and PQ are straight lines. Find  $\angle y$

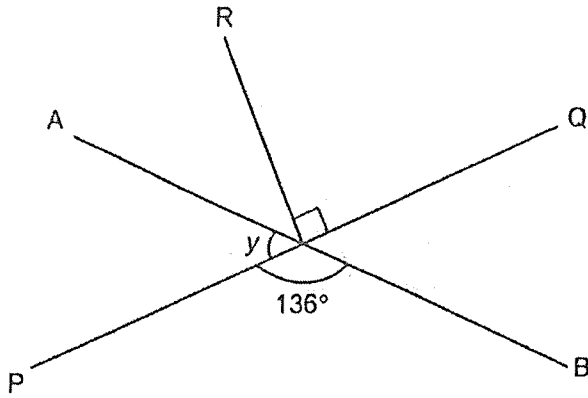

Ans: \_\_\_\_\_

20. The line graph shows the number of fish in a pond from January to June.

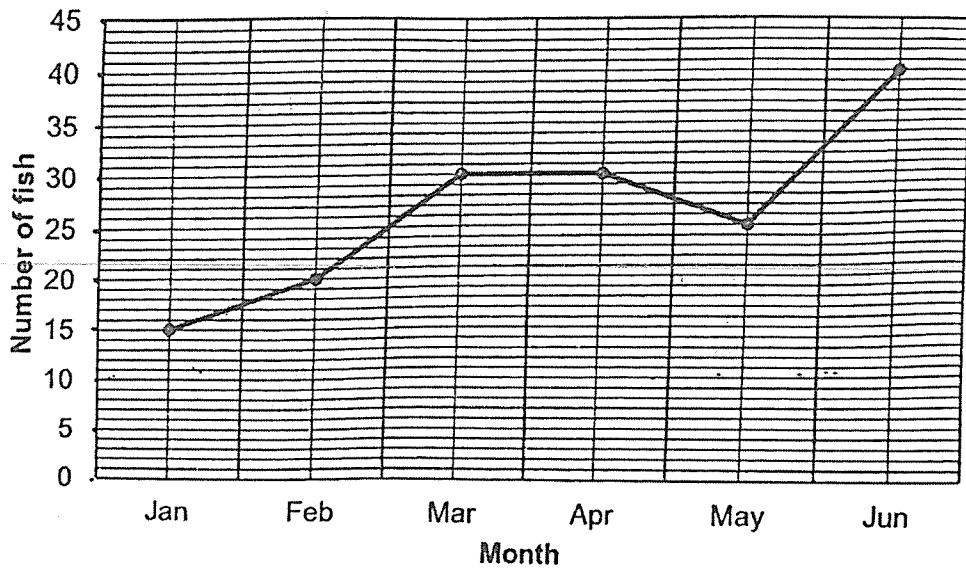

Between which 1-month period was the increase in number of fishes in the pond the greatest?

Ans: \_\_\_\_\_ and \_\_\_\_\_

Questions 21 to 30 carry 2 marks each. Show your working clearly and write your answers in the spaces provided. For questions which require units, give your answers in the units stated.

(20 marks)

21. Use all the digits 3, 5, 6, 7 to form

(a) the smallest 4-digit multiple of 5

Ans: (a) \_\_\_\_\_

(b) the number closest to 7000

Ans: (b) \_\_\_\_\_

22. (a) The diagram below shows half of a symmetrical figure with  $XY$  as the line of symmetry. Draw and complete the symmetric figure.

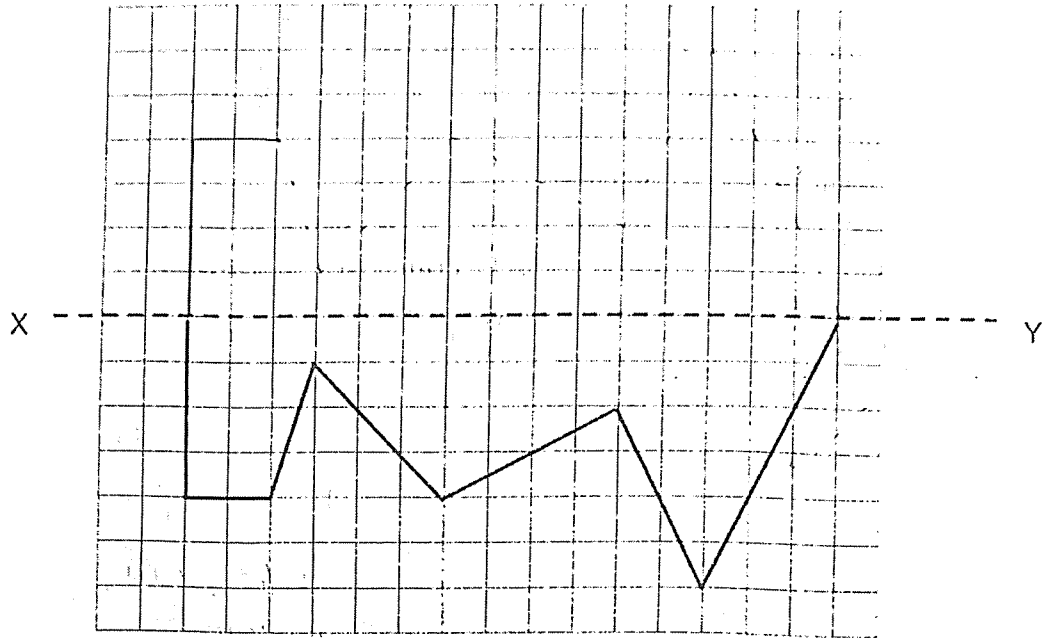

- (b) Draw a line perpendicular to  $EF$ , passing through point  $G$ .

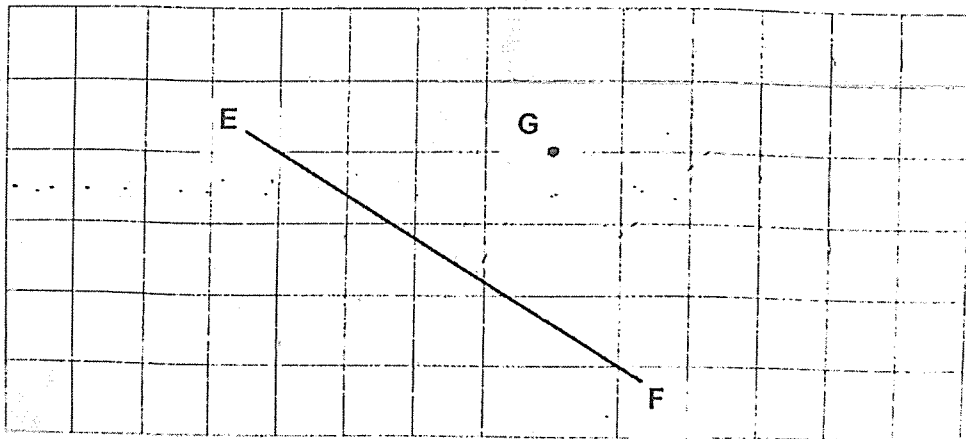

23. Chelsea used 12 identical cubes of side 1 cm to form the solid below. She then added some cubes to form a cuboid 4 cm by 6 cm by 6 cm. How many cubes did she add?

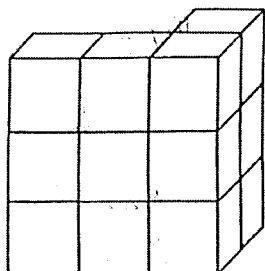

Ans: \_\_\_\_\_

24. The figure below is a rectangle with a length of 9 cm and breadth of 6 cm. Find the total shaded area.

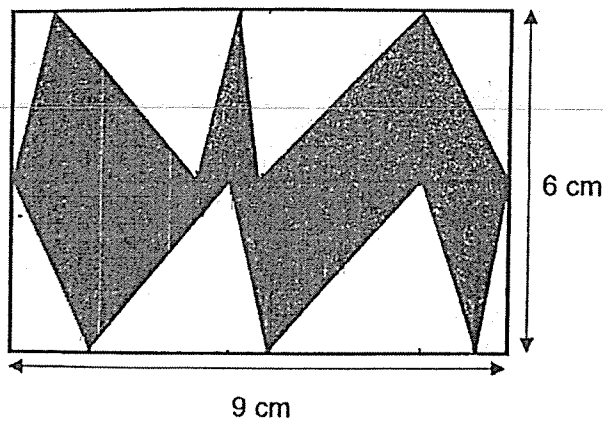

Ans: \_\_\_\_\_  $\text{cm}^2$

25. Shival paid \$945 for a golf club and 4 boxes of golf balls. The price of a box of golf balls was  $\frac{2}{7}$  of the price of the golf club. How much did Shival pay for the golf club?

Ans: \$ \_\_\_\_\_

---

26. A choir has 50 male and 70 female members. 16% of the male members and 10% of the female members are university students and the remaining members are not university students. What percentage of the members are **not** university students?
- 

Ans: \_\_\_\_\_ %

---

27. A square and a rectangle overlap to form the figure below. The ratio of the area of the shaded part to the area of the square to the area of the rectangle is  $1 : 2 : 7$ . The area of the rectangle is  $84 \text{ cm}^2$ . Find the area of the whole figure.

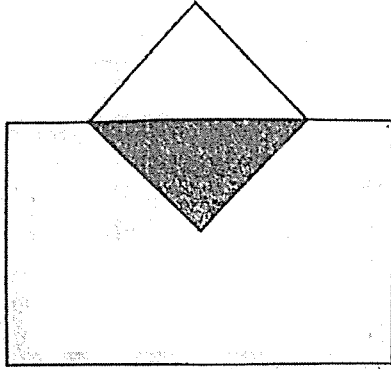

Ans: \_\_\_\_\_  $\text{cm}^2$

28. Mr Huang has balloons of 3 different colours.  $\frac{1}{4}$  of the balloons are purple. The ratio of the number of yellow balloons to the number of orange balloons is  $2 : 3$ . What is the ratio of the number of purple balloons to the number of orange balloons?

Ans: \_\_\_\_\_

29. A trapezium ABCD is drawn on the square grid. Using the line DE, draw triangle DEF such that it has the same area as trapezium ABCD.

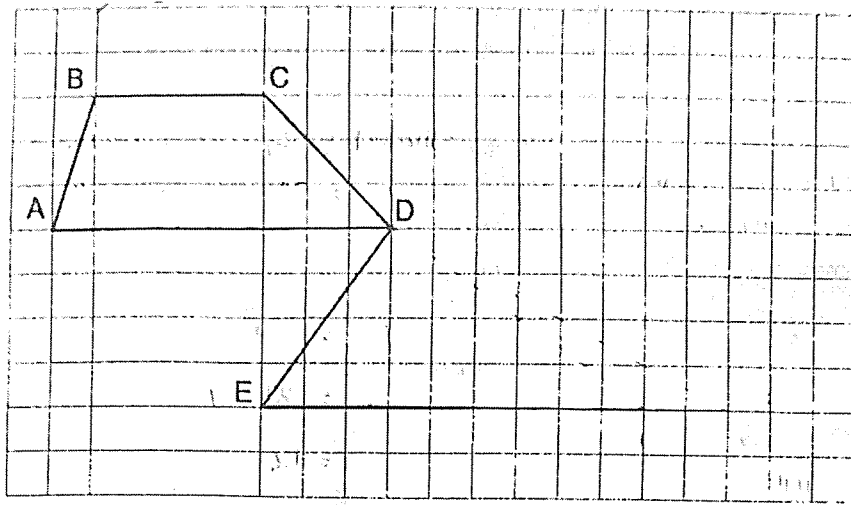

30. The figure below shows a cylinder with a diameter of 35 cm placed a distance away from a wall. The distance between the centre of the cylinder to the wall is 12.1 m. How many complete turns will the cylinder have to make before it touches the wall?

Take  $\pi = \frac{22}{7}$ .

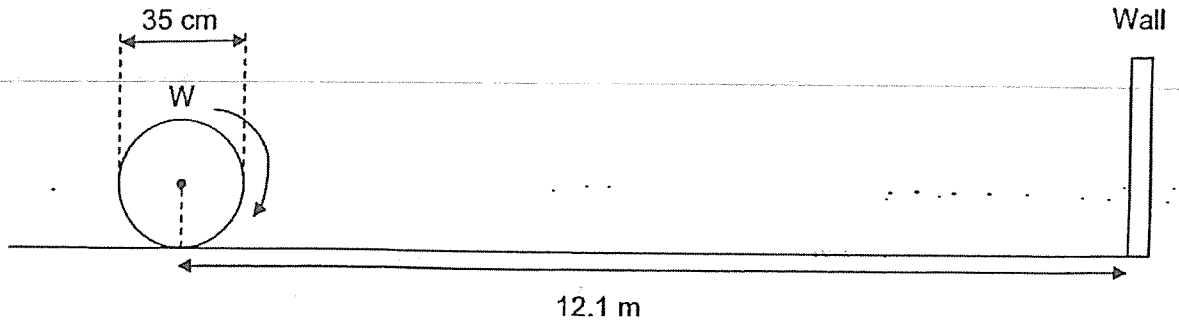

Ans: \_\_\_\_\_



HENRY PARK PRIMARY SCHOOL  
2024 TERM REVIEW 2  
MATHEMATICS  
PRIMARY 6

Paper 2 : \_\_\_\_\_ / 55

Name: \_\_\_\_\_ ( )

Class: Primary 6 \_\_\_\_\_

Date: \_\_\_\_\_

Paper 2

Questions 1 to 5 carry 2 marks each. Show your working clearly and write your answers in the spaces provided. For questions which require units, give your answers in the units stated.

(10 marks)

1. Mrs Chan bought 150 pencils and 100 erasers for her students. She divided the pencils equally among them and had 17 pencils left. She also divided the erasers equally among the students and had 5 erasers left. How many students were there?

Ans: \_\_\_\_\_

2. Five boys shared the cost of a present equally. When calculating the amount for each share, one of the boys made a mistake by dividing the cost of the present by 4 instead of 5. Each boy paid \$3.75 more than his original share. What is the cost of the present?

Ans: \$ \_\_\_\_\_



3. The figure below is made up of three identical squares. Given that  $EH = 72$  cm,  $CY = 16$  cm and  $BX = YF$ . Find the area of the shaded part.

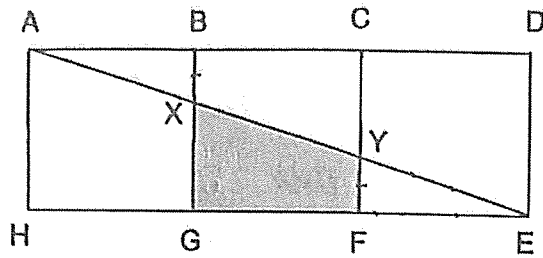

Ans: \_\_\_\_\_ cm<sup>2</sup>

4. The average cost of 3 different backpacks is \$12.70. The total cost of 2 of the backpacks is \$16.80. What is the cost of the third backpack?

Ans: \$ \_\_\_\_\_

Please do not write in the margin.

5. Malik had 140 postcards and Neil had 112 postcards. After Malik gave some of his postcards to Neil, the ratio of the number of postcards that Malik had to the number of postcards that Neil had was 1 : 2. How many postcards did Neil had in the end?

Ans: \_\_\_\_\_

---

**Please do not write in the margin.**

For questions 6 to 17, show your working clearly and write your answers in the spaces provided. The number of marks available is shown in the brackets [ ] at the end of each question or part-question.

(45 marks)

6. ABC bookshop sells only 1 type of calculator. The bar graph below shows the number of calculators the bookshop sold from January to June. The bar for June has not been drawn.

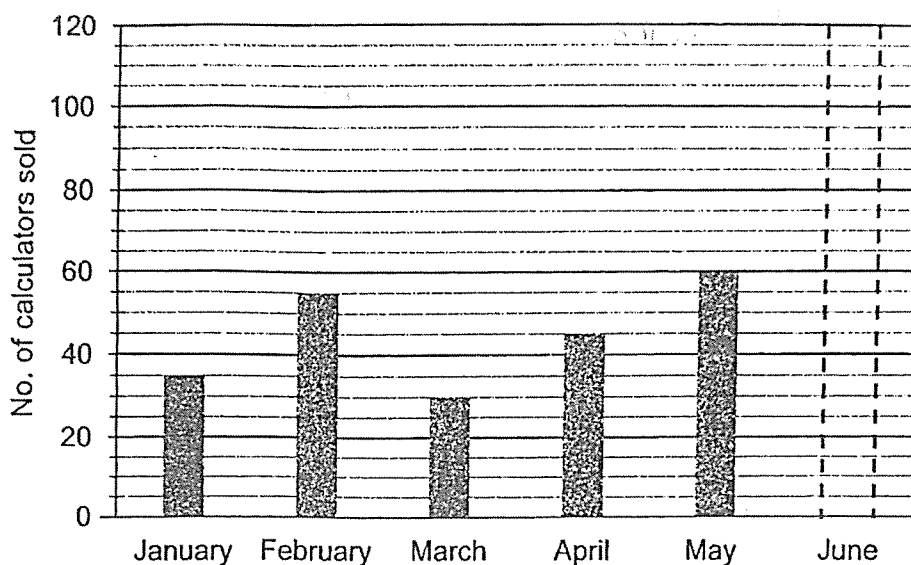

- (a) Given that the average number of calculators sold from January to June was 55, find the number of calculators sold in June.

Ans: (a) \_\_\_\_\_ [2]

- (b) The total amount that the shop collected from all the calculators sold in March was \$1046.40 including 9% GST. Find the cost of 1 calculator excluding GST.

Ans: (b) \_\_\_\_\_ [2]

Please do not write in the margin.

7. In the figure,  $ABPJ$  is a parallelogram and  $LDEG$  is a trapezium.  $AMPF$  is a straight line.  $LD$  is parallel to  $JP$ .  $\angle ABP = 65^\circ$ ,  $\angle MPH = 48^\circ$  and  $\angle LHJ = 54^\circ$ .

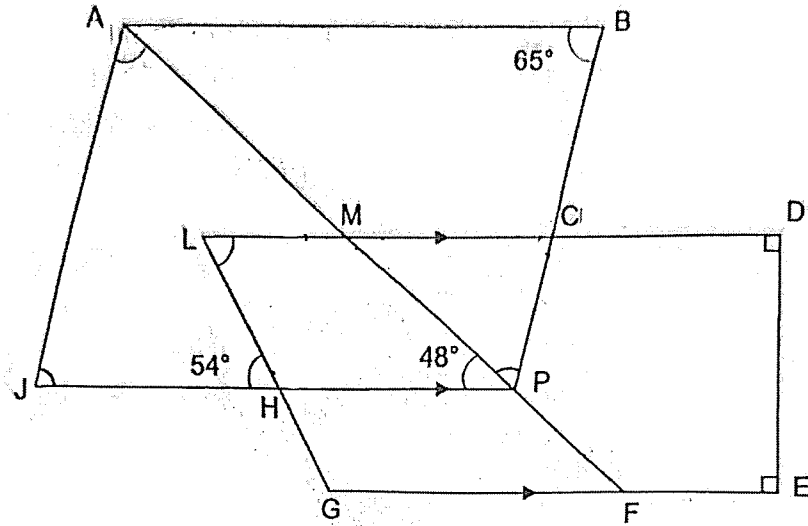

- (a) Find  $\angle JAP$ .

Ans: (a) \_\_\_\_\_ [1]

- (b) Find  $\angle GLD$ .

Ans: (b) \_\_\_\_\_ [2]

Please do not write in the margin.

8. Candice takes 30 days to knit 5 identical scarves while Shelley takes 20 days to knit 4 identical sweaters. Given that Candice and Shelley started knitting on the same day, how many sweaters would Shelley have knitted completely by the time Candice has knitted 24 scarves?

---

Ans: \_\_\_\_\_ [3]

---

9. Pauline, Queenie and Roger had 162 marbles altogether. Pauline gave  $\frac{3}{10}$  of her marbles to Queenie and  $\frac{1}{4}$  of her marbles to Roger. After that, all 3 children had the same number of marbles.

a) What is the ratio of the number of marbles Pauline had to the number of marbles Queenie had to the number of marbles Roger had at first?

Ans: (a) \_\_\_\_\_ [1]

b) How many more marbles did Pauline have than Queenie at first?

Ans: (b) \_\_\_\_\_ [2]

10. Andrea baked some cookies. She gave  $\frac{1}{5}$  of them to her relatives and 56 of them to her friends. She was left with  $\frac{2}{3}$  of the cookies. She packed these cookies into 34 bags. Some bags contained 4 cookies while the rest contained 12 cookies.

(a) How many cookies were packed into the 34 bags?

Ans: (a) \_\_\_\_\_ [2]

(b) How many bags contained 4 cookies each?

Ans: (b) \_\_\_\_\_ [2]

---

Please do not write in the margin.

11. At a musical, a total of 1932 photocards were given out. Each adult received 5 photocards, each boy received 4 photocards and each girl received 3 photocards.  $\frac{1}{4}$  of the people who attended the musical were adults,  $\frac{4}{9}$  of the remainder were boys and the rest were girls. How many adults were there at the musical?

Ans: \_\_\_\_\_ [4]



12. A shop had 60 t-shirts and some blouses at first. After 10 t-shirts and 20% of the blouses were sold, the shop had a total of 118 t-shirts and blouses left. How many blouses did the shop have at first?

---

Ans: \_\_\_\_\_ [3]

---

13. The figure is made up of a big semicircle, two small semicircles and a square.

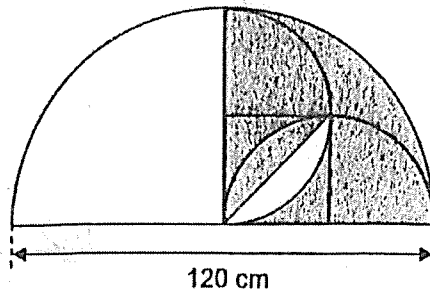

- (a) Find the radius of the small semicircle.

Ans: (a) \_\_\_\_\_ [1]

- (b) Find the area of the unshaded parts of the figure. (Take  $\pi = 3.14$ ).

Ans: (b) \_\_\_\_\_ [3]

14. Jason has several identical square-based wooden blocks. He glued 5 such blocks to form a cuboid as shown in Figure 1. He stacked 4 such cuboids to form a larger cuboid shown in Figure 2.

Given that the length of the cuboid is 80 cm, find the volume of the cuboid shown in Figure 2.

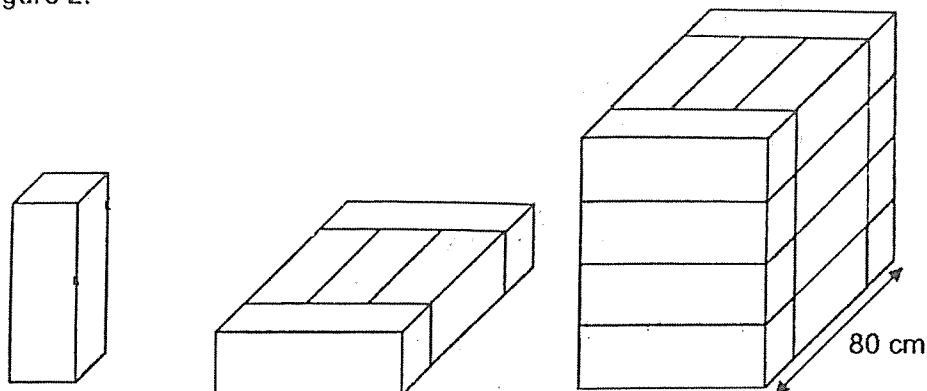

Figure 1

Figure 2

Ans: \_\_\_\_\_ [4]

Please do not write in the margin.

15. In the figure,  $ABXD$  and  $WXYZ$  are overlapping rectangles and  $XMNO$  is a square.  $\angle YXO = \angle OXW$ .  $\angle MXD = 20^\circ$ .

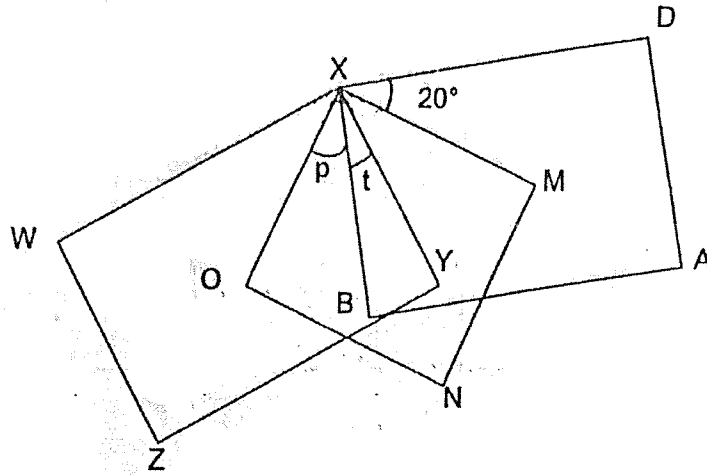

(a) Find  $\angle t$ .

Ans: (a) \_\_\_\_\_ [2]

(b) Find  $\angle p$ .

Ans: (b) \_\_\_\_\_ [1]

Please do not write in the margin

16. Bessie stacked 8 identical cups as shown in Figure A below.

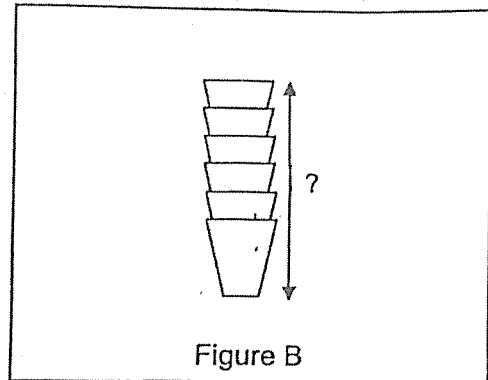
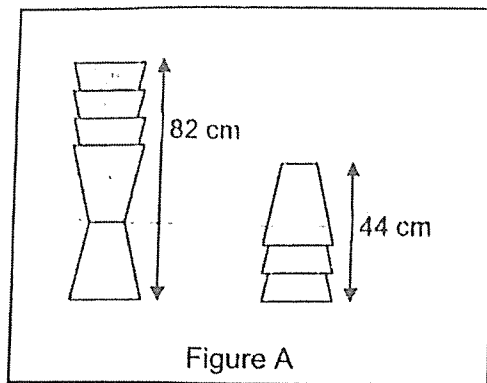

Find the height of the 6 stacked cups shown in Figure B.

Ans: \_\_\_\_\_ [5]

17. Nelson used some sticks to form some figures in a pattern. The first five figures are shown below.

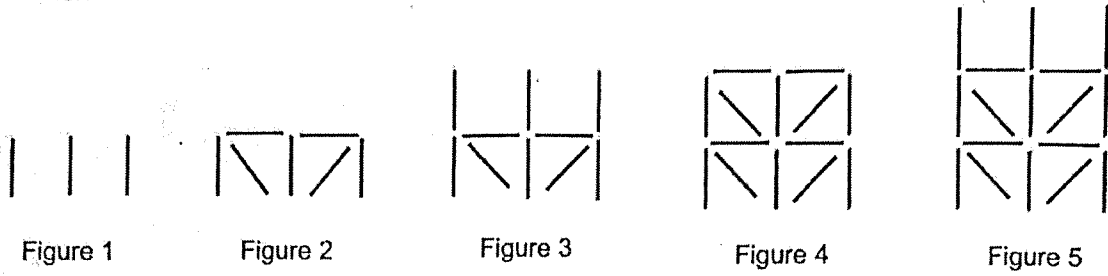

Figure Number	<del>Figure Number</del> No. of sticks
1	3
2	7
3	10
4	14
5	17
6	
7	

- (a) How many sticks are there in Figure 6 and 7? Complete the table above. [1]  
 (b) How many sticks are there in Figure 107?

Ans: (b) \_\_\_\_\_ [2]

- (c) Nelson used 2327 sticks to form a figure. Which Figure number did he form?

Ans: (c) \_\_\_\_\_ [2]

SCHOOL : HENRY PARK SCHOOL  
 LEVEL : PRIMARY 6  
 SUBJECT : MATH  
 TERM : WA2 2024

Q1	Q2	Q3	Q4	Q5	Q6	Q7	Q8	Q9	Q10
3	1	4	1	2	4	3	4	4	1
Q11	Q12	Q13	Q14	Q15					
3	2	1	4	2					

Q16) 9.28

Q17)  $\frac{43}{1000}$

Q18) 6h 45min

Q19)  $Ly = 180 - 136 = 44^\circ$

Q20) May and June

Q21) a)3675  
 b)6753

Q22) a)

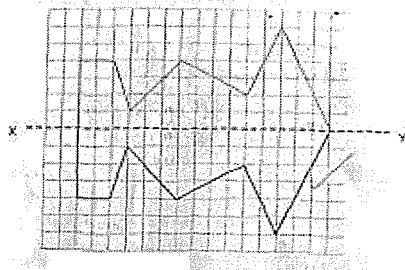

b)

(b) Draw a line perpendicular to EF, passing through point G.

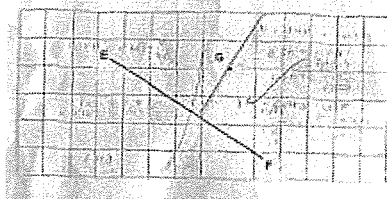





Q4)	$12.7 \times 3 = 38.1$ $38.1 - 16.8 = \$21.3$
Q5)	$140 + 112 = 252$ $\frac{252}{3} \times 2 = 168$
Q6)	a) $55 \times 6 = 330$ $330 - (35 + 55 + 30 + 45 + 60) = 105$ b) $1046.4 \div 109\% = 960$ $960 \div 30 = \$32$
Q7)	a) $\angle JAP = 180 - (65 + 48) = 67^\circ$ b) $54^\circ$
Q8)	$30 \div 5 = 6$ $24 \times 6 = 144$ $144 \div 5 = 28 \text{ R}4$ $\sim 28$
Q9)	a) $20 : 3 : 4$ b) $20 + 3 + 4 = 27$ $162 \div 27 = 6$ $20 - 3 = 17$ $17 \times 6 = 102$
Q10)	a) $\frac{1}{5} = \frac{3}{15}$ $\frac{2}{3} = \frac{10}{15}$ $1 - \frac{10}{15} = \frac{5}{15}$ $5 - 3 = 2$ $2u = 56$ $10u = 56 \times 5 = 280$ b) $16 \times 4 + 18 \times 12 = 280$ ANS ; 16
Q11)	$1932 \div 46 = 42$ $42 \times 3 = 126$
Q12)	$118 - (60 - 10) = 68$ $68 \div 80\% = 85$

Q13)	<p>a) <math>120 \div 4 = 30 \text{ cm}</math></p> <p>b) <math>(\frac{1}{4} \times \pi \times 30) - (\frac{1}{2} \times 30 \times 30) = 256.5</math>  <math>\frac{1}{4} \times \pi \times 60 + 256.5 = 3082.5 \text{ cm}^2</math></p>
Q14)	<p><math>80 \div 5 = 16</math></p> <p><math>16 \times 3 = 48</math></p> <p><math>16 \times 4 = 64</math></p> <p><math>64 \times 80 \times 48 = 245\,760 \text{ cm}^3</math></p>
Q15)	<p>a) <math>\angle t = 90 - (20 + 45) = 25^\circ</math></p> <p>b) <math>\angle p = 45 - 25 = 20^\circ</math></p>
Q16)	<p><math>1c + 1p = 82 - 44 = 38</math></p> <p><math>1p = 44 - 38 = 6</math></p> <p><math>6 \times 3 + 44 = 18 + 44 = 62 \text{ cm}</math></p>
Q17)	<p>a) 21, 24</p> <p>b) <math>107 - 1 = 106</math>  <math>106 \div 2 = 53</math>  <math>53 \times 7 = 371</math>  <math>371 + 3 = 374</math></p> <p>c) <math>2327 \div 7 = 332 \text{ R}3</math>  <math>332 \times 2 = 664</math>  <math>664 + 1 = 665</math></p>