

Red Swastika School
Primary 5
Class Test 1
Mathematics

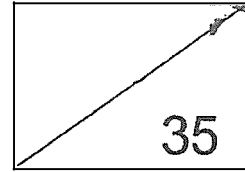

Name: _____ () Date: 6 May 2024

Class: Pr 5 / _____ Duration: 45 minutes
(Use of calculators is not allowed)

Parent's Signature: _____ *g*

Questions 1 to 2 carry 1 mark each. Questions 3 to 5 carry 2 marks each. For each question, four options are given. One of them is the correct answer. Make your choice (1, 2, 3 or 4) and write its number in the brackets provided. (8 marks)

1 $50\,000 + 400 + 10 + 3 =$ _____

- (1) 5413
- (2) 50 413
- (3) 54 013
- (4) 54 130

()

2 Round 15 849 to the nearest hundred.

- (1) 15 800
- (2) 15 840
- (3) 15 850
- (4) 15 900

()

3 Which of the following is **not** a common factor of 16 and 36?

- (1) 1
- (2) 2
- (3) 3
- (4) 4

()

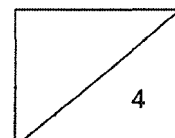

4 Express $\frac{4}{20}$ as a decimal.

- (1) 0.04
- (2) 0.20
- (3) 0.25
- (4) 0.40

()

5 Which of the following fractions is closest to $\frac{1}{2}$?

- (1) $\frac{2}{3}$
- (2) $\frac{3}{5}$
- (3) $\frac{3}{7}$
- (4) $\frac{5}{9}$

()

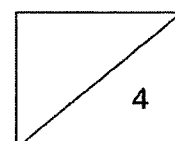

Questions 6 to 13 carry 2 marks each. Write your answers in the spaces provided.
For questions which require units, give your answers in the units stated. (16 marks)

6 (a) Find the value of $4 + 8 \div (1 + 3)$

Ans: (a) _____

(b) Use all the digits 3, 4, 5, 6 to form a number closest to 4000.

Ans: (b) _____

7 Find the value of

(a) $\frac{2}{5} + \frac{1}{2}$

(Express your answer in its simplest form)

Ans: (a) _____

(b) $\frac{6}{7} \times 4$

(Express your answer as a mixed number)

Ans: (b) _____

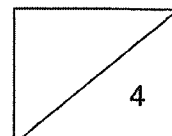

- 8 John had 3600 g of sugar and he used 300 g of sugar each day. How many days would John take to finish using all his sugar?

Ans: _____

- 9 In the figure below, the rectangle and square have the same area. Find the length of one side of the square.

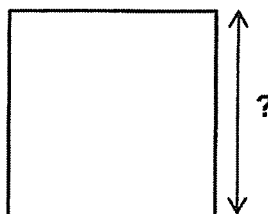
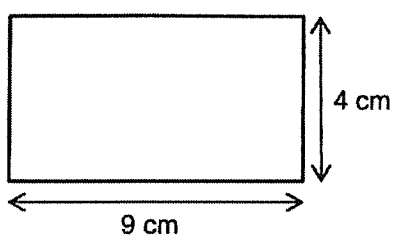

Ans: _____ cm

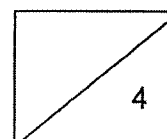

4

- 10 There are 30 boys and 10 girls in a class. $\frac{3}{5}$ of the boys and none of the girls wear spectacles. What fraction of the students in the class wear spectacles? (Leave your answer in its simplest form)

Ans: _____

- 11 (a) In the number line, what is the fraction represented by A?

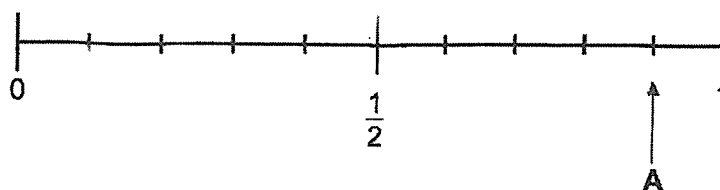

Ans: (a) _____

- (b) PQRS is a square. The shaded parts A and B are two squares with different areas. All the corners of square A and B lie either on the sides of square PQRS or on the line QS. What fraction of the square is shaded?

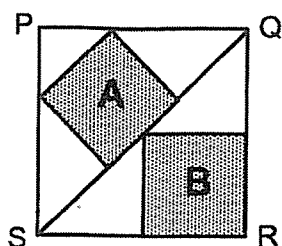

Ans: (b) _____

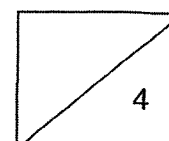

- 12 The numbers in the table below follow a certain pattern. Study the pattern carefully and answer the question.

	Column A	Column B	Column C	Column D
Row 1	3	2	1	0
Row 2	4	5	6	7
Row 3	⋮	⋮	9	8
⋮	⋮	⋮	⋮	⋮

In which column will the number 65 appear?

Ans: Column _____

- 13 The figure below is made of a square, a rectangle and two triangles. The height of triangle ABH is twice the height of triangle ABE.

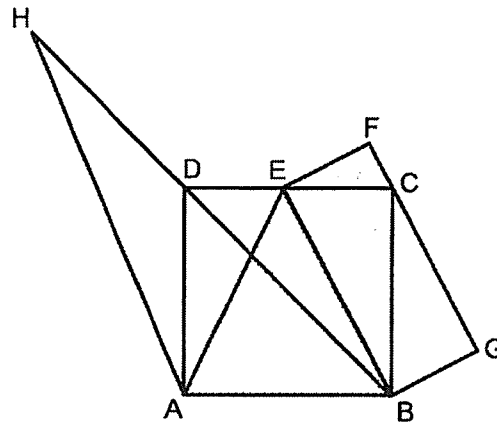

Each of the statements below is either true, false, or not possible to tell from the information given. For each statement, put a tick (✓) to indicate your answer.

Statement	True	False	Not possible to tell
Triangle ABH has the same area as square ABCD			
Area of triangle ABH is half the area of triangle ABE			
The area of rectangle BEFG is half the area of triangle ABH			

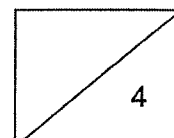

For Questions 14 and 16, show your workings clearly in the space below each question and write your answers in the spaces provided. The number of marks available is shown in brackets [] at the end of each question or part-question. (11 marks)

- 14 The figure below is made up of square ABCD and two overlapping triangles CDE and CDF.

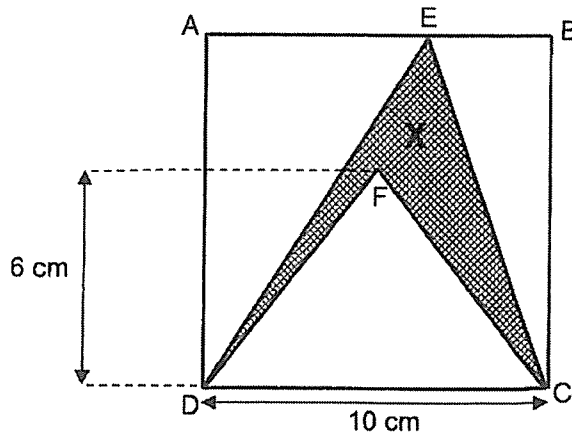

- (a) What is the area of triangle CDE?

Ans: (a) _____ [1]

- (b) What is the area of shaded part X?

Ans: (b) _____ [2]

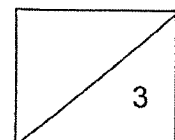

- 15 Mr Goh had 260 apples and oranges at first. He sold $\frac{1}{4}$ of the apples and $\frac{2}{3}$ of the oranges in the morning and had the same number of each fruit left. He then sold $\frac{1}{5}$ of the remaining oranges in the afternoon.

(a) Which type of fruit did Mr Goh have more at first?

Ans: (a) _____ [1]

(b) How many oranges did Mr Goh sell in the afternoon?

Ans: (b) _____ [3]

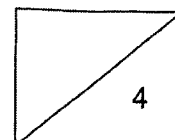

16 Susan had an equal number of red and blue beads. She gave 35 red beads and 13 blue beads to Jenny. She gave the remaining beads to Tom. Tom received three times as many blue beads as red beads.

(a) How many more red beads than blue beads did Susan give to Jenny?

Ans: (a) _____ [1]

(b) Who received more beads from Susan? How many more?

Ans: (b) _____, _____ more [3]

End of paper

Have you checked your work?

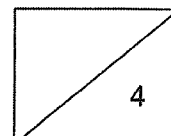

SCHOOL : RED SWSATIKA SCHOOL
 LEVEL : PRIMARY 5
 SUBJECT : MATH
 TERM : 2024 WA1

Q1)	2
Q2)	1
Q3)	3
Q4)	2
Q5)	4
Q6)	a)6 b)3654
Q7)	a) $\frac{9}{10}$ b) $3\frac{3}{7}$
Q8)	12
Q9)	6cm
Q10)	$\frac{9}{20}$
Q11)	a) $\frac{9}{10}$ b) $\frac{17}{36}$
Q12)	C
Q13)	True False Not possible to tell
Q14)	a)30 cm ² b)20 cm ²
Q15)	a)oranges b)12
Q16)	a)22 b)Jenny , 4 more

