



AI TONG SCHOOL

2024 END-OF-YEAR EXAMINATION PRIMARY FOUR SCIENCE

(BOOKLET A)

21 OCTOBER 2024

Total time for booklets A and B : 1 h 45 min

INSTRUCTIONS

Do not turn over this page until you are told to do so.

Follow all instructions carefully.

Answer all questions.

Name : _____ ()

Class : Primary 4 _____

Parent's Signature :

Booklet A	56
Booklet B	44
Total	100

Section A (28 x 2 marks)

For each question from 1 to 28, four options are given. One of them is the correct answer. Make your choice and shade the correct oval (1, 2, 3 or 4) on the Optical Answer Sheet.

1. Jane learns that all living things need air, water and food to stay alive. Which set-up can she use to keep her grasshopper alive?

(1)

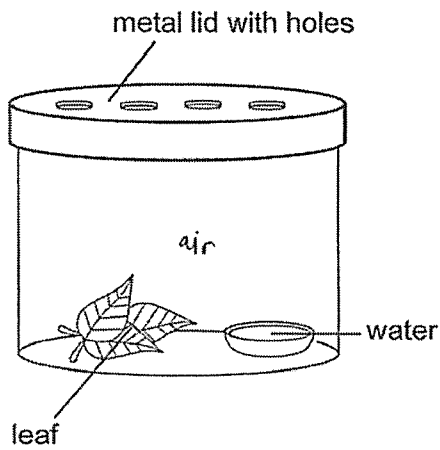

(2)

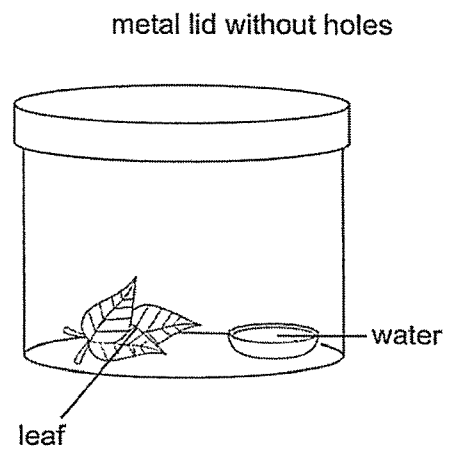

(3)

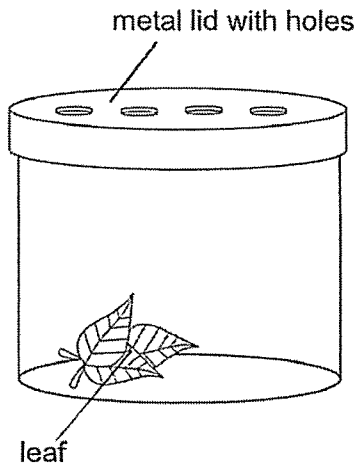

(4)

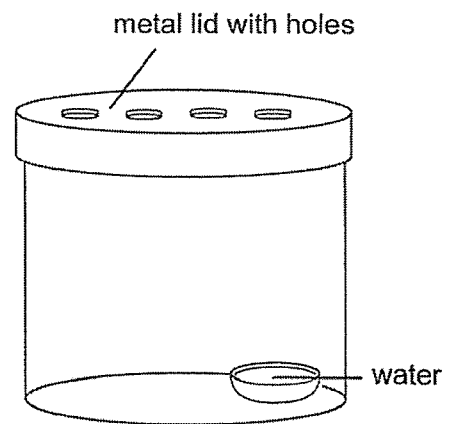

2. Freddy made the following observations on the life cycle of an animal.

- There are three stages in the life cycle.
- The young looks like the adult.

Which animal was Sam observing?

- (1) frog
- (2) beetle
- (3) mosquito
- (4) cockroach

3. Which part, (1), (2), (3) or (4), makes food for the plant?

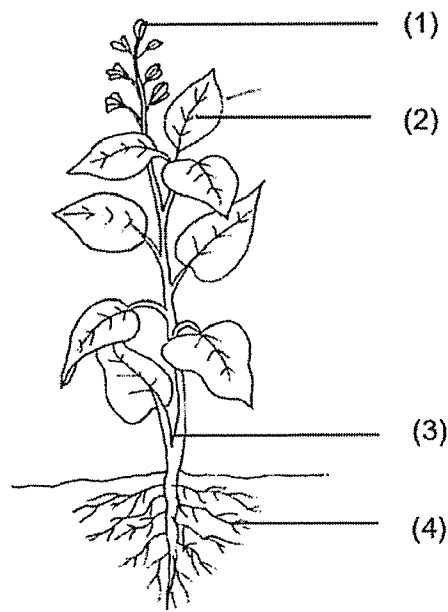

A - 2

4. Which human system is shown in the diagram?

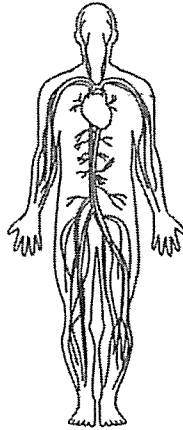

- (1) skeletal system
- (2) digestive system
- (3) circulatory system
- (4) respiratory system

5. The diagram shows a painting hanging on a wall.

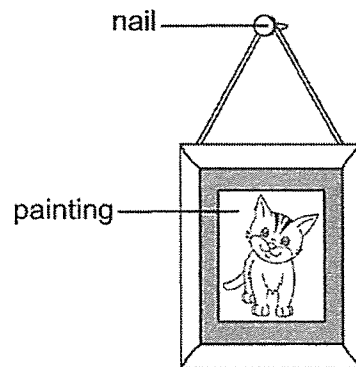

Iron is used to make nails because iron _____.

- (1) is shiny
- (2) is strong
- (3) sinks in water
- (4) conducts heat well

A - 3

6. Matter is anything that has mass and occupies space.
Which of the following is **not** matter?

- (1) air
- (2) soil
- (3) water
- (4) shadow

7. Ravi pumps air into a float.

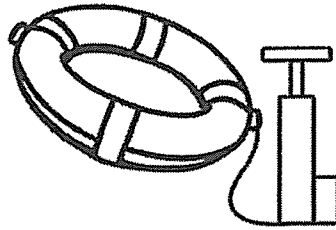

More air can be pumped into the float even though it is already filled with air. This is because air _____.

- (1) is matter
- (2) has a fixed shape
- (3) does not have a fixed mass
- (4) does not have a fixed volume

8. Object A was attracted to a magnet, as shown in the figure below.

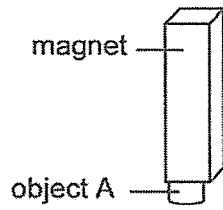

Object A is made of _____.

- (1) steel
- (2) wood
- (3) rubber
- (4) plastic

|

9. Warm water at 70 °C is mixed with cold water at 10 °C.

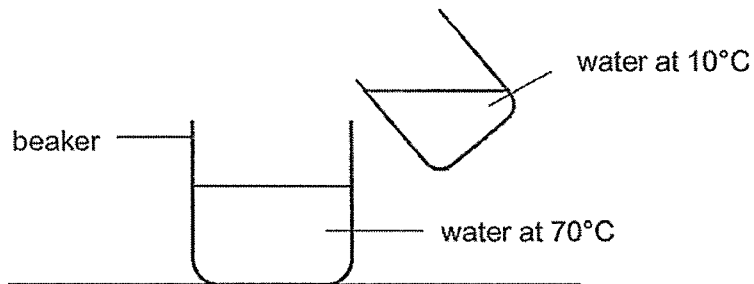

What is a possible final temperature of water in the beaker?

- (1) 75 °C
- (2) 70 °C
- (3) 50 °C
- (4) 10 °C

10. Look at the picture below.

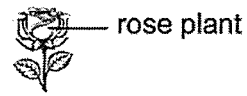
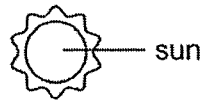

Which one of the following explains why Mrs Ong can see the rose plant in the garden?

—————→ direction of light

(1)

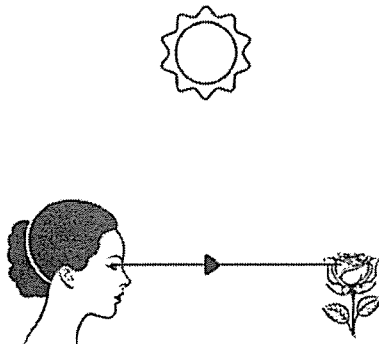

(2)

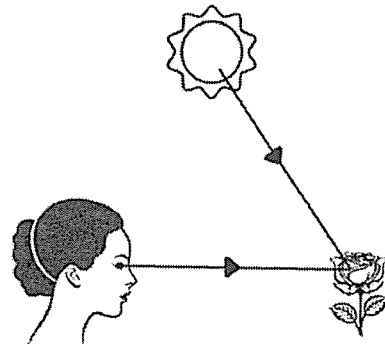

(3)

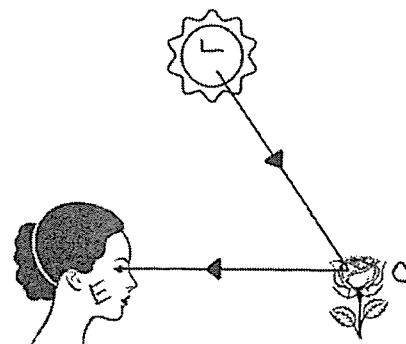

(4)

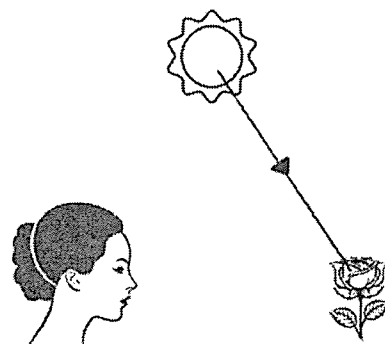

A - 6

11. Study the flowchart below.

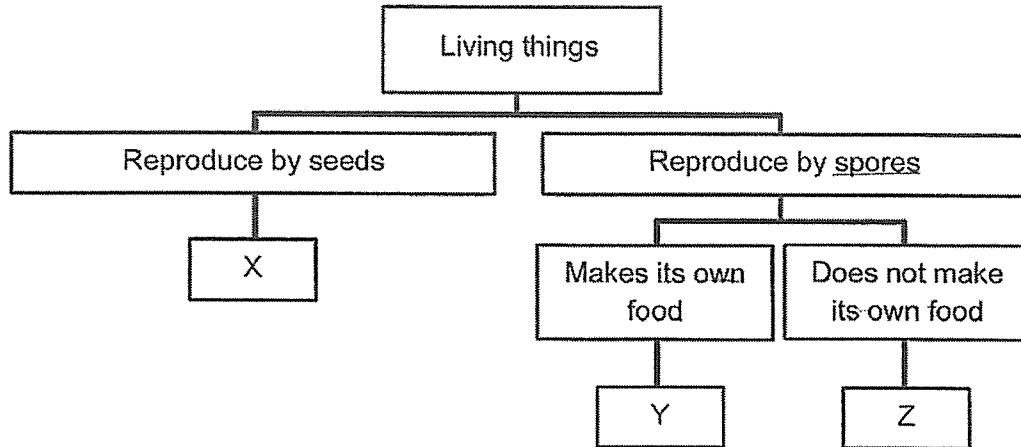

Based on the flowchart above, which of the following is possible?

	Plant	Fungi
(1)	X	Y
(2)	Y	Z
(3)	Y	X
(4)	Z	X

12. Study the picture of the plants shown below.

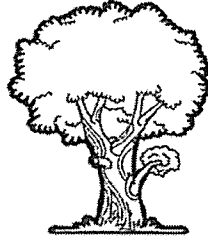

The stems of these plants are different but have a common function.
Which of the following statement(s) is/are correct about the common function?

- S** To hold the plant firmly in the soil.
- T** To support and keep the plant upright.
- U** Hold the leaves up so that they can get sunlight.
- V** Transport water made in the leaves to all parts of the plant.

- (1) S only
- (2) S and T only
- (3) T and U only
- (4) T, U and V only

13. Matthew wanted to investigate if the type of food affects the time taken for it to be digested completely. Which of the following should Matthew do in his investigation to achieve his aim?

- A** Use the same amount of different types of food.
- B** Use the same amount and type of digestive juice.
- C** Cut the same amount of food into different sizes for each set-up.
- D** Ensure that the time taken for each type of food to be digested completely is the same.

- (1) A and B only
- (2) A and D only
- (3) B and C only
- (4) C and D only

14. X, Y and Z are samples of the same food taken from different parts of the digestive system.

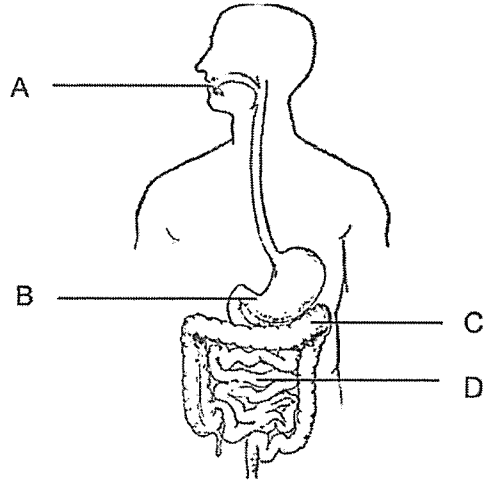

From which part of the digestive system could samples X, Y and Z be taken from?

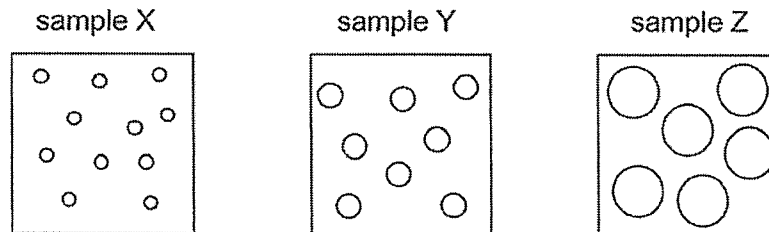

	Sample X	Sample Y	Sample Z
(1)	A	B	C
(2)	B	C	A
(3)	C	A	B
(4)	D	B	A

15. Gopal carried out an experiment as shown in the diagram below. He repeatedly dropped a 3-kg weight from a fixed height onto material A until it broke.

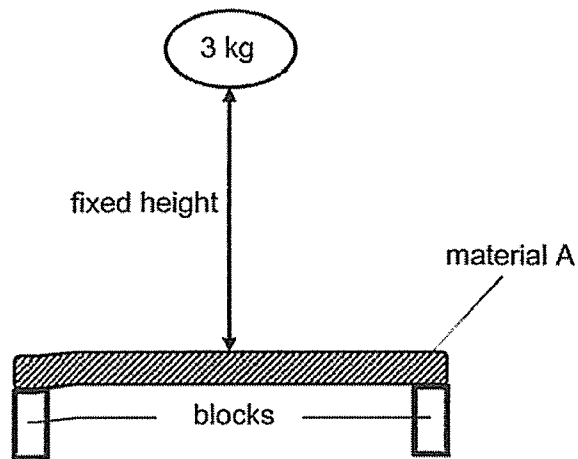

Gopal recorded the number of times the 3-kg weight was dropped before the material broke in the table below. He then repeated the experiment using materials B, C and D.

Material	Number of times the 3-kg weight was dropped before material broke
A	10
B	5
C	25
D	27

Based on the results above, which statement is true?

- (1) Material A is weaker than material C.
- (2) Material C is stronger than material D.
- (3) Material D will break first if a heavy load was placed on it.
- (4) Material B is the best material to choose to make into a table top.

16. The table below shows the properties of materials E, F, G and H.
A tick (✓) shows that the material has the property.

Material	Waterproof	Transparent	Flexible
E		✓	
F	✓	✓	
G	✓		✓
H	✓		

Which of the materials, E, F, G or H, will you choose to make a raincoat?

- (1) E
(2) F
(3) G
(4) H
17. The characteristics of three things, X, Y and Z, are given in the table below.
A tick (✓) shows that the thing has the characteristic.

Thing	Has definite shape	Has definite volume	Has mass
X	✓	✓	✓
Y		✓	✓
Z			

Which of the following statements is **not** correct?

- (1) Z is a gas.
(2) X is a solid.
(3) Y is a liquid.
(4) Only X and Y are matter.

18. Two boxes, G and H, attached to a pump, have the same capacity of 1000 cm^3 each. A ball of plasticine of volume 200 cm^3 was placed inside box H. Both boxes are then sealed with an air-tight cover.

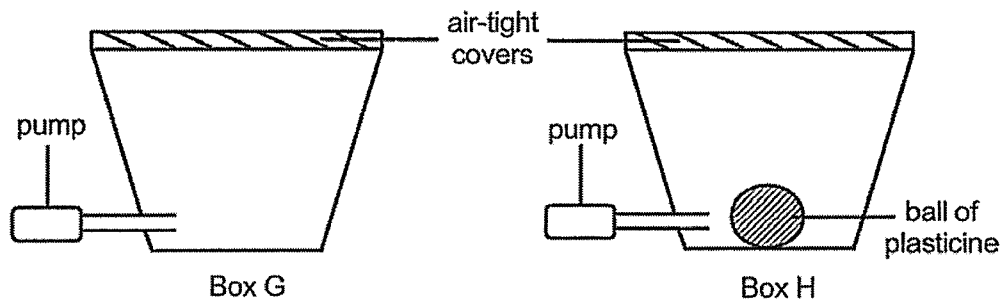

An additional 500 cm^3 of air was pumped into box G and 300 cm^3 of air was pumped into box H. Which of the following shows the final volume of air in each box?

	Final volume of air in the box (cm^3)	
	Box G	Box H
(1)	1000	800
(2)	1000	1100
(3)	1500	1300
(4)	1500	1800

19. A group of students conducted an experiment to find out the volume of objects M, N, P and Q. The diagrams below show what they did.

Diagram 1: Objects were placed in water.

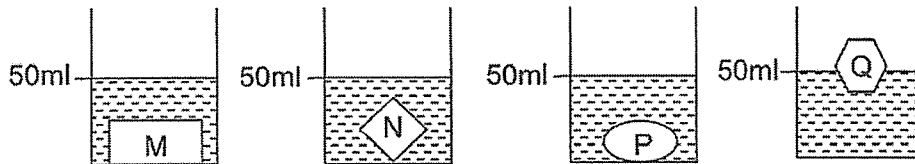
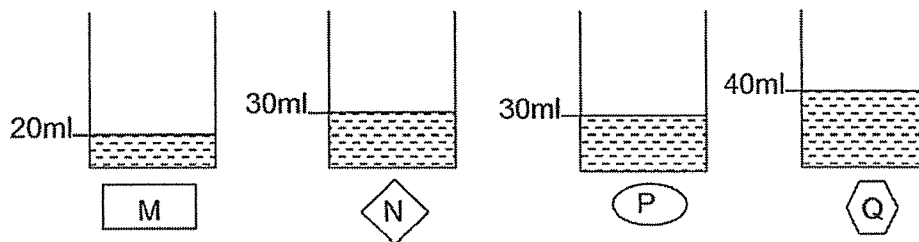

Diagram 2: Objects were taken out of the water.



Based on the diagrams above, which of the following statements is correct?

- (1) Object P has a volume of 30 cm^3 .
- (2) Object Q has the greatest volume.
- (3) Objects N and P have the same mass.
- (4) Object M has a greater volume than object P.

20. When object A is placed near point X of object B, they move towards each other.

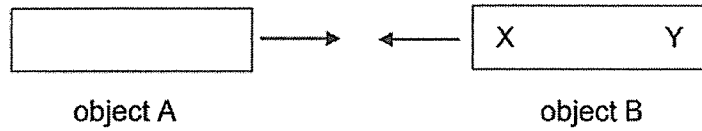

When object A is placed near point Y of object B, they move away from each other.

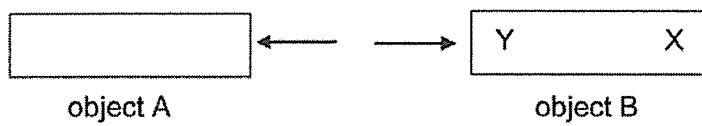

Which of the following statements are true about objects A and B?

- A Only object B is a magnet.
- B Object A is made of copper.
- C Both objects A and B are magnets.
- D Object B is made of a magnetic material.

- (1) A and B only
- (2) A and D only
- (3) B and C only
- (4) C and D only

21. Lilian set up an experiment using four bar magnets, A, B, C and D. She placed each magnet above a steel paper clip tied to a weight by a string. The magnet pulled the paper clip up. She measured and recorded the maximum distance, d , between the bar magnet and the paper clip before the paper clip dropped.

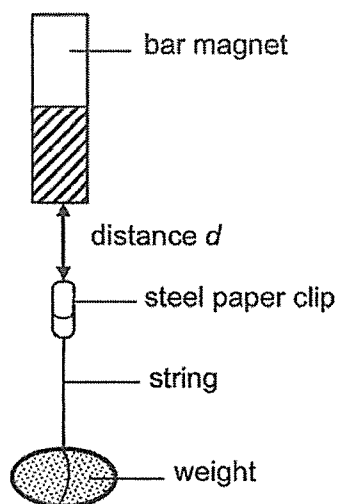

Magnet	Distance d (cm)
A	2
B	7
C	11
D	4

Based on the results, which of the following correctly shows the order of the strength of magnets, starting from the weakest to the strongest?

	Weakest	—————→			Strongest
(1)	A	D	B	C	
(2)	B	A	C	D	
(3)	C	B	D	A	
(4)	D	C	B	A	

22. Four students set up an experiment to measure the amount of light passing through four different objects, R, S, T and U, as shown in the diagram.

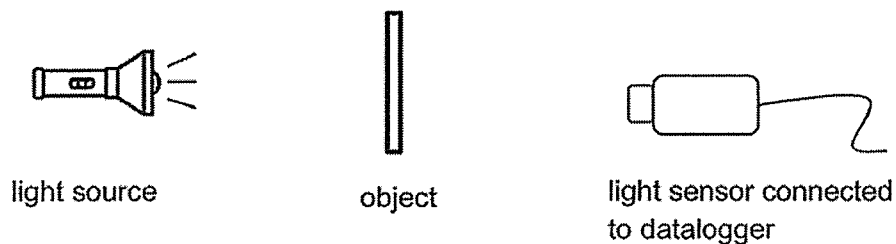

The amount of light that can pass through each object was measured and recorded in the table below.

Object	Amount of light recorded (unit)
R	200
S	0
T	75
U	500

Based on the results, some students drew the following conclusions.

- Ali** Object R blocks more light than object T.
- Bala** Object S does not allow light to pass through.
- Carol** Only objects R, T and U allow light to pass through.
- Danny** Object U allows least amount of light to pass through.

Which of the statement(s) made by the students is/are definitely true?

- (1) Ali only
- (2) Ali and Bala only
- (3) Bala and Carol only
- (4) Carol and Danny only

23. Lisa is walking under a street lamp at night as shown below.

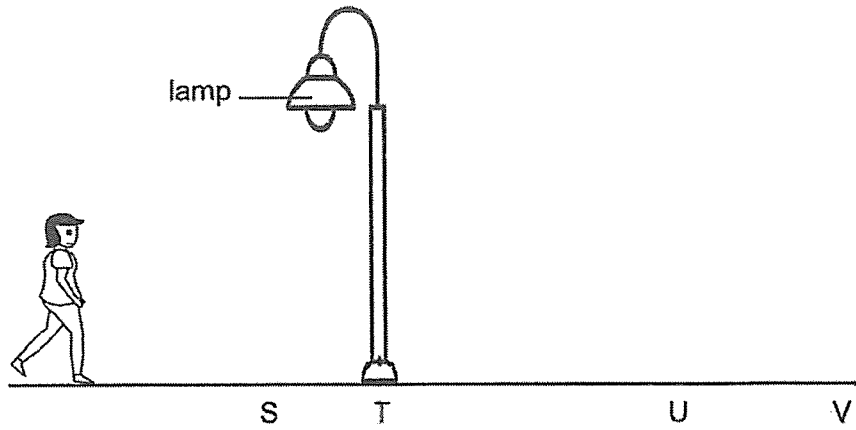

The graph below shows the length of Lisa's shadow taken at different positions. Shadows A, B, C and D shown in the graph are **not** matched to positions S, T, U and V.

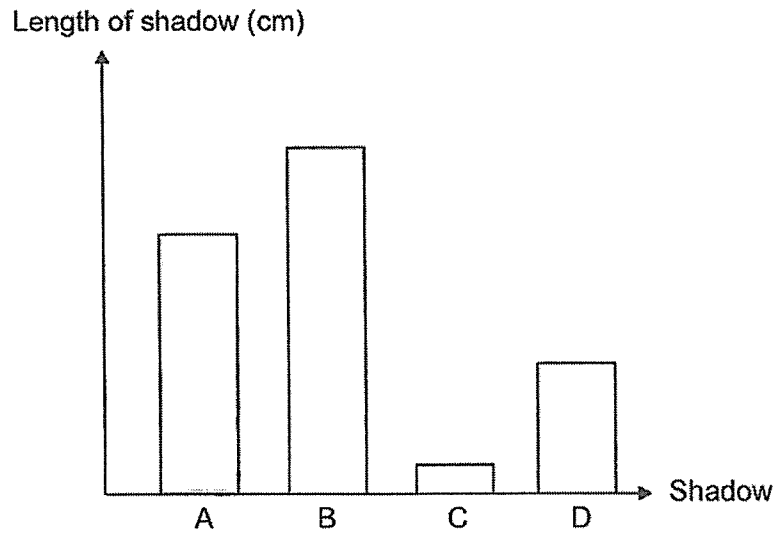

Which shadow, A, B, C or D, shows that Lisa was at position U?

- (1) A
- (2) B
- (3) C
- (4) D

24. The diagram below shows three shapes, a square, a star and a circle, each made of different materials.

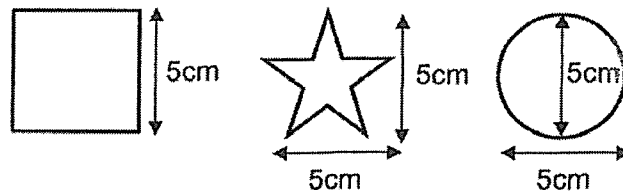

The three cut-outs were then hung from a fixed height in between the torch and a white screen at different positions A, B and C. When the torch was switched on, a shadow was cast on the screen as shown in the diagram below.

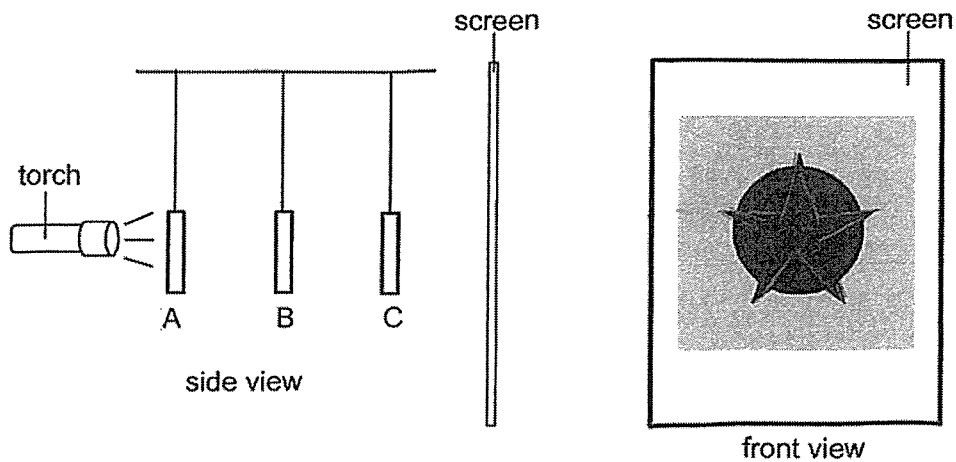

Based on the observation of the shadow formed on the screen, which of the following statements is correct?

- (1) The circle is nearer to the torch than the star.
- (2) The square is further from the torch than the star.
- (3) The star allows less light to pass through than the circle.
- (4) The square allows more light to pass through than the circle.

25. A bowl of hot soup was left in a room for 35 minutes.—
The graph shows how the temperature of the soup changed over time.

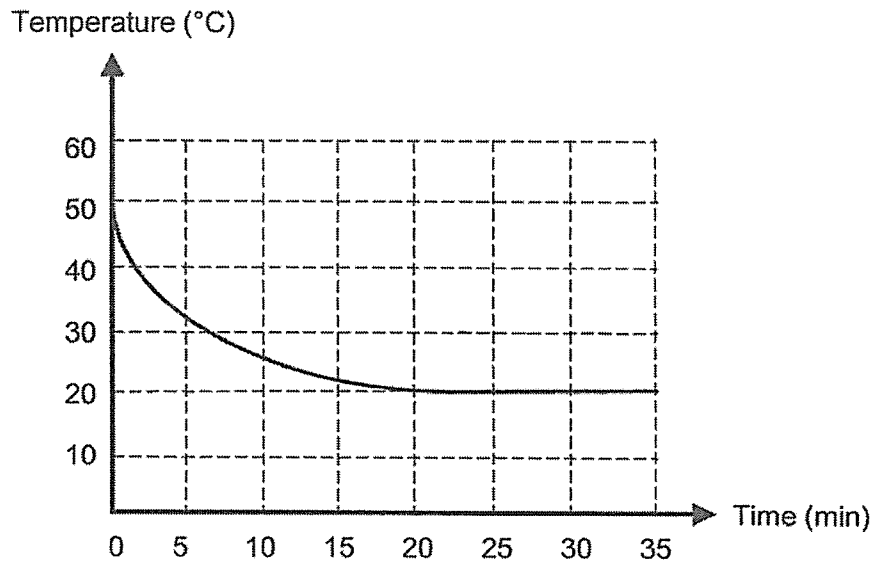

What was the temperature of the room?

- (1) 20 °C
- (2) 30 °C
- (3) 40 °C
- (4) 50 °C

26. The diagram below shows what happened before and after an iron ball was heated.

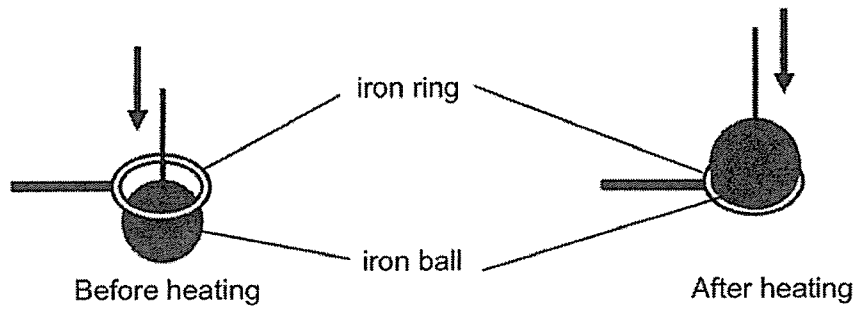

What could be done so that the iron ball can pass through the iron ring again?

- A Place the iron ball in a beaker of ice water.
- B Place the iron ring in a beaker of ice water.
- C Place the iron ball in a beaker of boiling water.
- D Place the iron ring in a beaker of boiling water.

- (1) A and B only
- (2) A and D only
- (3) B and D only
- (4) C and D only

27. Mary took a thick glass out of a refrigerator and immediately poured some boiling water into it. She observed cracks forming in the inner side of the glass after she poured the boiling water.

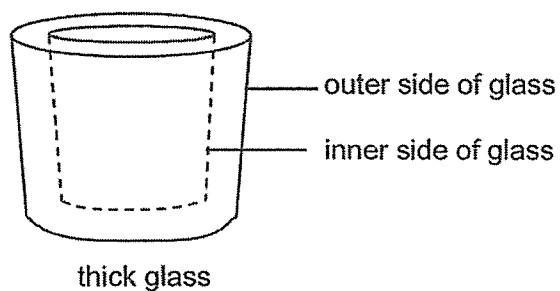

Why did the inner side of the glass crack when Mary poured boiling water in it?

- (1) The air inside the glass expanded.
- (2) The outer side of the glass expanded faster than the inner side of the glass.
- (3) The inner side of the glass expanded faster than the outer side of the glass.
- (4) The outer side of the glass contracted faster than the inner side of the glass.

28. The diagram below shows a square metal frame with four drops of wax. A heat source was placed at point X.

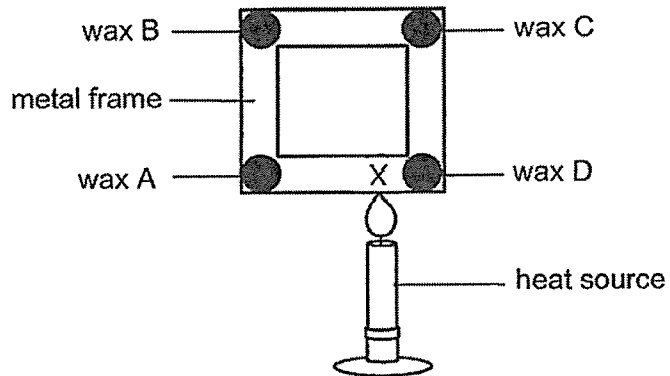

Which of the following correctly shows the order in which the drops of wax melted, starting from the fastest to the slowest?

	Fastest → Slowest			
(1)	A	B	C	D
(2)	A	D	B	C
(3)	D	C	B	A
(4)	D	A	C	B



AI TONG SCHOOL

2024 END-OF-YEAR EXAMINATION PRIMARY FOUR SCIENCE

(BOOKLET B)

21 OCTOBER 2024

Total time for booklets A and B : 1 h 45 min

INSTRUCTIONS

Do not turn over this page until you are told to do so.

Follow all instructions carefully.

Answer all questions.

Write your answers in this booklet.

Name : _____ ()

Class : Primary 4 _____

Parent's Signature : _____

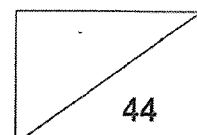

Section B: 44 marks

Read the questions carefully and write down your answers in the spaces provided.

29. A, B, C and D are the various stages in the life cycle of a butterfly.

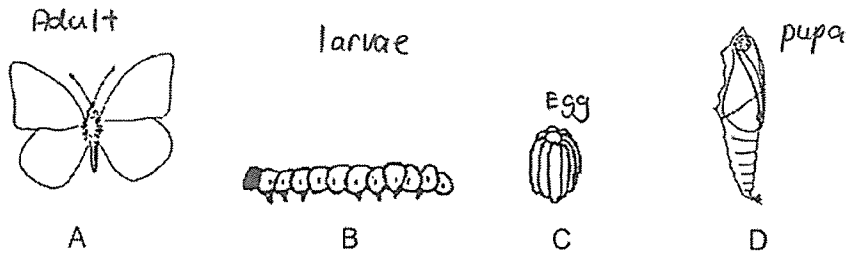

(a) Arrange A, B, C and D in the correct order of the life cycle. C has been included in the box below. [1]

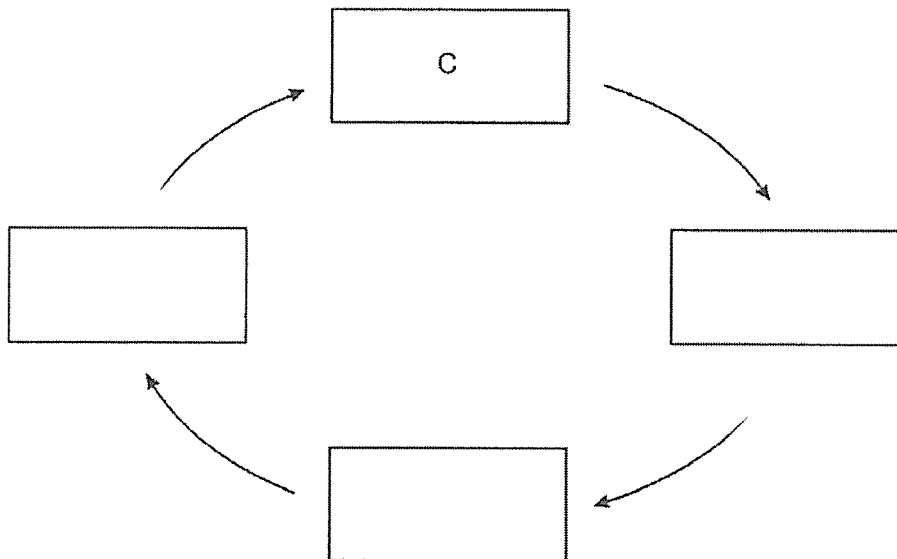

(b) At stage _____, it eats a lot. [1]

B - 1

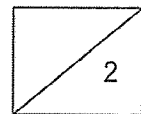

30. The diagram below shows a frying pan.

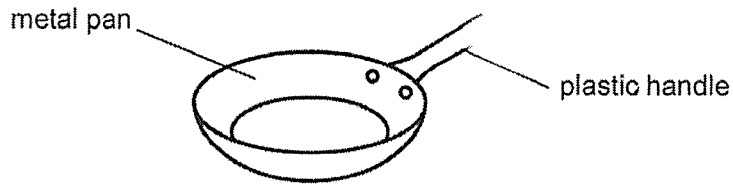

- (a) The handle is made of plastic because it is a _____ conductor of heat. [1]
- (b) The pan is made of metal because it is a _____ conductor of heat. [1]

31. (a) Magnet Q is brought near another magnet P.

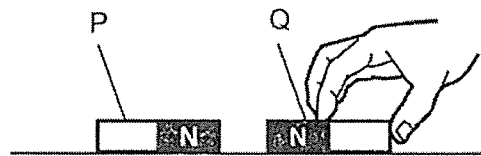

As the same poles of both magnets are facing each other, P and Q will _____ [1]

(b) Q is then brought near a small iron ball.

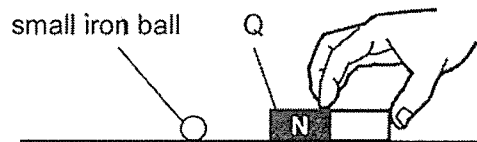

Tick (✓) the box that shows the direction the iron ball will move. [1]

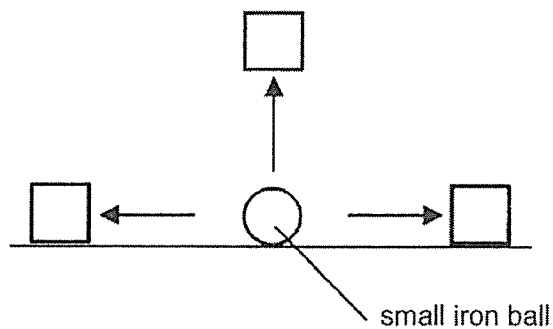

B - 2

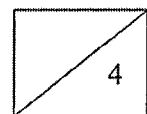

32. Look at the animal below.



Characteristics

(a) Which statements explain why it is an insect? Tick (✓) **two** correct boxes. [2]

	It can fly.
	It has wings.
	It has six legs.
	It has three body parts.

The flowchart below shows the characteristics of four animals P, Q, R and S.

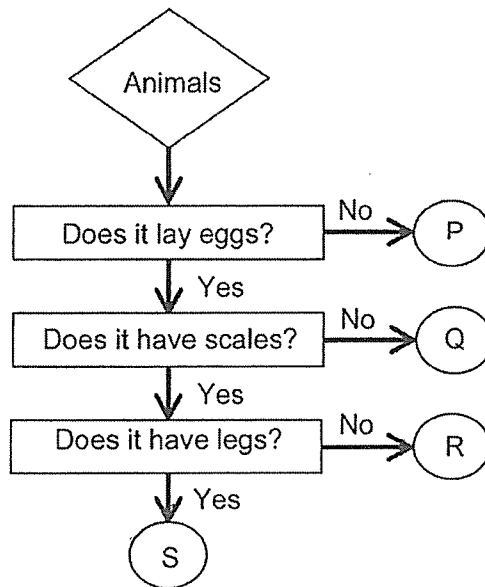

(bi) Based on the flowchart, state one similarity between animals R and S. [1]

Question 32 continues on the next page.

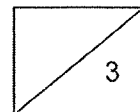

Question 32 continues on this page.

The diagram below shows animal X.

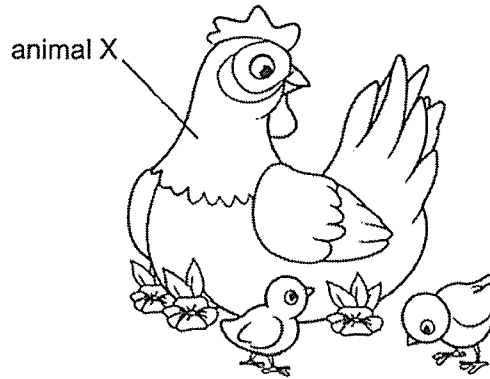

- (bii) Pei Pei studied the flowchart and concluded that animal X belongs to the same animal group as animal S. Do you agree with Pei Pei? Explain your answer. [1]

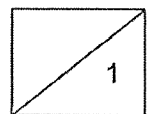

33. Farah observed two plants, S and T, as shown below.

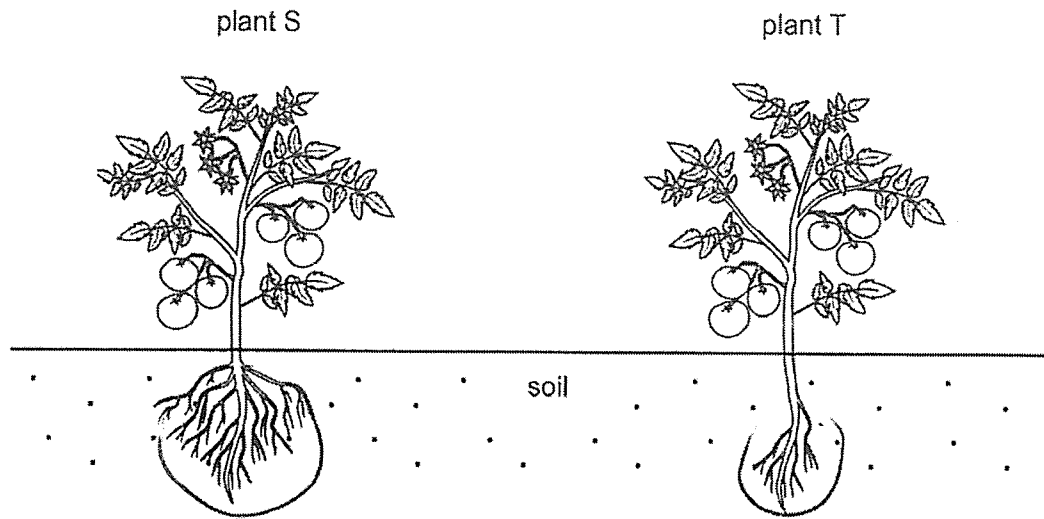

- (a) Based on the diagram above, which stage of the life cycle are both plants at?
Explain your answer. [1]

- (b) Which plant, S or T, is most likely to be uprooted first during a storm?
Explain your answer. [1]

Question 33 continues on the next page.

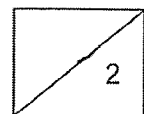

Question 33 continues on this page.

Farah noticed that her morning glory plant was growing on a pole as shown below.

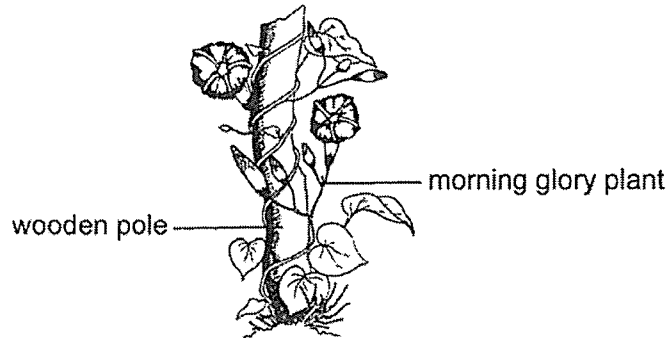

- (c) From Farah's observation, what can she conclude about the stem of this plant? [1]

The diagram below shows the leaf of a morning glory plant.

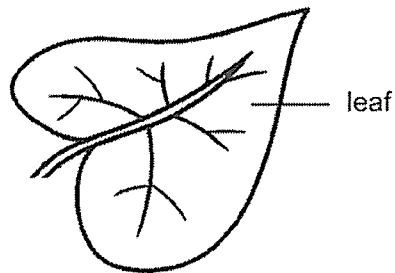

- (d) Describe the leaf edge of the morning glory plant. [1]

B - 6

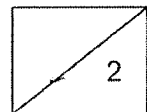

34. Aini conducted an experiment to find out about the human digestive system. She measured and recorded the amount of digested food found in the various parts as the food travels down the digestive system.

Part in the system	Mouth	Gullet	Stomach	Small intestine	Large intestine
Amount of digested food (g)	2	10	18	32	?

- (a) One of the data was recorded wrongly. At which part of the digestive system was the data recorded wrongly? Explain your answer. [2]

- (b) What is the amount of digested food found in the large intestine? Explain your answer. [2]

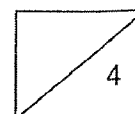

35. Martha places a toy boat in water. The toy boat stays on the surface of water.

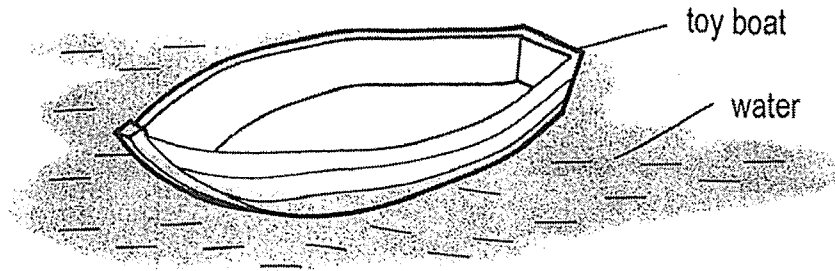

(a) This shows that the toy boat _____ on water. [1]

(b) Circle the correct answer. [1]

Water cannot enter the boat because it is made of a
 (*flexible* / *strong* / *waterproof*) material.

Martha then conducted another two experiments using three different strips of materials, P, Q, and R, as shown below. The materials are of the same length and thickness.

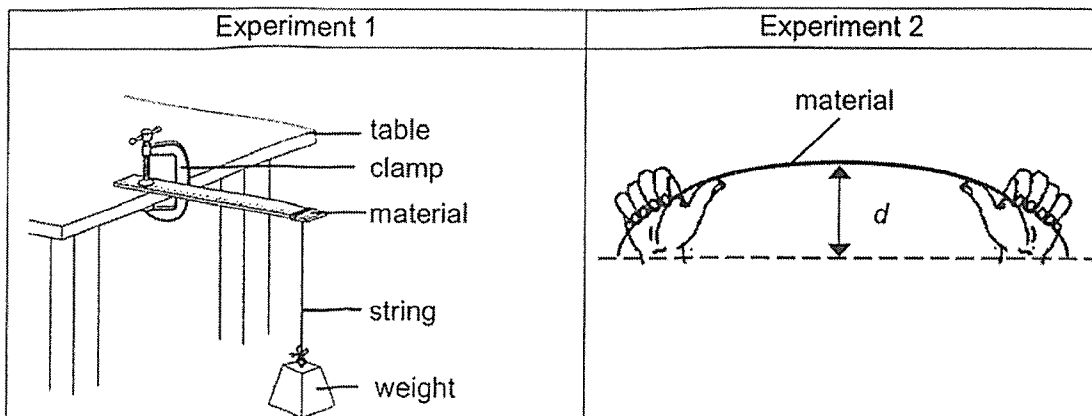

Question 35 continues on the next page.

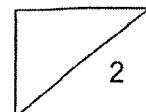

Question 35 continues on this page.

The table below shows the total mass of weights each material could hold and the maximum distance, d , each material can bend before it broke.

	Experiment 1	Experiment 2
Material	Total mass of weights before it broke (kg)	Maximum distance, d (cm)
P	4	0
Q	9	5
R	17	13

- (c) Based on the results obtained from the two experiments, which material, P, Q or R, is most suitable for making the string for flying a kite? Explain your answer. [2]

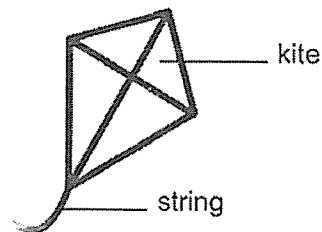

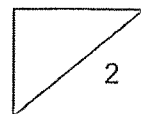

36. Three identical flasks were filled with equal volumes of water at 90°C. The flasks were wrapped with different materials, E, F and G.

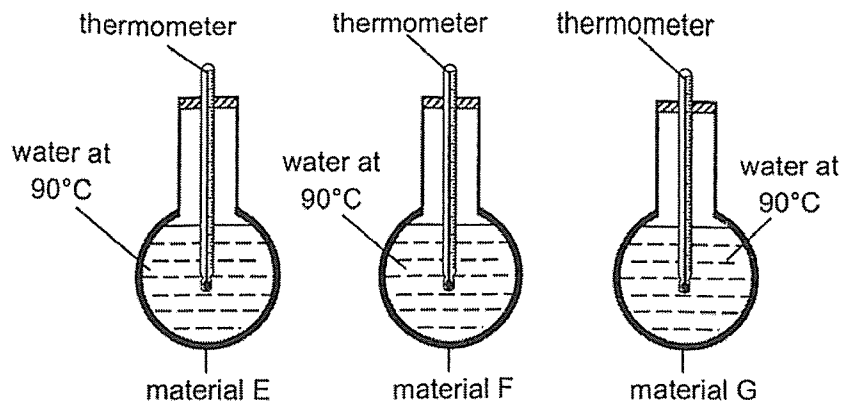

The temperature of the water in each flask was measured and recorded at the end of 30 minutes. The results are shown in the table below.

(1)

Material	Temperature of water at the start (°C)	Temperature of water after 15 minutes (°C)	Temperature of water after 30 minutes (°C)
E	90	75	54
F	90	65	40
G	90	81	79

- (a) Based on the results obtained, state what happen to the temperature of water in all three flasks at the end of the experiment. [1]

Question 36 continues on the next page.

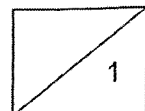

Question 36 continues on this page.

- (b) Based on the results obtained, which material, E, F, or G, would be most suitable for making a winter jacket that can keep us the warmest in a cold country?

Explain your choice.

[2]

- (c) A winter jacket also contains feathers which trap air. Explain how this also helps to make the jacket suitable for keeping us warm.

[1]

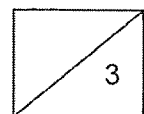

37. Sam conducted an experiment in a dark room to find out the amount of light reflected by four different materials, A, B, C and D.

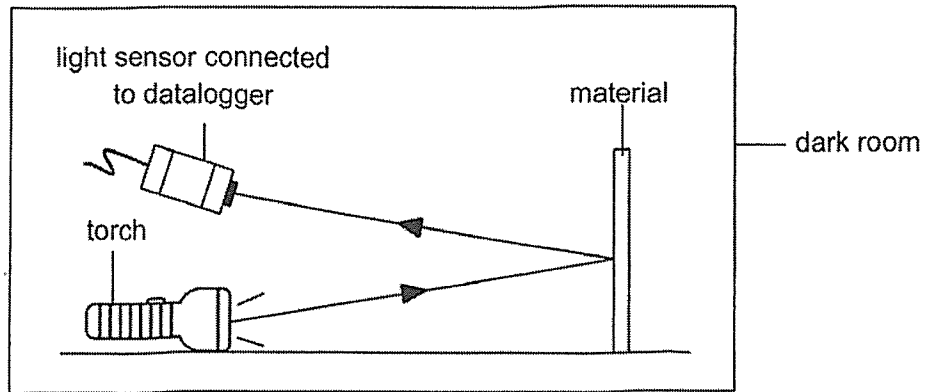

The results were recorded in the table shown below.

Material	A	B	C	D
Amount of light reflected (units)	30	70	50	120

Sam wants to make a safety vest that he can use while jogging at night in the park.

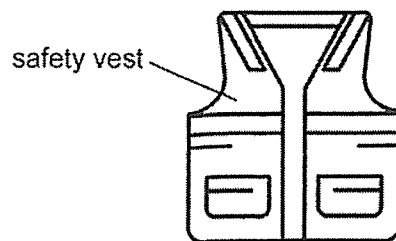

- (a) Based on the results of the experiment, which material, A, B, C or D, is most suitable for making the safety vest? Explain your answer. [2]

Question 37 continues on the next page.

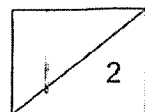

Question 37 continues on this page.

37. (b) How does conducting the experiment in a dark room help Sam ensure that the readings are accurate? [1]

Sam conducted another experiment using the same set-up to find out if darker colours reflect more or less light.

He used the material chosen in part (a) and painted it in four different colours. The amount of reflected light detected by the light sensor for each colour was recorded in the bar graph below.

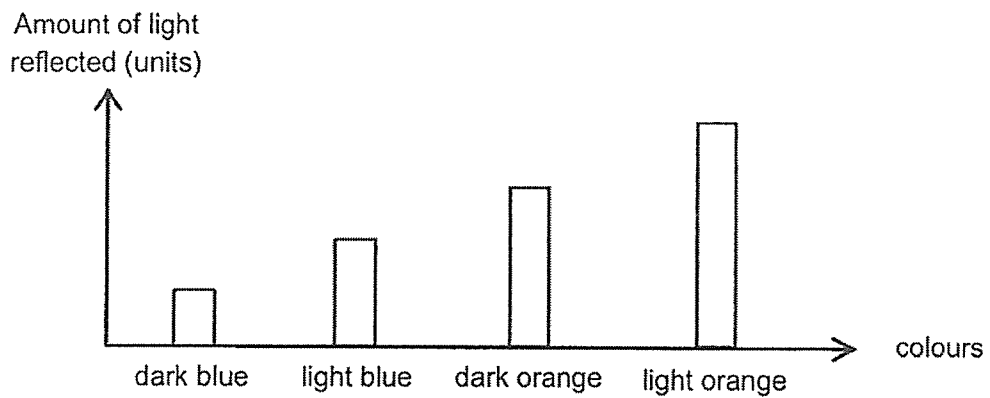

- (c) What can Sam conclude from his experiment? [1]

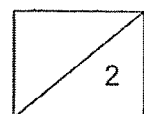

38. Gabriel set up a stage for a shadow puppet performance using the layout as shown below.

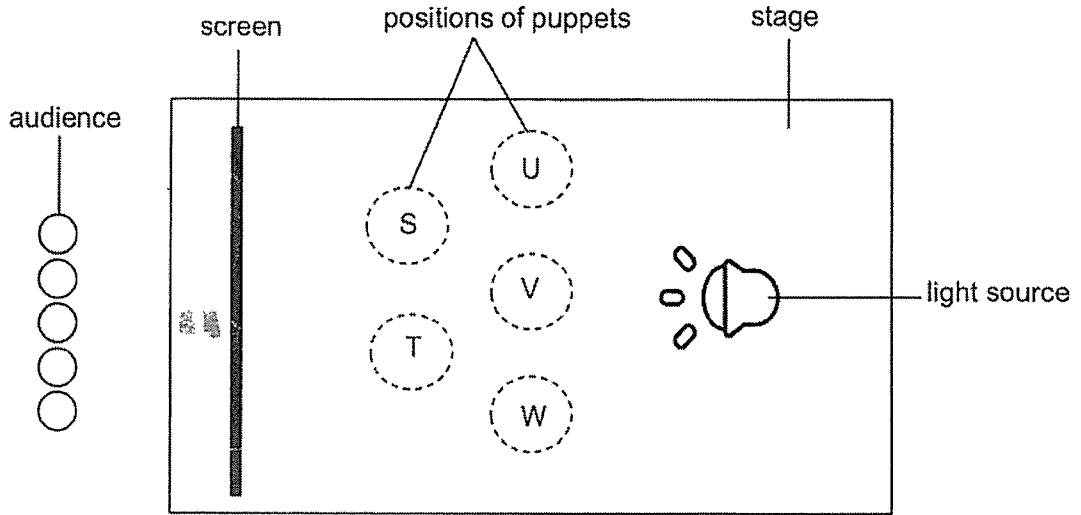

Three puppets of the same height were placed behind the screen at the start of the performance. The audience observed the following image on the screen.

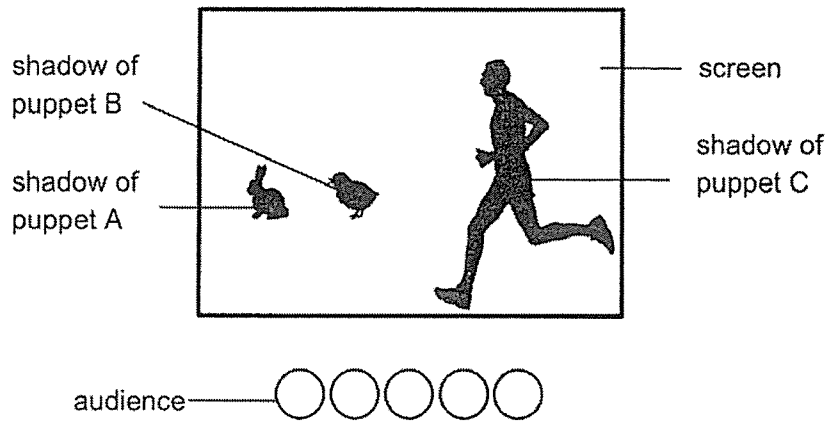

(a) Which positions should Gabriel place the puppets A, B and C to cast the shadow above? [1]

Puppet A : _____

Puppet B: _____

Puppet C: _____

Question 38 continues on the next page

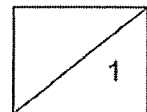

Question 38 continues on this page

- (b) Without changing the positions of the puppets, suggest what Gabriel can do to make the shadows smaller. [1]

- (c) State one property of light that cause shadows to form. [1]

- (d) What will happen to the shadow if the light source is not bright enough? [1]

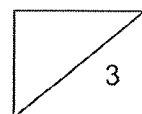

39. Ben used the set-up shown below to separate magnetic metals from non-magnetic metals. Electricity could flow through the wires coiled around the iron tube.

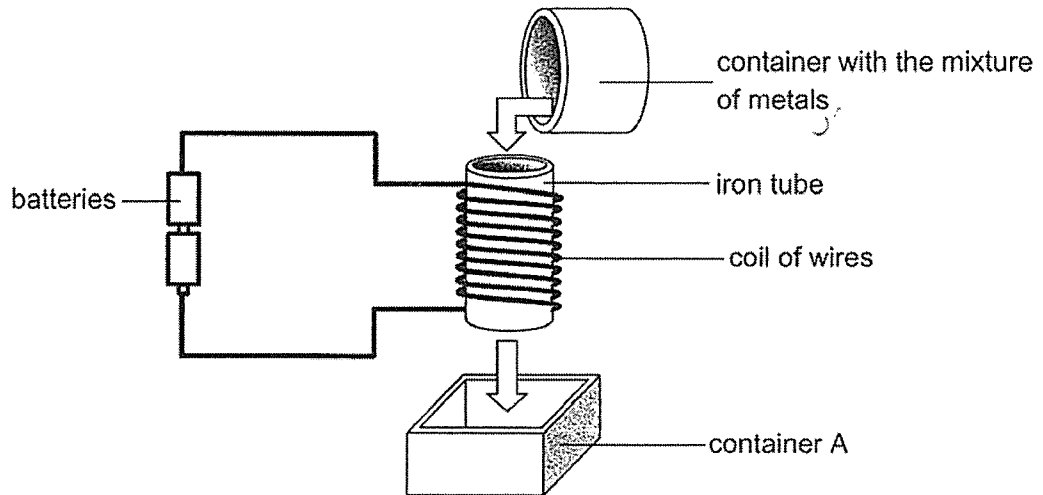

- (a) What would happen to the iron tube when electricity flowed through the wires? [1]

- (b) Which type of metal, magnetic or non-magnetic, would be collected in container A? Explain your answer. [1]

- (c) Ben found out that the set-up above is not very efficient at separating the magnetic metals from the non-magnetic metals.

Suggest two changes he can make to the set-up so that it can better separate the metals. [2]

40. Joe placed both jars Y and Z on a beam balance as shown below. The capacity of each jar is 250 cm^3 .

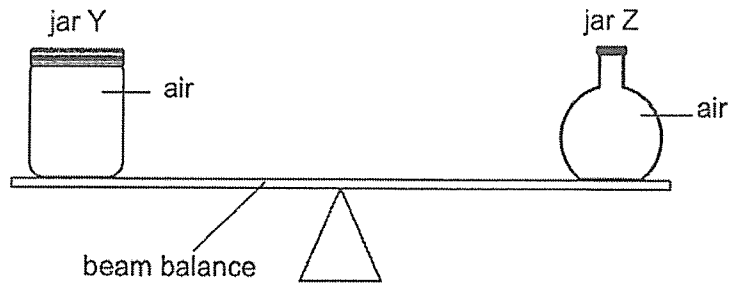

- (a) State two properties of air that are shown in the experiment above. [1]

- (b) Joe pumped another 50 cm^3 of air into jar Z. State what happens to the beam balance after more air was pumped into jar Z. [1]

- (c) Joe has 250 similar coins. Each coin has a volume of 1 cm^3 . Explain why Joe cannot put all 250 coins into the jar Y. [1]

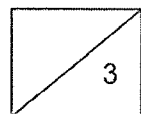

41. The diagram below shows the flushing system of a toilet bowl.

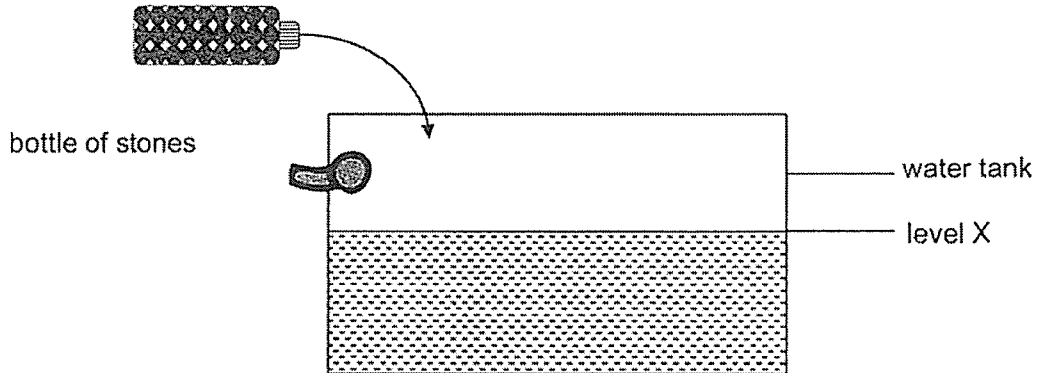

Each time after flushing, water enters and re-fills the tank. The water will stop filling the tank when it reaches level X. Andy adds a bottle filled with stones into the water tank to save water used for flushing.

- (a) Explain how does adding a bottle filled with stones affect the amount of water in the water tank? [2]

- (b) Andy observed that the water flows through pipes of different shapes and sizes in the toilet. What is the property of water that allows it to do so? [1]

END OF PAPER

B – 18

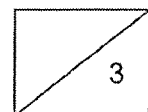

P4 EOY Science 2024 Correction Template

Name: _____ () Date: _____

Class: 4

Section A

Qn	Ans	Qn	Ans	Qn	Ans	Qn	Ans
1.	(1)	8.	(1)	15.	(1)	22.	(3)
2.	(4)	9.	(3)	16.	(3)	23.	(1)
3.	(2)	10.	(3)	17.	(1)	24.	(4)
4.	(3)	11.	(2)	18.	(1)	25.	(1)
5.	(2)	12.	(3)	19.	(4)	26.	(2)
6.	(4)	13.	(1)	20.	(4)	27.	(3)
7.	(4)	14.	(4)	21.	(1)	28.	(4)

Section B

No.	
29a	<pre> graph TD A[A] --> C[C] C[C] --> B[B] B[B] --> D[D] D[D] --> A[A] </pre>
29b	<u>B</u>
30a	<u>poor</u> / <u>bad</u>

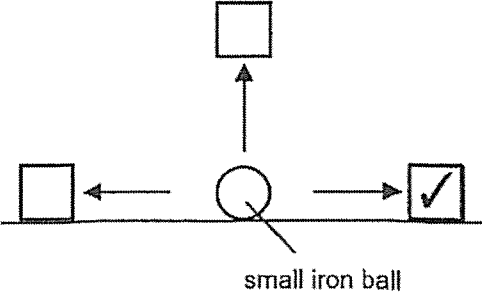
30b	<u>good</u>								
31a	<u>repel</u>								
31b	 <p style="text-align: center;">small iron ball</p>								
32a	<table border="1" style="width: 100%; border-collapse: collapse;"> <tr> <td style="width: 30px; height: 25px;"></td> <td style="padding: 2px;">It can fly.</td> </tr> <tr> <td style="width: 30px; height: 25px;"></td> <td style="padding: 2px;">It has wings.</td> </tr> <tr> <td style="width: 30px; height: 25px; text-align: center;">✓</td> <td style="padding: 2px;">It has six legs.</td> </tr> <tr> <td style="width: 30px; height: 25px; text-align: center;">✓</td> <td style="padding: 2px;">It has three body parts.</td> </tr> </table>		It can fly.		It has wings.	✓	It has six legs.	✓	It has three body parts.
	It can fly.								
	It has wings.								
✓	It has six legs.								
✓	It has three body parts.								
32bi	Both animals R and S <u>lay eggs</u> / <u>has scales</u> .								
32bi	<p>Choice: No.</p> <p>Data:</p> <p>Animal X <u>does not have scales</u> but</p> <p>animal S <u>has scales</u>.</p> <p>OR</p> <p>Animal X has <u>feathers</u> but animal S</p> <p><u>has scales</u></p>								

33a	Adult stage. Both plants have fruits / flowers .
33b	Choice : Plant T Data: Plant S has more roots than plant T. Explain: to help anchor it more firmly to the soil.
33c	This plant has weak stem.
33d	It has a straight / smooth edge.
34a	Choice: Gullet Data: There was an increase in the amount of digested food. [1] Explain: Gullet does not carry out digestion as it does not have any digestive juice .
34b	0g All the digested food is into the blood at the small intestine .
35a	floats
35b	waterproof

35c	<p>Choice: Material <u>R</u>.</p> <p>Data + Explain:</p> <p>1) Material R can <u>hold</u> the <u>greatest</u> <u>mass</u> before it broke / R is the <u>strongest</u>.</p> <p>2) Material R <u>bent</u> the <u>most</u> / R is the <u>most flexible</u>.</p>
36a	<p>The temperature of water <u>decreased</u>.</p>
36b	<p>Choice: Material <u>G</u>.</p> <p>Data:</p> <p>It has the <u>least</u> <u>decrease</u> in temperature.</p> <p>OR</p> <p>The temperature of water is the <u>highest</u> at the end of the experiment / after 30 minutes.</p> <p>Explain: It is the <u>poorest</u> conductor of heat.</p>
36c	<p><u>air</u> is a <u>poor</u> conductor of heat.</p> <p>It slows down <u>heat</u> <u>transfer</u> from <u>the body</u> to the <u>surroundings</u>.</p>
37a	<p>Choice: <u>D</u></p> <p>Data: Material D reflected the <u>most</u> amount of light.</p> <p>Explain: so they can see Sam <u>most</u> clearly.</p>

37b	To ensure that the <u>amount of light</u> detected _____ by the light sensor is <u>solely</u> _____ from the torch.
37c	The <u>darker</u> _____ the colour, the <u>lesser</u> _____ light it reflects.
38a	Puppet A: <u>S</u> _____ Puppet B: <u>T</u> _____ Puppet C: <u>W</u> _____
38b	Move light source <u>away from</u> _____ the puppets. or Move the screen <u>nearer / closer</u> _____ the puppets.
38c	Light travels in a <u>straight line</u> _____. OR Light <u>cannot</u> _____ pass through <u>opaque</u> _____ object. Only <u>some</u> _____ light can pass through <u>translucent</u> _____ object.
38d	Shadow will not be <u>clear</u> _____.
39a	It would become an <u>electromagnet</u> _____.
39b	Choice: <u>non-magnetic</u> _____ materials. Explain: The <u>non-magnetic</u> _____ materials cannot be <u>attracted</u> _____ by the magnetised iron tube.

39c	<ul style="list-style-type: none"> • Add more t turns _____ of wires to the iron tube. • Add more b batteries _____
40a	<p>Property 1: Air has m mass _____.</p> <p>Property 2: Air has no _____ definite shape / Air has v volume _____.</p>
40b	<p>The lever/beam balance will tilt down wards _____ at Jar Z.</p> <p>OR</p> <p>The lever/beam balance tilt up wards _____ at Jar Y.</p>
40c	<p>The coins have definite s shape _____ / definite v volume _____</p> <p>The coins cannot into the air spaces _____ in between the coins.</p>
41a	<p>The bottle occupies space _____.</p> <p>Lesser water _____ is needed to reach level X / to fill the tank.</p>
41b	<p>Water does not _____ have a definite shape.</p>