



Maha Bodhi School
2024 End-of-Year Examination
Primary 4
Mathematics
Booklet A

Name : _____ ()

Class : Primary 4 _____

Date : 22 October 2024

Total Duration for Booklets A and B: 1 h 45 min

INSTRUCTIONS TO CANDIDATES:

1. Do not turn over this page until you are told to do so.
2. Follow all instructions carefully.
3. Answer all questions.
4. Shade your answers in the Optical Answer Sheet (OAS) provided.

This booklet consists of 7 printed pages.

Section A (30 marks)

Questions 1 to 15 carry 2 marks each.

For each question, four options are given. One of them is the correct answer.

Make your choice (1, 2, 3 or 4) and shade your answer on the Optical Answer Sheet.

1. In which of the following does the digit 3 stand for 300?

- (1) 3809
- (2) 8039
- (3) 8903
- (4) 9308

2. Which of the following is a factor of both 18 and 42?

- (1) 6
- (2) 7
- (3) 8
- (4) 9

3. What fraction of the shapes are  ?

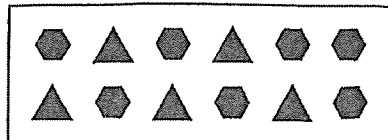

- (1) $\frac{7}{5}$
- (2) $\frac{5}{7}$
- (3) $\frac{7}{12}$
- (4) $\frac{5}{12}$

4. $\frac{5}{12} - \frac{1}{3} =$ _____

(1) $\frac{1}{12}$

(2) $\frac{2}{12}$

(3) $\frac{6}{12}$

(4) $\frac{4}{12}$

5. Which line is parallel to CD?

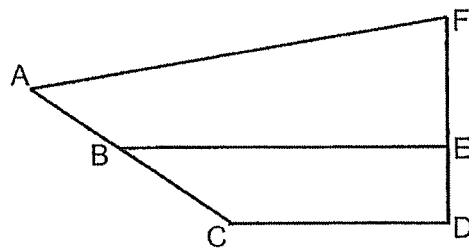

(1) AF

(2) BE

(3) AC

(4) DF

6. Express $\frac{91}{100}$ as a decimal.

(1) 0.901

(2) 0.091

(3) 0.91

(4) 9.01

7. The diagram below shows a rectangle and a square.

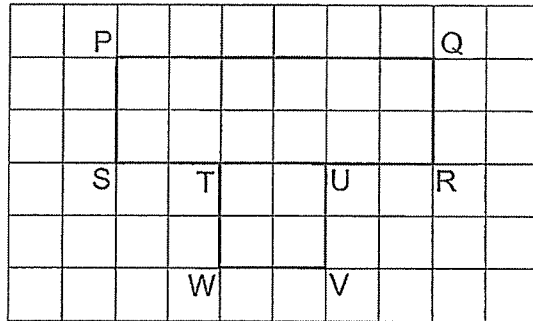

Which line is perpendicular to line TW?

- (1) PS
 - (2) QR
 - (3) UV
 - (4) SU
8. The line graph below shows the time taken by 4 boys to run a 50m race.

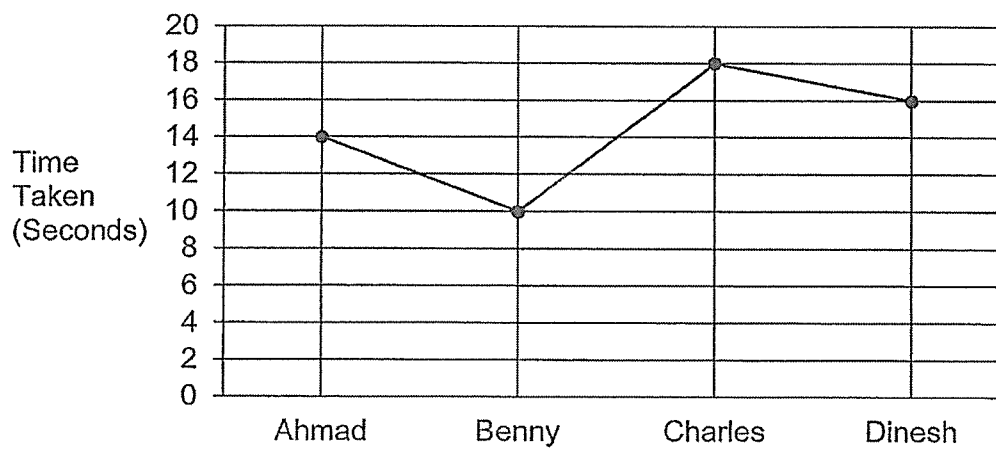

Who came in first in the race?

- (1) Ahmad
- (2) Benny
- (3) Charles
- (4) Dinesh

9. Which of the following figure is a symmetric figure?

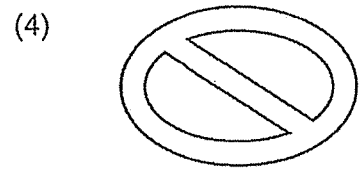
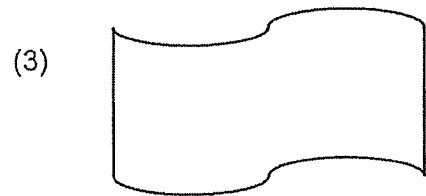
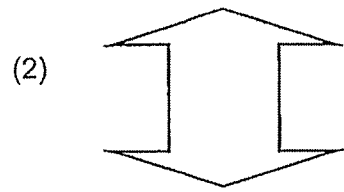
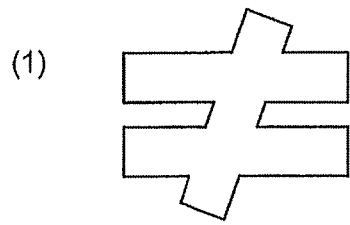

10. Bala wants to shade $\frac{2}{3}$ of the figure.

How many more triangles must he shade?

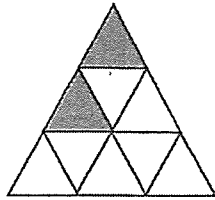

- (1) 5
(2) 2
(3) 3
(4) 4
11. The length of a pencil was 10.6 cm when rounded to 1 decimal place.
Which of the following is the greatest possible length of the pencil?
- (1) 10.53 cm
(2) 10.58 cm
(3) 10.64 cm
(4) 10.69 cm

12. Study the figure below. Find the perimeter of the figure.

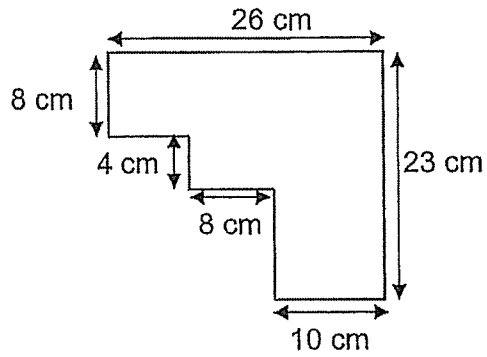

- (1) 49 cm
- (2) 79 cm
- (3) 90 cm
- (4) 98 cm

13. The diagram below shows a net of a cube. Which one of the following faces is opposite to the face marked A when folded to form a cube?

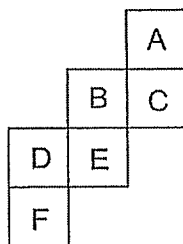

- (1) C
- (2) D
- (3) E
- (4) F

14. When rounded to the nearest ten, the price of a motorcycle remained the same.

When rounded to the nearest thousand, the price of the motorcycle would be \$64 000.

What is the price of the motorcycle?

- (1) \$63 495
- (2) \$63 790
- (3) \$64 405
- (4) \$64 690

15. The table below shows the colours that some pupils like.
A blob of ink has stained part of the data in the table.

Colours	Number of pupils
Yellow	8
Green	19
Blue	47
Red	2
Total	1

The total number of pupils is greater than 100.

What is the number of pupils who like red when the total number of pupils is the smallest possible even number?

- (1) 20
- (2) 26
- (3) 27
- (4) 28



Maha Bodhi School
2024 End-of-Year Examination
Primary 4
Mathematics
Booklet B

Name : _____ ()

Class : Primary 4 _____

Date : 22 October 2024

Total Duration for Booklets A and B: 1 h 45 min

INSTRUCTIONS TO CANDIDATES:

1. Do not turn over this page until you are told to do so.
2. Follow all instructions carefully.
3. Answer all questions.
4. Write your answers in this booklet.

Booklet	Marks Obtained	Max Marks
A		30
B		70
Total		100

Parent's signature: _____

This booklet consists of 16 printed pages.

Section B (40 marks)

Questions 16 to 35 carry 2 marks each.

Show your working clearly and write your answers in the spaces provided.

For questions which require units, give your answers in the units stated.

16. Round 59 940 to the nearest hundred.

Ans: _____

17. Arrange these numbers from the greatest to the smallest.

628 , 268 , 286 , 826

_____, _____, _____, _____
(greatest) (smallest)

18. $6072 \div 8 =$ _____

Ans: _____

B-1

/ 6

19. $\frac{3}{4} = \frac{9}{\square}$

What is the missing number in the box?

Ans: _____

20. What is the value of $\frac{4}{5} + \frac{3}{10}$?

Express your answer as a mixed number.

Ans: _____

21. Name the 2 angles that are smaller than 90° .

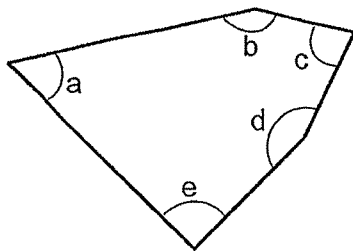

Ans: \angle _____ and \angle _____

B-2

\square / 6

22. Write the decimal represented by A.

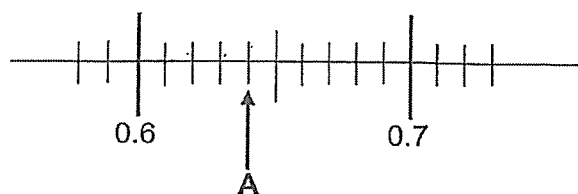

Ans: _____

23. $10.75 + 3.69 =$ _____

Ans: _____

24. Find the value of 5.63×9

Ans: _____

B-3

16

25. $\frac{5}{6} = \frac{\square}{9}$

What is the missing number in the box?

Ans: _____

26. The figure below shows a solid.

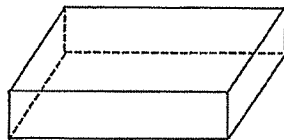

(a) Put a tick (✓) in the box for the correct net of this solid.

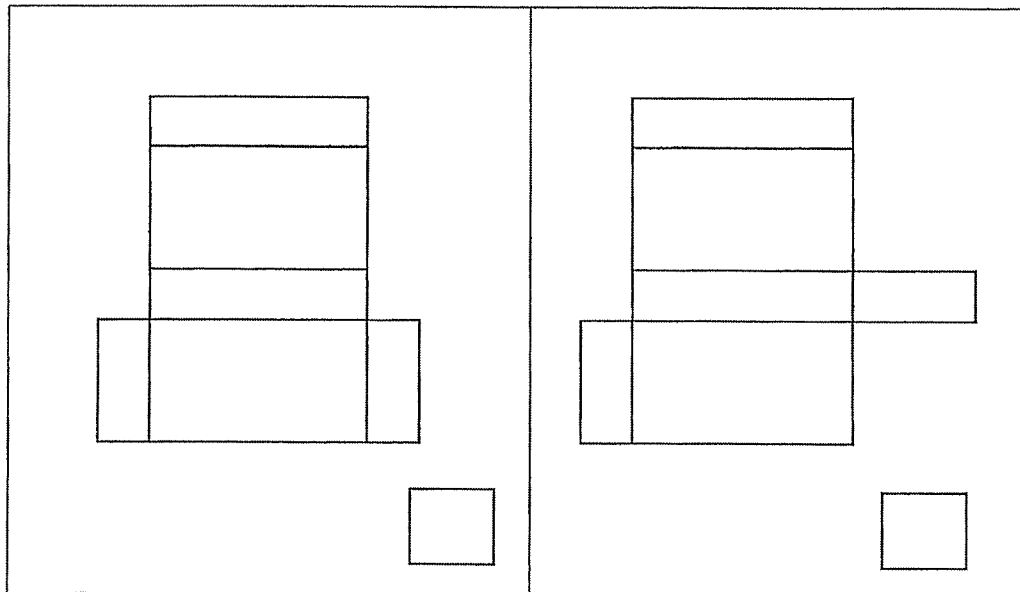

(b) Circle the solid formed by the net.

cube	cuboid
------	--------

27. Mrs Gopal had a sum of money. She spent $\frac{2}{9}$ of it to buy a sofa and $\frac{4}{9}$ of it to buy a television. She had \$1500 left. How much money did she have at first?

Ans: \$ _____

28. Arrange the following numbers from the smallest to the greatest.

1.203 , $1\frac{3}{50}$, $\frac{32}{20}$, 1.302

Ans: _____, _____, _____, _____
(smallest)

29. Janice mixed 5 l of orange juice with 2 l of carrot juice to make fruit punch. Then, she poured the fruit punch into 4 jugs. How many litres of fruit punch was in each jug?

Ans: _____ l

B-5

16

30. The bar graph below shows the number of stamps 4 boys have.

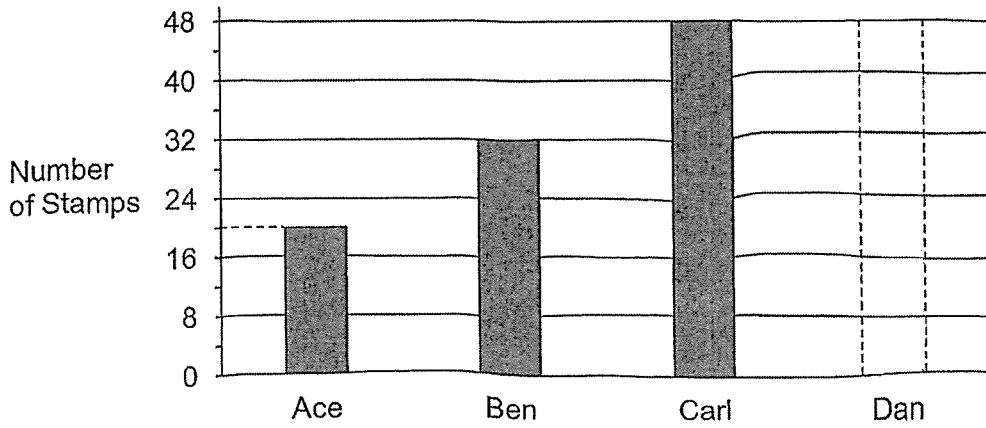

Dan has twice as many stamps as Ace.

Complete the bar graph by shading within the dotted lines to show the number of stamps Dan has.

31. 2 beakers of water are shown below.
 What is the total amount of water in the 2 beakers?
 Express your answer in litres.

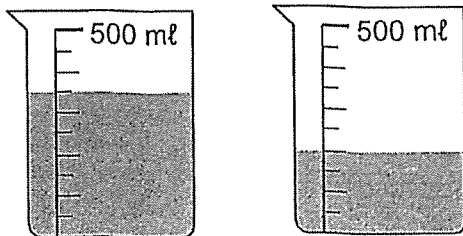

Ans: _____ ℓ

B-6

/ 4

32. Wayne arrived in school at 7.05 am.
He realised his watch was 20 minutes slower than the actual time.
He took 35 minutes to travel from his house to school.
What was the actual time he left his house?

Ans: _____

33. Figure 1 shows a pyramid. Figure 2 is not the net of the pyramid because it has an extra face. Identify this face on Figure 2 and put a cross (✕) on it.

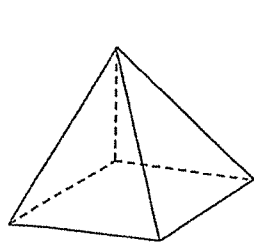

Figure 1

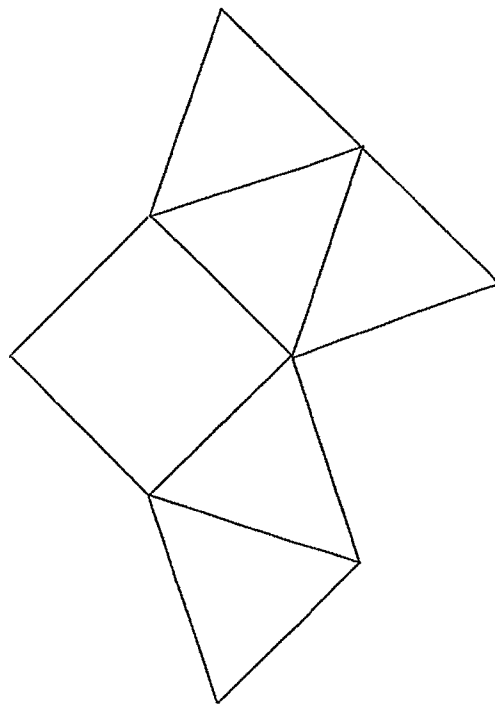
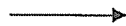
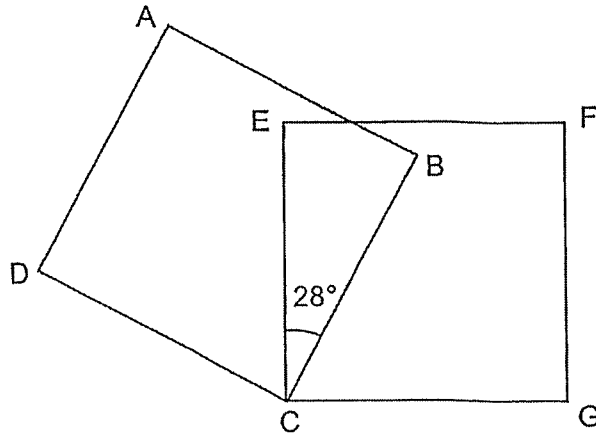

Figure 2

B-7

1/4

34. The diagram below shows two identical squares ABCD and EFGC.



What is the size of $\angle DCG$?

Ans: _____^o

35. A rectangular piece of coloured paper was folded to form the shape below.
Find the perimeter of the paper before it was folded.

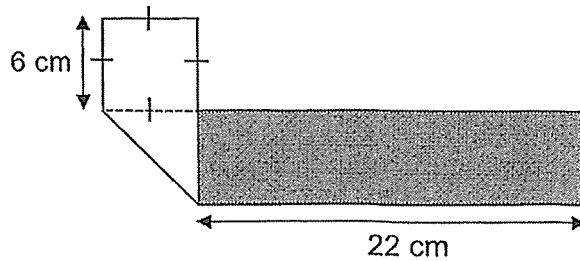

Ans: _____ cm

B-8

14

Section C (30 marks)

Questions 36 to 37 carry 3 marks each. Questions 38 to 43 carry 4 marks each.

Show your working clearly and write your answers in the spaces provided. The number of marks available is shown in brackets [] at the end of each question or part-question.

36. Ali and Bala have 274 pencils altogether.
Ali and Jane have 618 pencils altogether.
Jane has 9 times as many pencils as Bala.
How many pencils does Bala have?

Ans: _____ [3]

B-9

/ 3

37. Mdm Suhana baked some cupcakes.
The number of cupcakes is greater than 25 but fewer than 50.
If she packed the cupcakes in boxes of 4, she would have 1 cupcake left.
If she packed the cupcakes in boxes of 5, she would have no remainder.

(a) How many cupcakes did Mdm Suhana bake?

Ans: (a) _____ [2]

(b) What is the least number of additional cupcakes she should bake so that she could pack the cupcakes in boxes of 3 with no leftover?

Ans: (b) _____ [1]

B-10

/ 3

38. Aini, Kathy and Mandy formed a team to complete a 4-km race. Aini ran $\frac{3}{4}$ km.

The distance Aini ran was $\frac{2}{3}$ km shorter than the distance run by Kathy.

The rest of the race was run by Mandy.

(a) What was the distance completed by Kathy?

Ans: (a) _____ [1]

(b) What was the distance completed by Mandy?

Express your answer as a mixed number in its simplest form.

Ans: (b) _____ [3]

B-11

/ 4

39. Mrs Tan bought a watch and a bag.
The watch cost 4 times as much as the bag.
The bag cost \$89.70 less than the watch.
Mrs Tan paid the cashier two \$100 notes. How much change did she receive?

Ans: _____ [4]

B-12

/ 4

40. The pie chart below shows the type of sports that pupils in a school like.

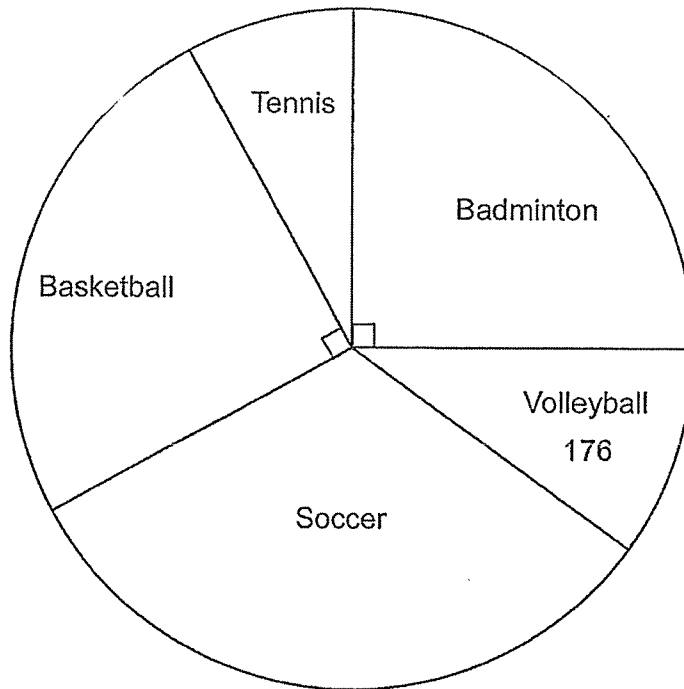

(a) $\frac{1}{8}$ of the pupils like volleyball. How many pupils are there in the school?

Ans: _____ [2]

(b) How many pupils like basketball?

Ans: _____ [2]

B-13

_____ / 4

41. The figure below is made up of a square W and three rectangles X, Y and Z.
 Rectangle Y and Rectangle Z are identical.
 Rectangle Y has a breadth of 9 cm.
 The area of Square W is 49 cm^2 . What is the area of Rectangle X?

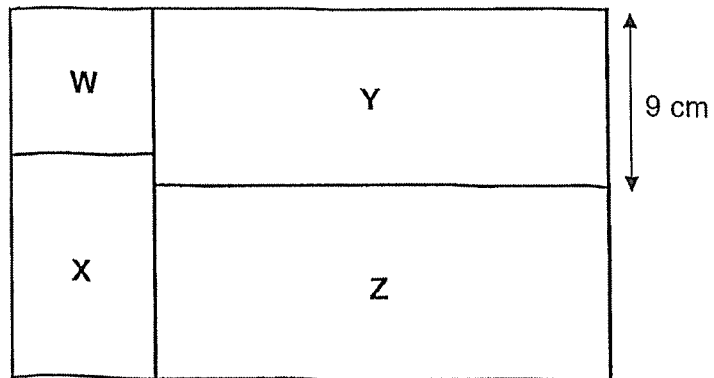

Ans: _____ [4]

B-14

/ 4

42. Beth, Joan and Sandra have ribbons of different lengths.
Joan's ribbon is 34 cm shorter than Beth's ribbon.
Sandra's ribbon is 20 cm longer than Beth's ribbon.
The 3 girls have 268 cm of ribbon altogether.
What is the length of Beth's ribbon?

Ans: _____ [4]

B-15

/ 4

43. Jack had some stickers. Ben had 470 stickers more than Jack.
Ben then gave 735 stickers to Jack.
In the end, Jack had 5 times as many stickers as Ben.
How many stickers did Ben have at first?

Ans: _____ [4]



----- The End -----

Remember to check your work!

/ 4

SCHOOL : MAHA BODHI PRIMARY SCHOOL
 LEVEL : PRIMARY 4
 SUBJECT : MATH
 TERM : 2024 SA2

Q1	Q2	Q3	Q4	Q5	Q6	Q7	Q8	Q9	Q10
4	1	3	1	2	3	4	2	2	4
Q11	Q12	Q13	Q14	Q15					
3	4	3	2	4					

Q16	59900
Q17	826, 628, 286, 268
Q18	759
Q19	12
Q20	$1\frac{1}{10}$
Q21	$<a$ and $<c$
Q22	0.64
Q23	14.44
Q24	50.67
Q25	59
Q26	<p>a)</p>

	b)cuboid										
Q27	\$4500										
Q28	$1\frac{3}{50}$, 1.203 , 1.302 , $\frac{32}{20}$										
Q29	1.75L										
Q30	<table border="1"> <caption>Number of Stamps</caption> <thead> <tr> <th>Name</th> <th>Number of Stamps</th> </tr> </thead> <tbody> <tr> <td>Ace</td> <td>20</td> </tr> <tr> <td>Ben</td> <td>32</td> </tr> <tr> <td>Carl</td> <td>48</td> </tr> <tr> <td>Dan</td> <td>44</td> </tr> </tbody> </table>	Name	Number of Stamps	Ace	20	Ben	32	Carl	48	Dan	44
Name	Number of Stamps										
Ace	20										
Ben	32										
Carl	48										
Dan	44										
Q31	550ml										
Q32	Wrong question										
Q33	<p>Figure 2</p>										
Q34	$90 - 28 = 62$ $62 + 62 + 28 = 152^\circ$										
Q35	$6+6+22+6+6+22+6+6 = 8$										
Q36	$618 - 274 = 344$ $344 \div 8 = 43$										
Q37	a)45 b)0										
Q38	a) $\frac{9}{12} + \frac{8}{12} = 1\frac{5}{12}$ b) $1\frac{5}{12} + \frac{9}{12} = 2\frac{2}{12} = 2\frac{1}{6}$ $4 - 2\frac{1}{6} = 1\frac{5}{6}$ km										

Q39	$100 \times 2 = 200$ $89.70 \div 3 = 29.90$ $29.90 \times 5 = 149.50$ $200 - 149.50 = \$50.50$
Q40	a) $176 \times 8 = 1408$ pupils b) $1408 \div 4 = 352$ pupils
Q41)	$49 = 7 \times 7$ $9 - 7 = 2$ $9 + 2 = 11$ $11 \times 7 = 77\text{cm}^2$
Q42)	$268 - 20 - 34 - 34 = 180$ $180 \div 3 = 60$ $60 + 34 = 94$
Q43)	$735 \times 2 = 1470$ $1470 - 470 = 1000$ $1000 \div 4 = 250$ $250 + 735 = 985$ stickers

