

**RAFFLES GIRLS' PRIMARY SCHOOL
WEIGHTED ASSESSMENT 2
PRIMARY SIX
2023**

SCIENCE

Name: _____ ()

Date : 9 May 2023

Class: P6 _____

Total Time: 30min

INSTRUCTIONS

1. Write your name, class and index number in the spaces provided above.
2. Do not turn over this page until you are told to do so.
3. Follow all instructions carefully.
4. Answer all questions.
5. For Question 1- 20, use 2B pencil to shade your answers on the Optical Answer Sheet (OAS).

Your score out of 40	
Parent's signature	

1. Which one of the following statements is true?
 - (1) Only plants depend on the sun for energy.
 - (2) Plants make food using water, light energy and oxygen.
 - (3) Meat-eaters such as sharks do not need plants for energy.
 - (4) Living things depend directly or indirectly on the sun for energy

2. Raju has two identical fish tanks filled with same amount of water. He placed the fish tanks in clear plastic and opaque boxes of identical sizes respectively as shown in the diagram.

He left the boxes near an open window and fed the fishes daily with same amount of food.

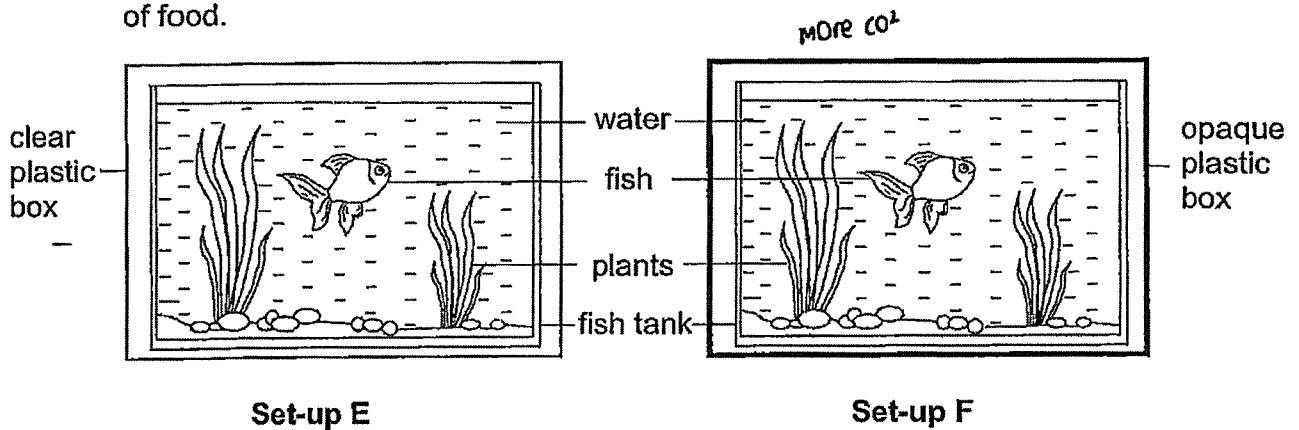

After a few days, Raju noticed that the fish in set-up E survived while the fish in set-up F died.

Based on the information above, which of the following statement(s) show(s) the correct observation after a few days?

- A The plants in set-up E can photosynthesise.
- B There is more oxygen in set-up F than set-up E.
- C There is more carbon dioxide in set-up E than set-up F.

- (1) A only
- (2) C only
- (3) A and B only
- (4) B and C only

3. Aminah left a plant in a dark cupboard for three days to de-starch it.

She then wrapped three similar-sized leaves, A, B and C, in identical clear plastic bags. The plastic bags contained same amount of substances of different types as shown in the diagram. Then, she placed the plant in the garden for twenty-four hours.

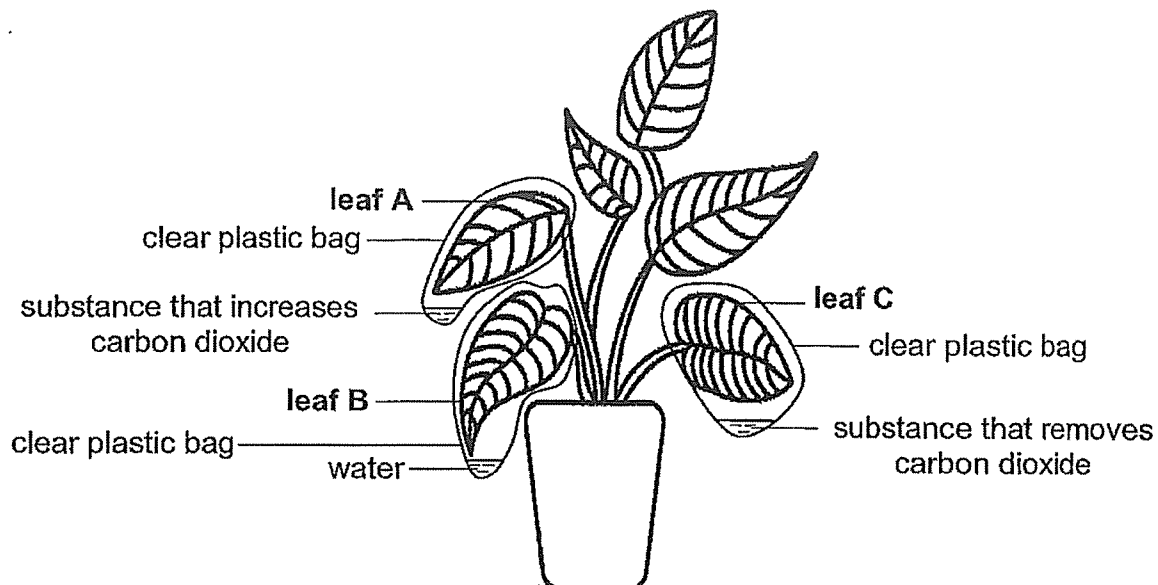

After twenty-four hours, Aminah did a starch test using iodine solution on the three leaves, A, B and C. Iodine turns blue-black in the presence of starch.

Which of the following shows the colour of the iodine solution on each leaf?

	Leaf A	Leaf B	Leaf C
(1)	Yellowish-brown	Yellowish-brown	Dark blue
(2)	Yellowish-brown	Dark blue	Yellowish-brown
(3)	Dark blue	Yellowish-brown	Dark blue
(4)	Dark blue	Dark blue	Yellowish-brown

4. Siti wanted to find out if the colour of light would affect the rate of photosynthesis. She placed an equal amount of water plants under an inverted funnel in four identical set-ups.

She then placed each set-up in front of different coloured lamps in a dark room for twenty-four hours as shown in the diagram.

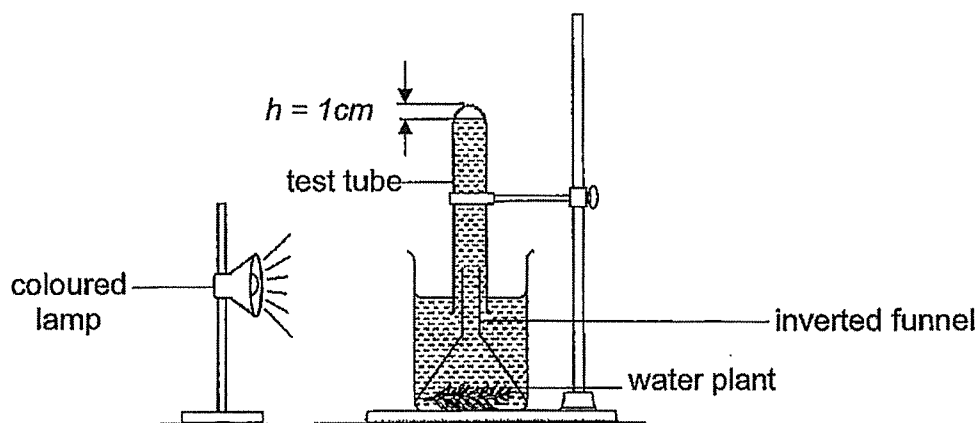

At the start of the experiment, Siti measured the height of the air column, h , above the water in the test tube to be 1 cm.

After twenty-four hours, Siti measured the height, h , as shown in the diagram and recorded the result as shown in the table below.

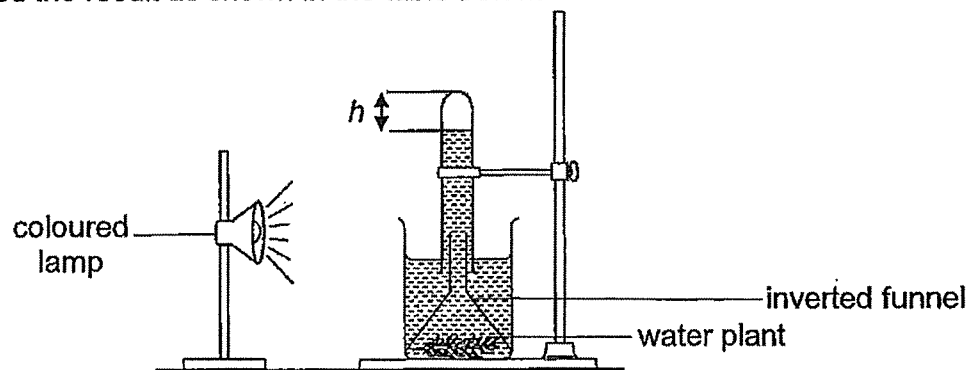

Colour of light	h (cm)
red	3.5
blue	3
green	1
white	5

Based on the information above, which one of the following statements is correct?

- (1) The colour of the light does not affect rate of photosynthesis.
- (2) The plant produced the least amount of oxygen under green light.
- (3) The plant produced the most amount of sugar under white light.
- (4) The plant exposed to red light has the fastest rate of photosynthesis.

5. Lily placed her paper shopping bag inside a plastic bag after she noticed that it was raining outside the mall.

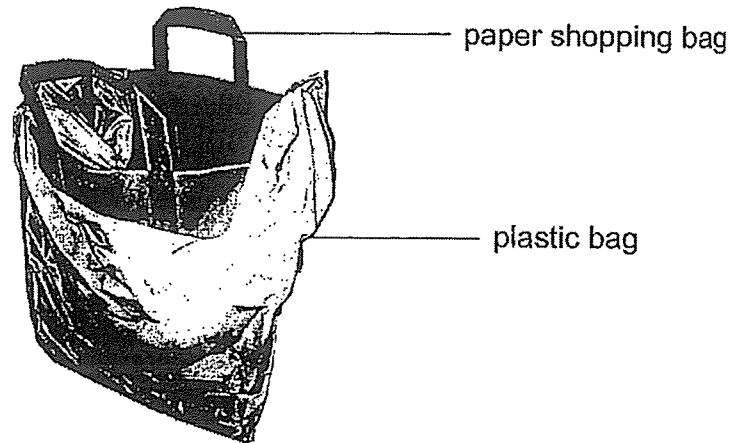

Which property of the plastic bag would protect the items in the paper bag from the rain when Lily stepped out of the mall?

- (1) Flexibility
- (2) Waterproof
- (3) Transparency
- (4) Ability to float

6. The table shows the properties of materials P, Q, R and S.
A tick (✓) indicates the presence of the property.

Material	Property		
	Flexible	Waterproof	Strong
P	✓	✓	
Q		✓	✓
R			✓
S	✓		✓

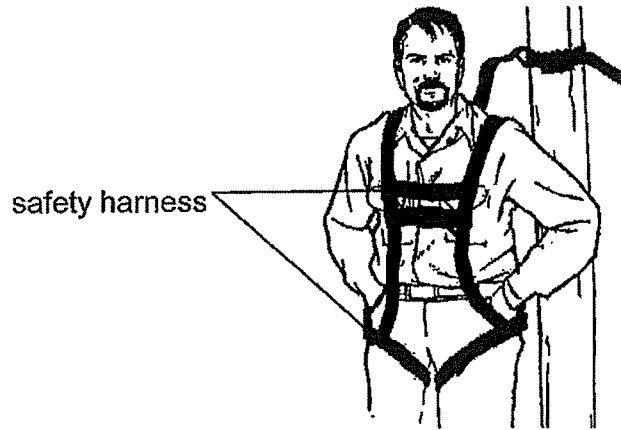

Which material, P, Q, R or S, would you use to make a safety harness as shown in the diagram?

- (1) P
- (2) Q
- (3) R
- (4) S

7. Peter made four temporary magnets using the stroke method. He stroked four identical steel nails in the direction shown in the diagram for fifty times for each nail.

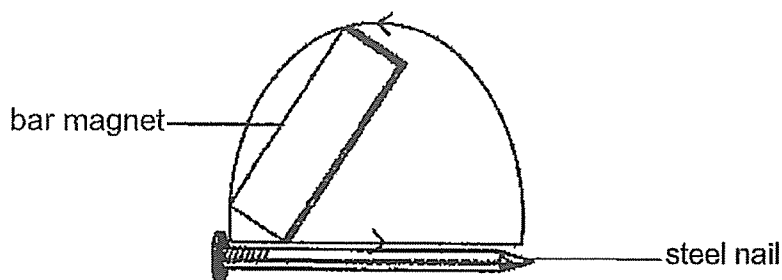

Peter then treated each magnetised steel as shown in the table.

Magnetised steel nail	Treatment
H	Dropped on the floor a hundred times
J	Put in boiling water for ten minutes
K	Stroked in the opposite direction a hundred times
L	Stroked in the same direction more than fifty times

Each magnetised steel nail is then placed into a container of paper clips.

Which magnetised steel nail will be able to attract the greatest number of clips?

- (1) H
- (2) J
- (3) K
- (4) L

8. Raju prepared an experimental set-up using magnets and a wooden block as shown.

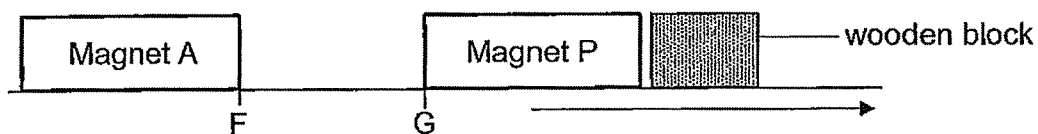

Magnet A was placed at position F. When Raju placed magnet P at position G, he observed that magnet P moved further away from magnet A and pushed the wooden block as shown by the arrow. He measured and recorded the distance travelled by the wooden block in the table.

He repeated the experiment by replacing magnet P with magnets Q, R and S respectively.

Magnet	Distance travelled by the wooden block (cm)
P	12
Q	6
R	15
S	3

Based on the information above, which of the statements below is true?

- (1) Magnet R exerted the greatest magnetic force of repulsion.
 - (2) Magnet S exerted the greatest magnetic force of attraction.
 - (3) Magnet Q has a stronger magnetic strength than magnet P.
 - (4) Magnet R has a weaker magnetic strength than magnet P.
9. Joyce had four identical rods, W, X, Y and Z. She placed two ends of the rods facing each other and recorded her observations of their interactions in the table.

Rod brought together	Observation
W and X	W moved towards
W and Y	No interaction
X and Z	X and Z moved away from each other
Y and Z	No interaction

Which of the following identifies the objects correctly?

	Rod W	Rod X	Rod Y	Rod Z
(1)	Iron rod	Magnet	Plastic rod	Magnet
(2)	Magnet	Iron rod	Magnet	Iron rod
(3)	Magnet	Plastic rod	Magnet	Iron rod
(4)	Plastic rod	Magnet	Iron rod	Magnet

10. Ball A started rolling from point Y in the direction shown. When the rolling ball B hit on ball A, it started to roll faster in the direction shown. Ball A continued to roll until it stopped at point Z as shown.

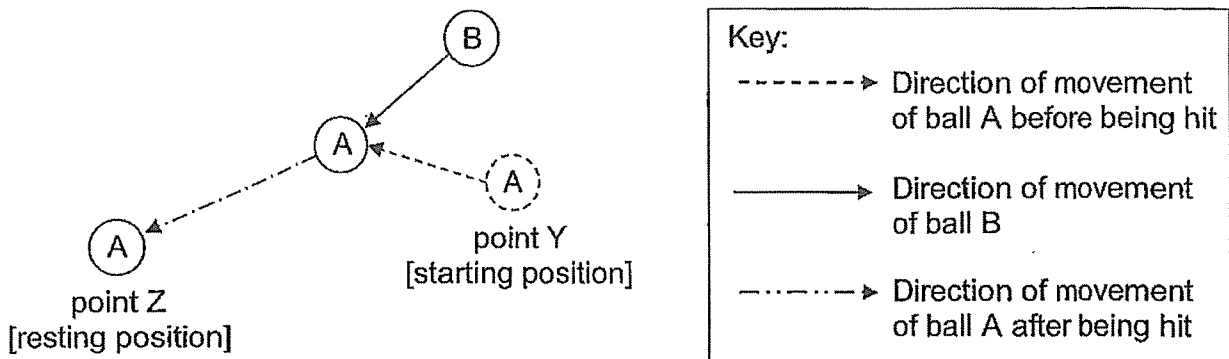

Based on the information above, what is/are the effect(s) of force observed when ball B hits ball A?

A force can _____.

- A stop a moving object
- B increase speed of a moving object
- C decrease speed of a moving object
- D change direction of a moving object

- (1) A only
- (2) B only
- (3) A and C only
- (4) B and D only

11. James attached a coil of spring in a tube as shown in diagram 1. Next, he placed a ball on a spring in a tube as shown in diagram 2.

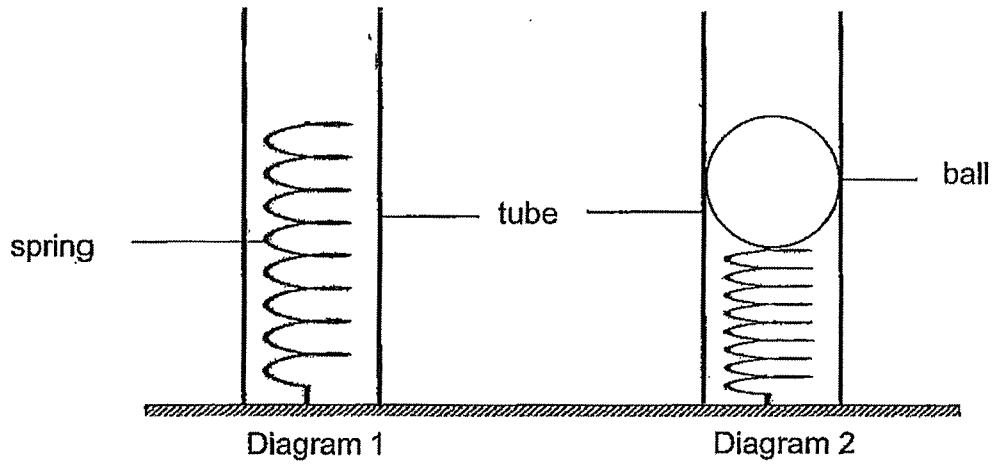

Which of the following statement(s) is/are correct about the ball in diagram 2?

- A There is no force acting on the ball.
- B The spring exerts a force on the ball.
- C There is gravitational force acting on the ball.

- (1) A only
- (2) B only
- (3) C only
- (4) B and C only

12. Ben placed magnet P at point Y and a paper clip at a distance away from the magnet as shown.

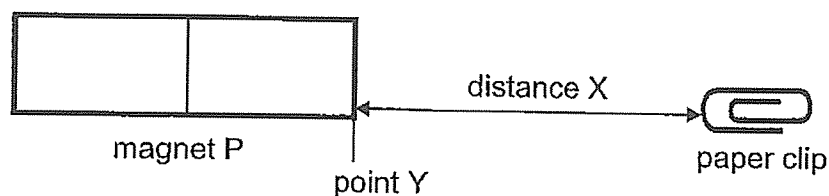

Ben moved the paper clip slowly towards magnet P. He measured distance X, the greatest distance at which the magnet could still attract the paper clip.

He repeated the experiment with three other magnets, Q, R and S, and recorded his results in the table as shown.

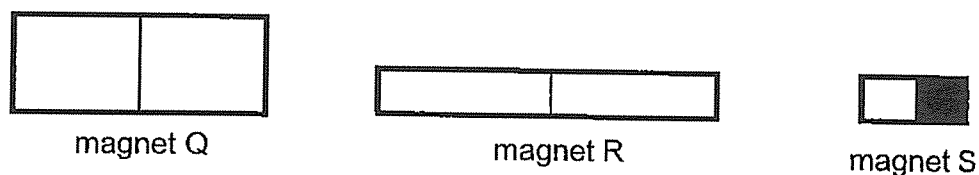

Magnet	P	Q	R	S
Distance X (cm)	9	4	1	6

Based on Ben's results, which of the following statements are true?

- A Magnet S exerts the least magnetic force.
- B Magnet P has the greatest magnetic force of attraction.
- C The size of a magnet does not affect its magnetic force.
- D Only magnet Q can attract a paper clip placed 4cm away.

- (1) A and C only
- (2) A and D only
- (3) B and C only
- (4) B, C, and D only

13. A hook with a rubber suction pad was placed onto a wall as shown.

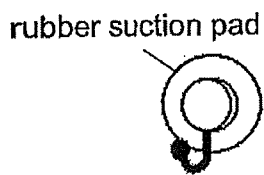

hook (front view)

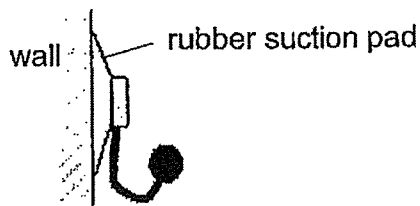

hook (side view)

Ling hung a towel on the hook. The graph shows the amount of friction and weight acting on the hook.

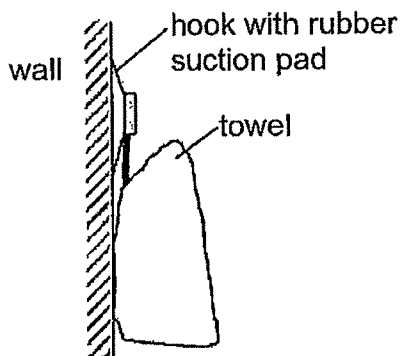

Ling hung one towel at a time on the hook. When the fifth towel was hung, both the towels and the hook slid down to the floor.

Which graph correctly shows the amounts of different types of forces when the fifth towel was hung?

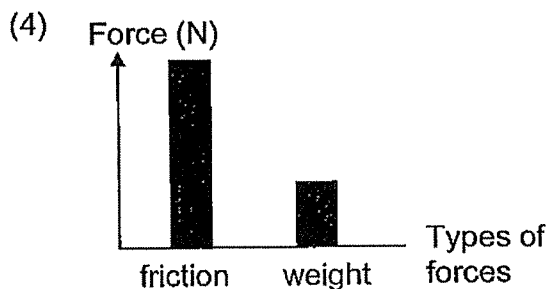
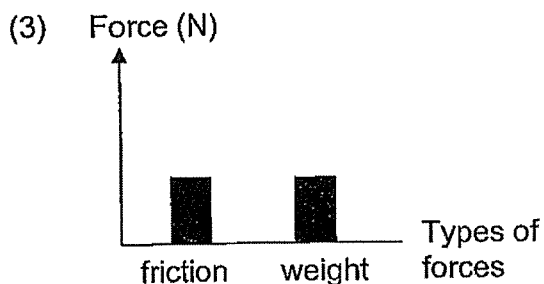
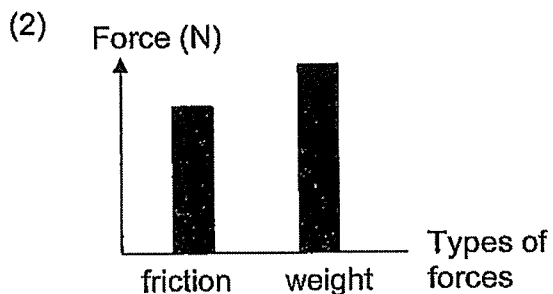
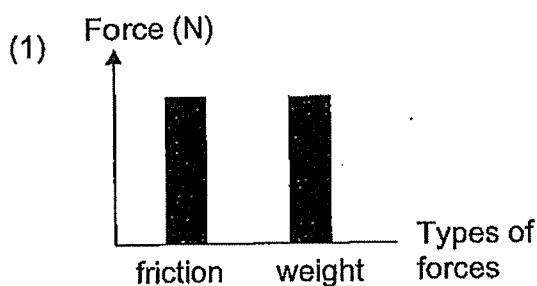

14. Which of the following is correct about heat and temperature?
- (1) Heat travels from a colder object to a hotter object.
 - (2) Temperature can be accurately measured by touch.
 - (3) All objects of the same temperature have the same amount of heat energy.
 - (4) An increase in the temperature of an object is caused by the object gaining heat.
15. Tom's house has two similar rooms with windows made of different materials as shown in the diagram.



He measured the temperature of the air in rooms P and Q for one hour and recorded the results in the table.

Time (h)	Temperature of air in room P (°C)	Temperature of air in room Q (°C)
0700	27.0	27.0
0715	27.8	27.4
0730	28.3	27.9
0745	28.7	28.0
0800	30.0	28.5

Which of the following statements is correct?

- (1) The air in room Q will cool down faster at night.
- (2) The air in room P will lose heat slower compared to the air in room Q.
- (3) The temperature of air in room P will be lower than the temperature of room Q from 0800 h to 1300 h.
- (4) The window in room P is made of a better conductor of heat compared to the window in room Q.

16. The diagram shows a toy which consists of a liquid in a glass container with two chambers and a tube.

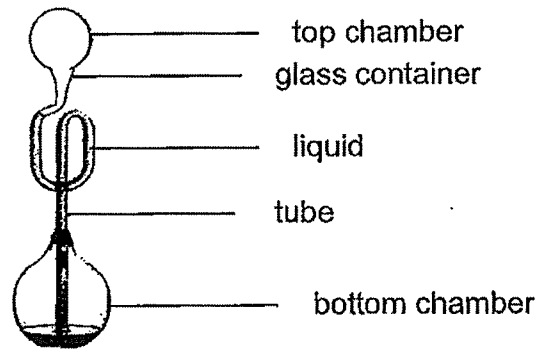

Which of the following describes and explains what happens to the liquid in the bottom chamber when a person wraps the bottom chamber of the toy with his hand.

	Description	Explanation
(1)	The liquid in the glass moves down the tube	The hand gains heat from the liquid through the glass and expands
(2)	The liquid in the glass moves down the tube	The liquid loses heat to the hand through the glass and contracts
(3)	The liquid in the glass moves up the tube	The liquid gains heat from the hand through the glass and expands
(4)	The liquid in the glass moves up the tube	The hand loses heat to the liquid through the glass and contracts

17. Which of the following activity/activities require(s) energy?

- A A person sleeping
- B Digestion of food
- C Tree taking in water from its roots

- (1) B only
- (2) A and C only
- (3) B and C only
- (4) A, B and C

18. The diagram shows a roller coaster car on the track.

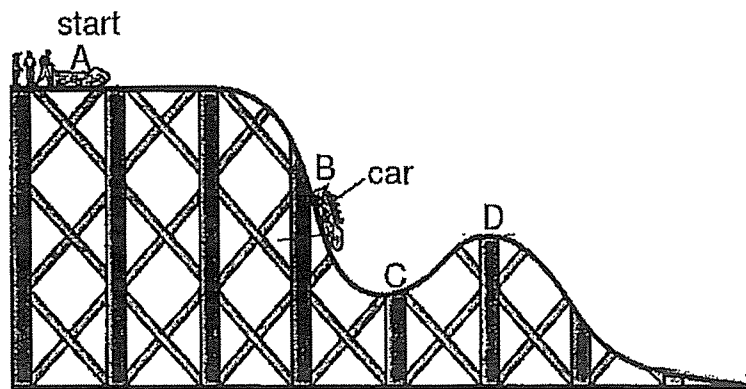

Which of the following is/are correct about the potential and kinetic energy of the roller coaster car at points A, B, C and D?

- A There is more potential energy at A than D.
- B There is more kinetic energy at point B than D.
- C Potential energy is converted to kinetic energy from C to D.
- D Kinetic energy is converted to potential energy from B to C.

- (1) A only
- (2) A and B only
- (3) B and C only
- (4) C and D only

19. The diagram shows a toy with a spring that is compressed and released at A. The toy will move in the direction shown by the arrows in the diagram.

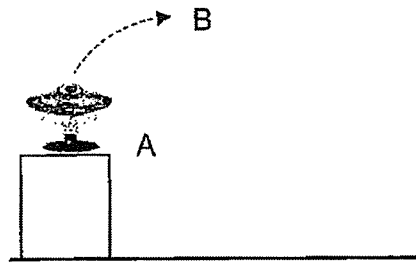

Which of the following graphs represent the correct type of energy and its amount when the toy is released at A until it reaches B?

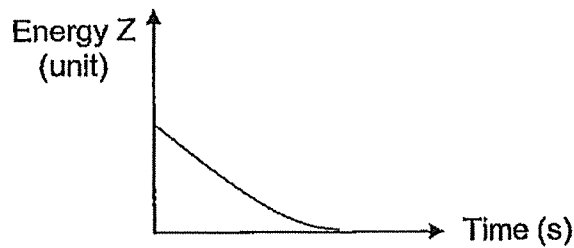
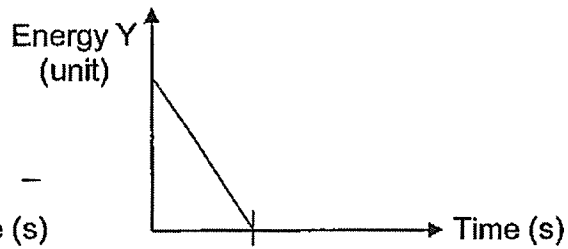
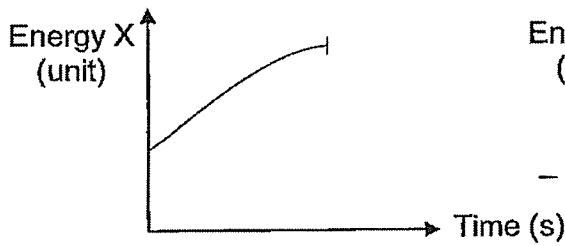

	Elastic potential energy of the spring in the toy	Gravitational potential energy of the toy	Kinetic energy of the jumping toy
(1)	X	Y	Z
(2)	Y	Z	X
(3)	Y	X	Z
(4)	Z X	X Z	Y

- 20 The diagram shows a water wheel which was used in the olden days to generate electricity.

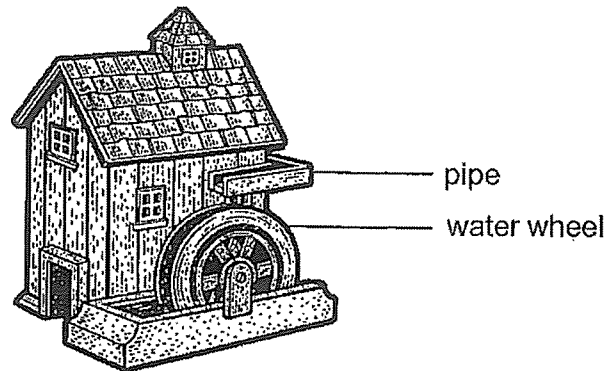

Water flows through the pipe onto the water wheel as shown in the diagram. This causes the water wheel to turn.

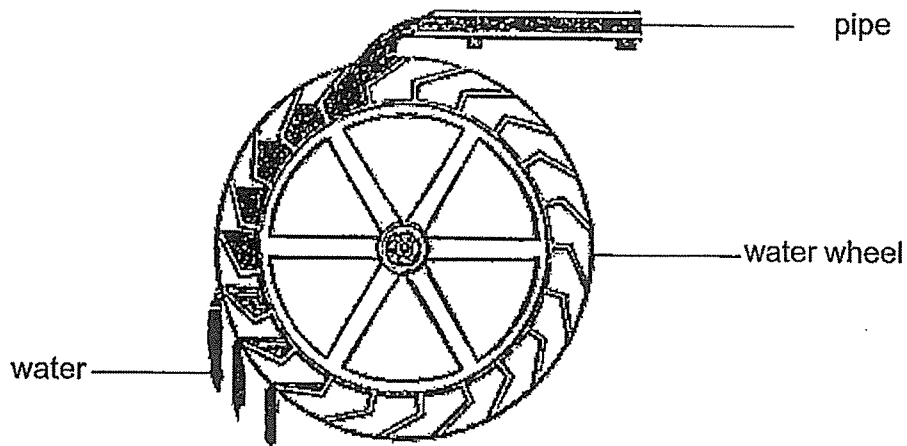

Based on the information above, which of the following statements is/are correct?

- A More electricity can be generated by using a bigger water wheel.
- B Increasing the distance between the water wheel and the pipe causes the wheel to turn faster.
- C Potential energy of the water is converted into electrical energy of the water wheel.
- D The amount of potential energy of the water in the pipe depends on the diameter of the pipe.

- (1) B only
- (2) B and D only
- (3) A and D only
- (4) A, C and D only

End of Paper

SCHOOL : RAFFLES GIRLS' PRIMARY SCHOOL
LEVEL : PRIMARY 6
SUBJECT : SCIENCE
TERM : WA2 2023

Q 1	Q2	Q3	Q4	Q5	Q6	Q7	Q8	Q9	Q10
4	1	4	3	2	4	4	1	1	4
Q 11	Q12	Q13	Q14	Q15	Q16	Q17	Q18	Q19	Q20
4	3	2	4	4	3	4	2	3	2

