



NANYANG PRIMARY SCHOOL

**2023
PRIMARY 5
END-OF-YEAR EXAMINATION**

**SCIENCE
(BOOKLET A)**

Total Time for Booklets A and B: 1 h 45 min

INSTRUCTIONS TO CANDIDATES

- 1. Write your name and index number in the space provided.**
- 2. Do not open this booklet until you are told to do so.**
- 3. Follow all instructions carefully.**
- 4. Answer all questions.**
- 5. For each question from 1 to 28, four options are given.
Indicate your choice in this booklet.
Shade the correct oval (1, 2, 3 or 4) on the Optical Answer Sheet provided.**

Name: _____ ()

Class: Primary 5 ()

Booklet A consists of 15 printed pages including this cover page.

Section A: Multiple Choice Questions [56 marks]

1. The diagram below shows the female reproductive part of a flower soon after pollination.

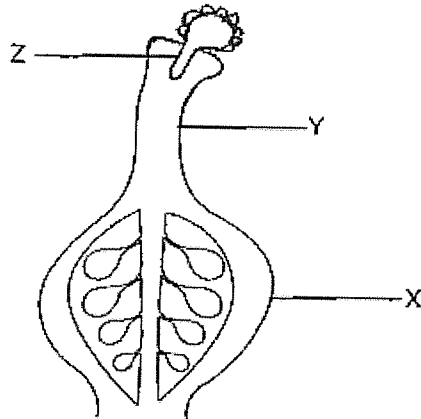

Which of the following shows the parts labelled X, Y and Z correctly?

	X	Y	Z
(1)	ovary	style	pollen tube
(2)	pollen tube	ovary	style
(3)	ovary	pollen tube	style
(4)	style	ovary	pollen tube

2. The diagram below shows the female reproductive system.

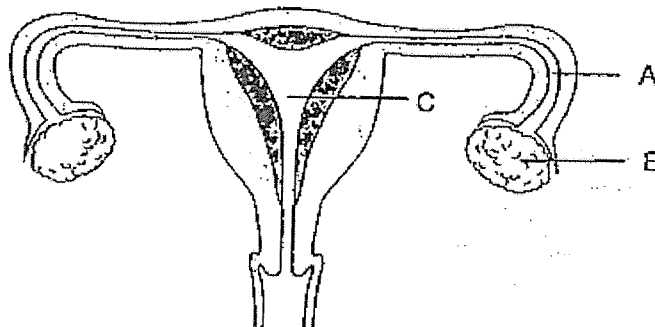

Which of the following is correct?

	where eggs are produced	where baby develops
(1)	A	B
(2)	A	C
(3)	B	A
(4)	B	C

3. The diagram below shows a plant with its parts labelled A, B, C and D.

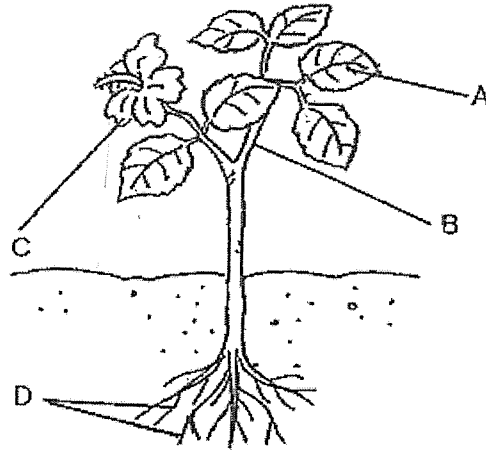

Which part(s) of the plant contain(s) the water-carrying tubes?

- (1) A only
(2) D only
(3) B and C only
(4) A, B, C and D
4. Four students made statements on the function of the human circulatory system below.
- Lukas: Transports only water and carbon dioxide all over the body.
Meiling: Transports oxygen in the blood from the heart to the other parts of the body.
Nathan: Works with the digestive system to transport digested food to other parts of the body.
Osman: Works with the respiratory system to remove carbon dioxide and waste materials from the body.

Which students had correctly described the functions of the human circulatory system?

- (1) Lukas and Meiling only
(2) Meiling and Nathan only
(3) Lukas, Nathan and Osman only
(4) Meiling, Nathan and Osman only

5. The diagram below shows a typical plant cell taken from the leaf of a plant.

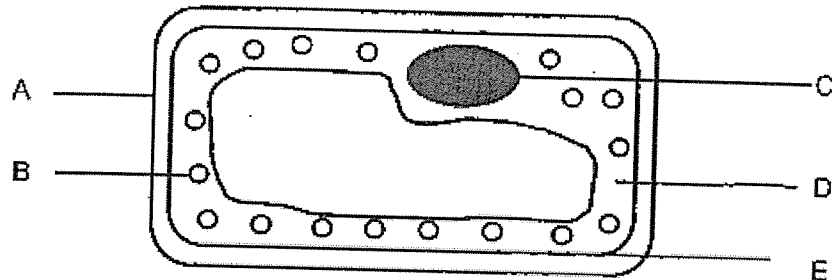

Which parts of the leaf cell are also found in the human cheek cell?

- (1) A and C only
 (2) A, B, and D only
 (3) C, D and E only
 (4) B C, D and E
6. How is the life cycle of a frog similar to a cockroach?
- (1) Both lay eggs in water.
 (2) Both have three stages in their life cycles.
 (3) The young of both animals is called a nymph.
 (4) The young of both animals resembles the adult.

7. Three students made some statements about the life cycle of plants.

Pete: Flowering plants reproduce by seeds.
 Suzy: The shoot appears first followed by the roots.
 Cath: A seed can germinate when there is only sunlight and air.

Which student(s) was/were correct?

- (1) Pete only
 (2) Cath only
 (3) Pete and Suzy only
 (4) Suzy and Cath
8. Which are the two body systems that oxygen in the air will first pass through before it can be used by the cells in our body?
- (1) Digestive and circulatory systems
 (2) Respiratory and digestive systems
 (3) Respiratory and circulatory systems
 (4) Respiratory and reproductive systems

9. Look at the following statements about the mouth and the small intestine below.

- A The mouth and the small intestine absorb water.
- B The mouth and the small intestine contain digestive juice.
- C The mouth and the small intestine absorb digested food into the bloodstream

Which one of the following statement(s) is/are correct?

- (1) B only
- (2) C only
- (3) A and B only
- (4) A and C only

10. The diagram below represents the water cycle.

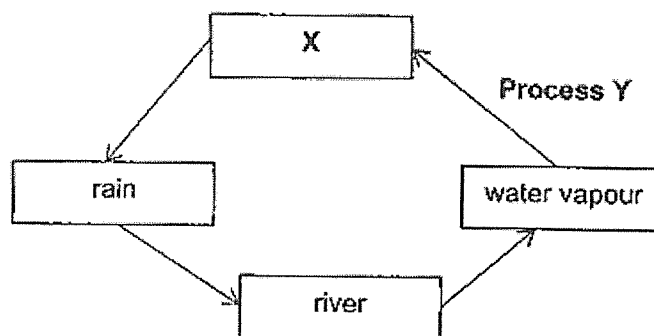

Which one of the following correctly shows the correct states of water at X and process Y in the water cycle above?

	State of water at X	Process Y
(1)	liquid	evaporation
(2)	gas	condensation
(3)	liquid	condensation
(4)	gas	evaporation

11. The table below shows substances A, B and C in different states at different temperatures.

Substance	State of substance at		
	28°C	55°C	90°C
A	solid	solid	solid
B	liquid	liquid	gas
C	solid	solid	liquid

Which one of the following statements about substances A, B and C is correct?

- (1) The boiling point of B is at 50°C.
- (2) Substance C has lowest melting point.
- (3) Substance B has a lower boiling point than substance A.
- (4) Substance A has a lower freezing point than substance C.

12. Adam took a beaker of water at room temperature and added four identical ice cubes into it. After 5 minutes, he placed the beaker onto a hot plate and heated the beaker of water for another 10 minutes until it boiled, as shown in the diagram below.

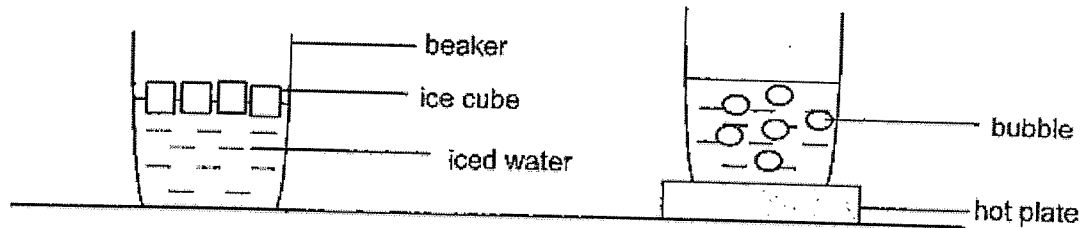

Which one of the following graphs below shows the changes in the temperature of water in the beaker correctly?

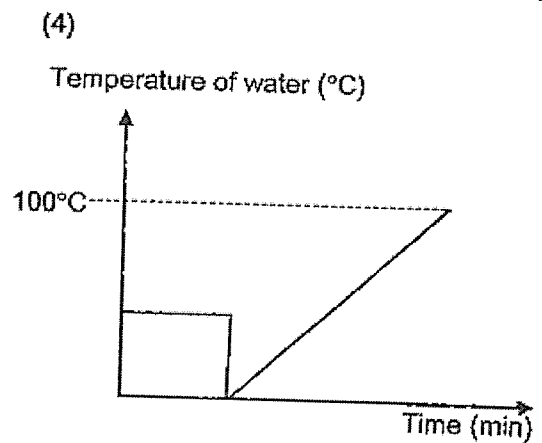
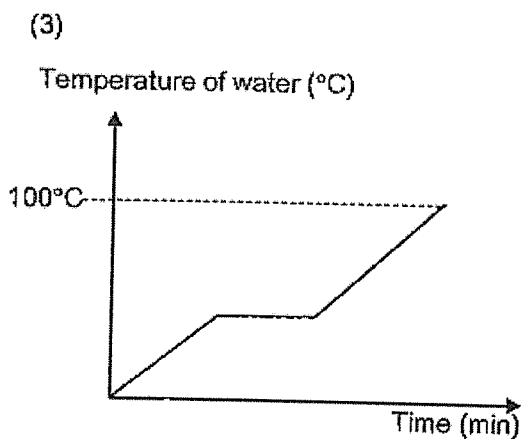
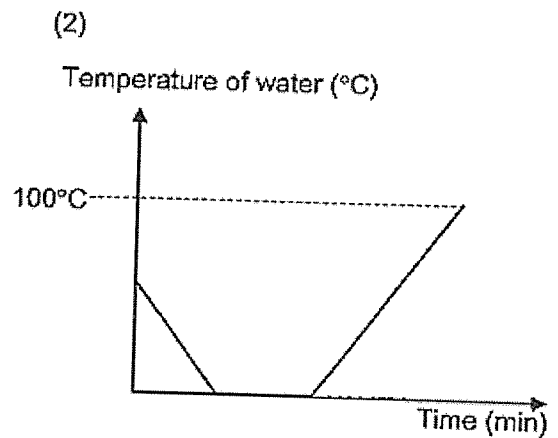
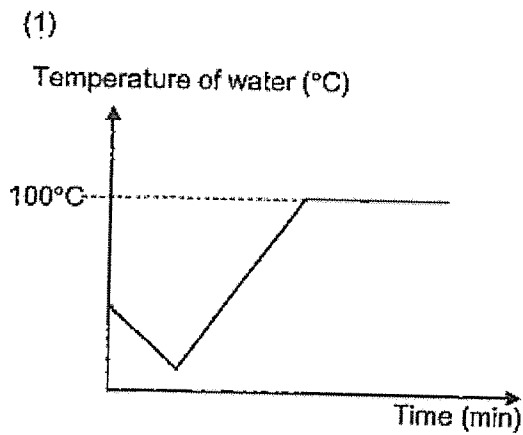

13. Justin set up a terrarium as shown in the diagram below. He observed the terrarium for one week.

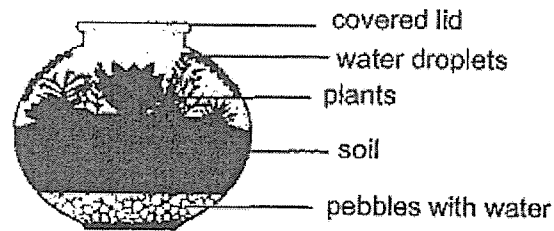

Based on his observation, Justin made some statements.

- A The water from the soil gains heat and evaporates to form water vapour.
 B When the temperature in the terrarium increases, the rate of evaporation increases.
 C When the temperature outside the terrarium decreases, the rate of condensation in the terrarium decreases.

Which one of the following statement(s) is/are wrong?

- (1) C only
 (2) A and B only
 (3) B and C only
 (4) A, B and C only
14. Sharif observed the water from four ponds located around his neighbourhood for a month. He collected the data and recorded his findings in the table below.

Pond	Quality of pond water	Presence of factory discharging waste into water	Presence of oil
A	clear	no	no
B	clear	yes	no
C	muddy	no	yes
D	muddy	yes	yes

Which of the pond water are most likely polluted?

- (1) A and C only
 (2) B and D only
 (3) B, C and D only
 (4) A, B, C and D
15. Nigel's father had just received his utility bill for the month of February. He realised that the amount of water usage had increased over the month.

Which one of the following would help Nigel and his family to reduce the water bill?

- (1) Turn off the water heater when not in use.
 (2) Wash the clothes in the washing machine when it is half-loaded.
 (3) Use the water hose to wash the car instead of using a pail of water.
 (4) Turn off the water tap when applying soap to the body and take shorter showers.

16. Jessie set up 4 circuits, A, B, C and D, with identical bulbs and working batteries as shown below.

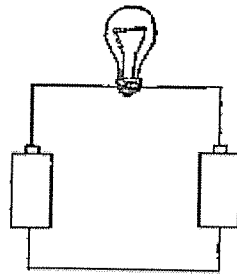

Circuit A

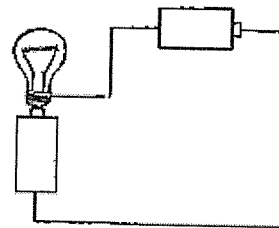

Circuit B

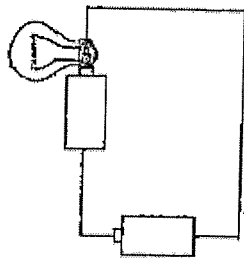

Circuit C

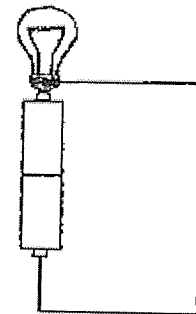

Circuit D

Which of the following circuit(s) would light up?

- (1) B only
- (2) D only
- (3) A and B only
- (4) C and D only

17. Study the circuit diagram below.

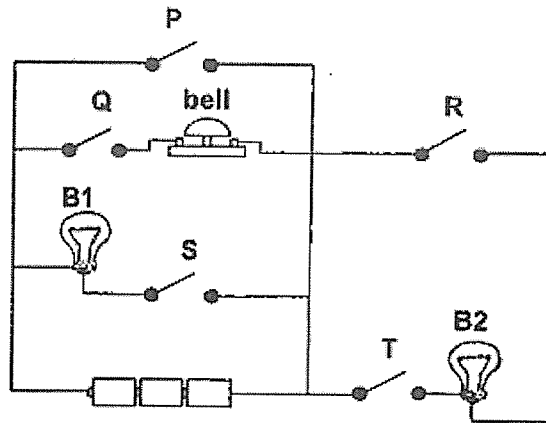

Which of the switches, P, Q, R, S or T have to be closed to ring the bell and to light up bulb B2 only?

- (1) S and T
- (2) P and R
- (3) Q, R and T
- (4) P, Q and S

18. Yi Xuan set up a circuit as shown below using 2 new batteries and 4 working bulbs. The objects were made up of different materials A, B and C.

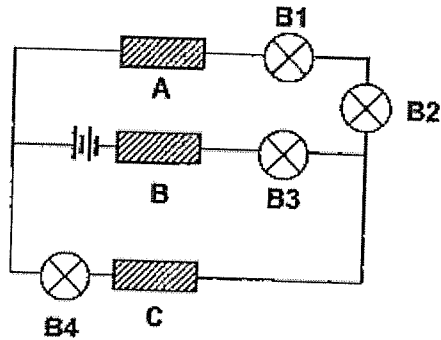

Which materials should be used so that only B3 and B4 would light up?

	Material A	Material B	Material C
(1)	iron	steel	copper
(2)	iron	plastic	rubber
(3)	wood	plastic	copper
(4)	wood	steel	iron

19. Michael set up an electric circuit as shown in the diagram below.

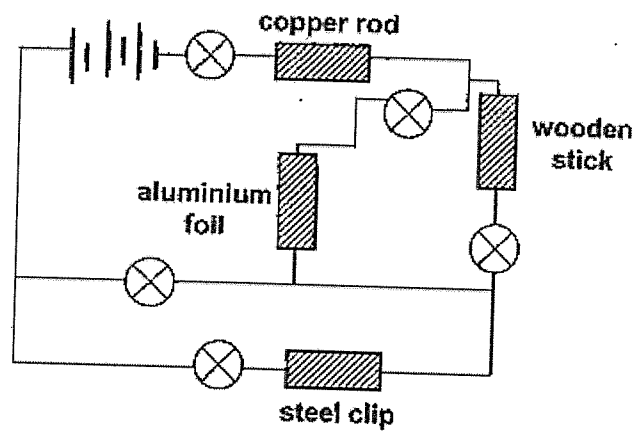

How many light bulbs would light up?

- (1) 5
 (2) 2
 (3) 3
 (4) 4

20. Joash conducted some tests on a circuit and recorded his results in the table below.

Switch A	Switch B	Switch C	Number of bulbs lighted up
closed	closed	open	2
closed	open	closed	3
open	closed	closed	2

Which of the electrical circuits will produce the results recorded in the table shown above?

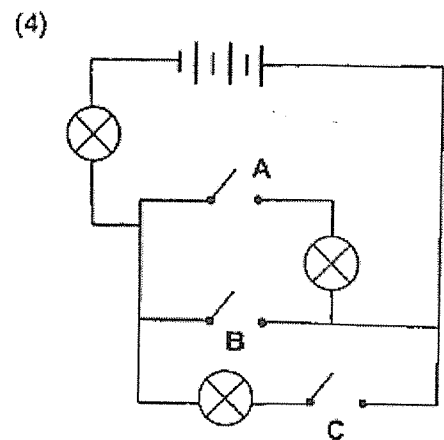
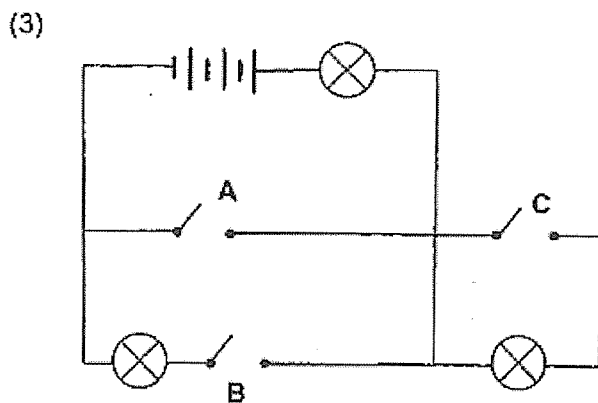
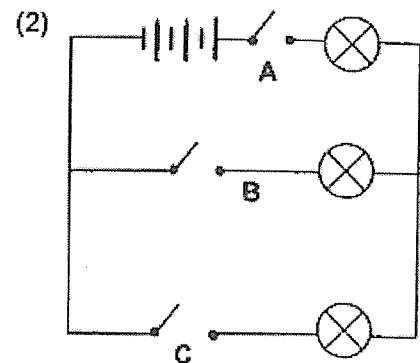
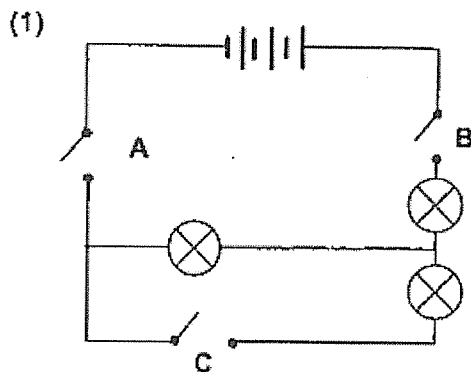

21. In which one of the circuits will bulb B1 be the brightest?

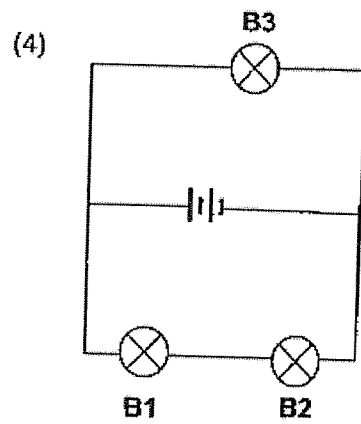
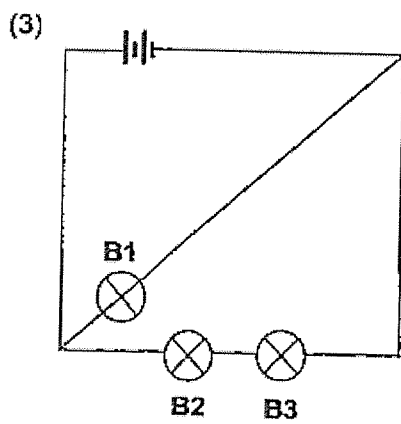
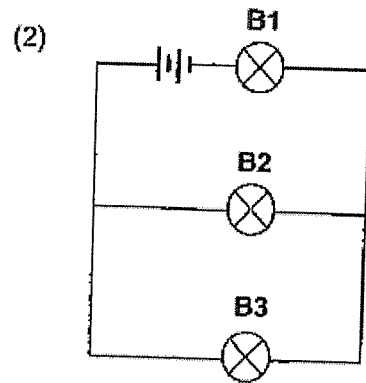
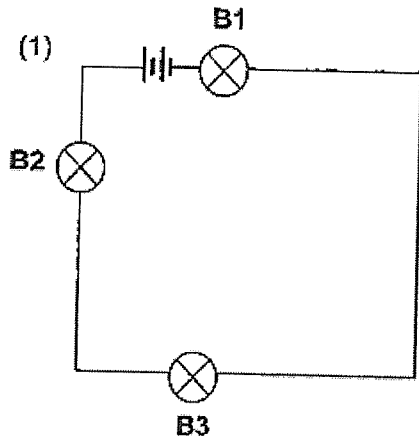

22. The diagrams below show 4 electric circuits, W, X, Y and Z.

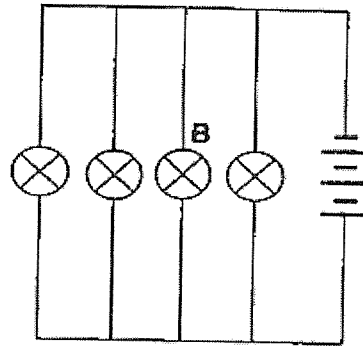

Circuit W

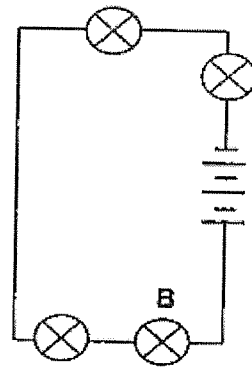

Circuit X

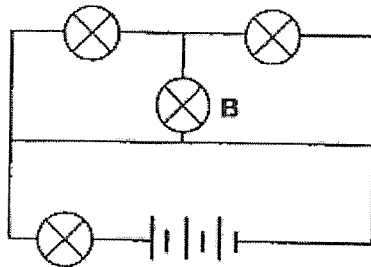

Circuit Y

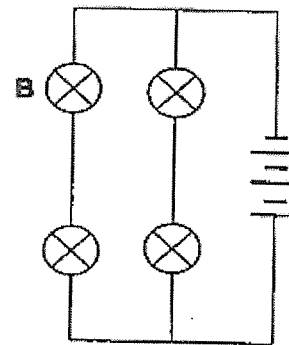

Circuit Z

In which of the circuits would the remaining three bulbs continue to light up if bulb B fuses?

- (1) X and Y
- (2) X and Z
- (3) W and Y
- (4) W, Y and Z

23. The picture below shows an exposed wire.

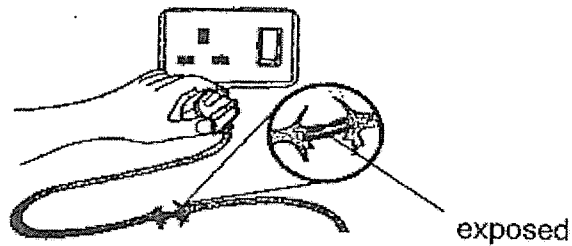

Which of the following statements are correct?

- A Touching the exposed wire with wet hands is dangerous.
- B An electrical conductor is used to wrap around the exposed wires.
- C An exposed wire is unsafe and may cause an electric shock when used.

- (1) A only
- (2) A and B only
- (3) B and C only
- (4) A and C only

24. Which of the following is not a matter?

- (1) Cloud
- (2) Oxygen
- (3) Sunlight
- (4) Steam

25. Qi Xin cut off the base of a plastic bottle. She then tied a balloon to the mouth of the plastic bottle. When she pushed the bottle into a container of water, the water entered the bottle and the balloon became inflated as shown in the diagram below.

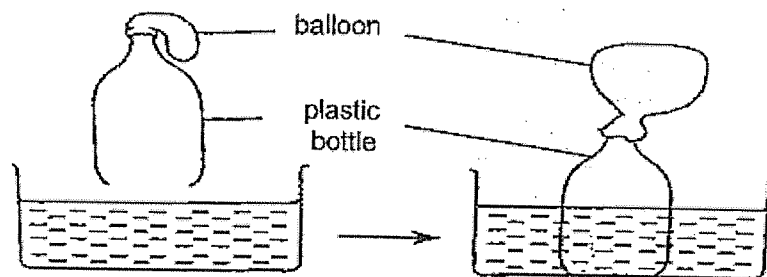

What does the experiment above show?

- (1) Water can be compressed by air.
- (2) Both air and water occupy space.
- (3) Both air and water have a definite mass.
- (4) Both air and water have a definite volume.

26. Mrs. Lim has three identical containers with the capacity of 600 cm^3 . She wanted to use the containers to store substances A, B and C. The table below identifies the substances A, B and C and their volumes.

	Substance	Volume (cm^3)
A	oxygen	800
B	salt	800
C	honey	600

Which of the substance(s) can be fully stored in the container with a tightly covered lid, without the substance(s) overflowing?

- (1) A and B only
 (2) A and C only
 (3) B and C only
 (4) A, B and C
27. Study the diagrams below.

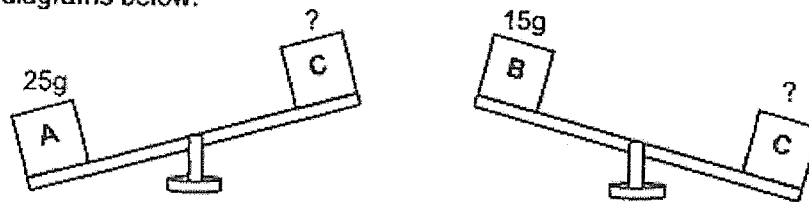

Based on the diagram, what could be the mass of block C?

- (1) 5g
 (2) 10g
 (3) 15g
 (4) 20g
28. The container below has a capacity of 5000 cm^3 . It is filled with 1000 cm^3 of water at first.

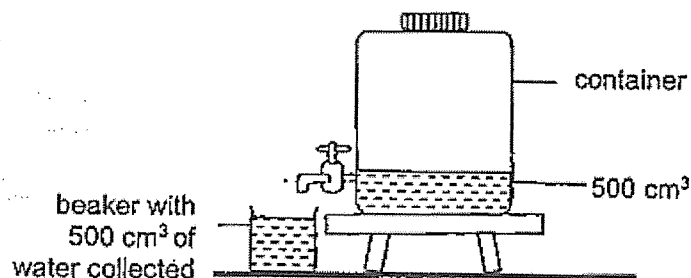

The tap of the container is turned on and 500 cm^3 of water is collected in the beaker. What is the volume of the air in the container?

- (1) 500 cm^3
 (2) 1000 cm^3
 (3) 4000 cm^3
 (4) 4500 cm^3

~ END OF BOOKLET A ~

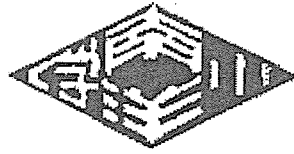

NANYANG PRIMARY SCHOOL

**2023
PRIMARY 5
END-OF-YEAR EXAMINATION**

**SCIENCE
(BOOKLET B)**

Total Time for Booklets A and B: 1 h 45 min

INSTRUCTIONS TO CANDIDATES

1. Write your name and index number in the space provided.
2. Do not open this booklet until you are told to do so.
3. Follow all instructions carefully.
4. Answer all questions.
5. Write your answers to Questions 29 to 40 in the spaces provided.

Booklet A:	56
Booklet B:	44
Total:	100

Name: _____ ()

Class: Primary 5 ()

Parent's signature: _____

Please sign and return the paper the next day. Any queries should be raised at the same time when returning the paper.

Booklet B consists of 15 printed pages including this cover page.

Section B: Open-Ended Questions [44 marks]

29. Kaixin drew a chart of the human body system as shown below.

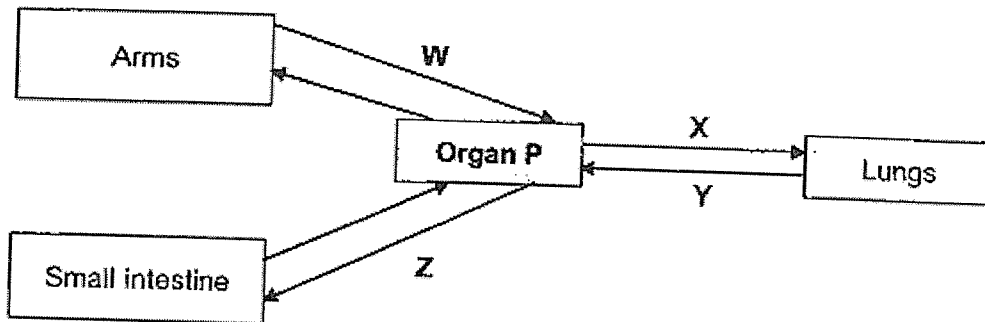

(a) Which organ in the human body system does Organ P represent? Identify the system that organ P is part of.

[1]

(b) Which arrow(s), W, X, Y or Z contain(s) the most amount of oxygen in the blood?

Nadia carried out an experiment to measure the heart rate during two different activities, jogging and reading, for a few minutes, as shown in the graph below.

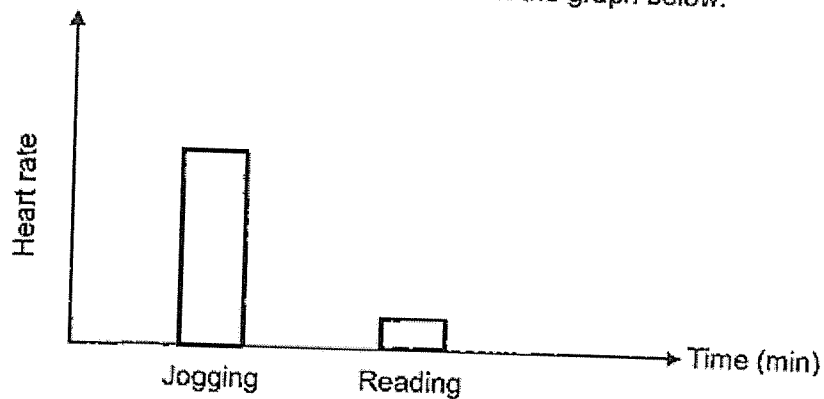

(c) Based on the graph above, explain why Nadia's heart beats faster when she is jogging, as compared to when she is reading.

[2]

30. The diagram below shows the human respiratory system and a leaf.

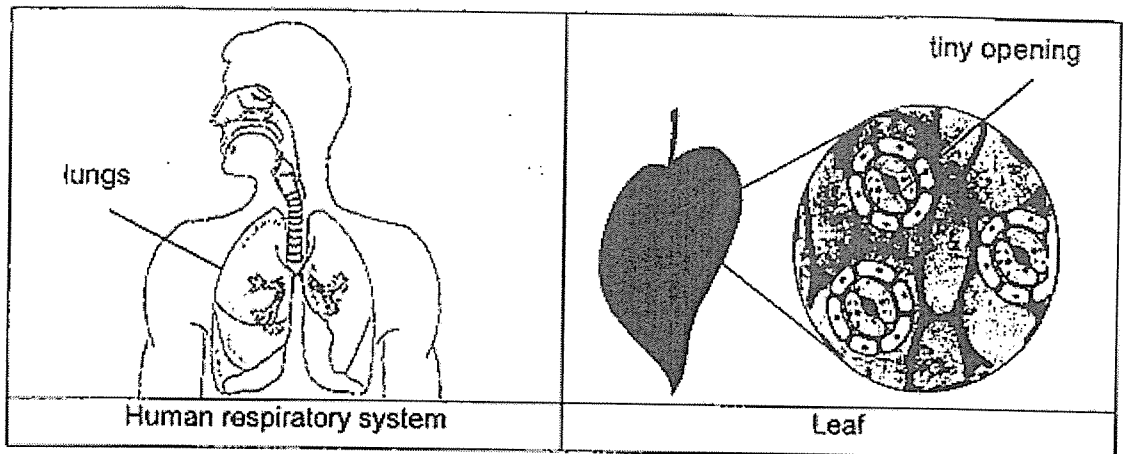

(a) State one similarity in the functions of the lungs and the tiny openings. [1]

(b) Name all the main parts of the human respiratory system. [1]

Samuel coated three leaves, J, K and L of a plant with layers of oil on different parts of the surfaces as shown in the table below.

Leaf	Coated with oil	
	Upper surface of leaf	Lower surface of leaf
J	no	yes
K	no	no
L	yes	yes

He watered the plant daily and observed the leaves for one week. On the 4th day, he observed that leaves L and J had withered and died.

(c) Based on the information above, explain why leaves L and J had withered and died. [2]

31. Qi Jun wanted to find out how the length of the wing-like structure of a fruit affects the time taken by each fruit to reach the ground. He used 3 similar fruits of different lengths of wing-like structure as shown in the diagram below.

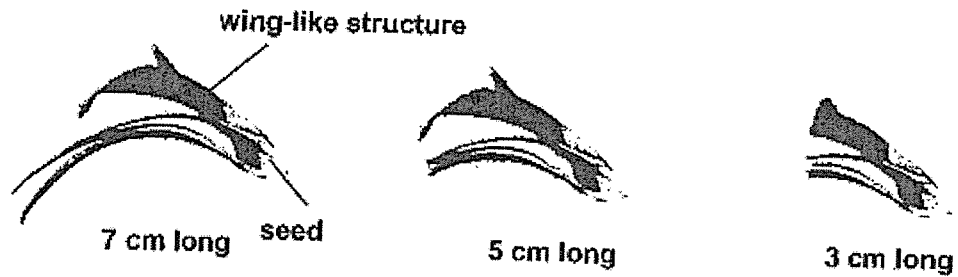

He released each fruit from a height of 1m and recorded the time taken by each fruit to reach the ground, as shown in the table below.

Length of wing-like structure (cm)	Time taken (seconds)			Average
	1 st try	2 nd try	3 rd try	
7	30	28	29	29
5	10	11	9	10
3	4	2	3	3

- (a) Based on the results of Qi Jun's experiment,
- (i) State the relationship between the length of the wing-like structure of the fruit and the time taken for the fruit to reach the ground. [1]
- _____
- _____
- (ii) Explain how the wing-like structure helps in the dispersal of the fruit. [1]
- _____
- _____
- (b) Why did Qi Jun release all the 3 fruits from the same height? [1]
- _____
- _____

Continue from previous page

Qi Jun went into the forest and found 2 fruits, A and B. He observed the dispersal pattern of the seeds as shown in the diagram below.

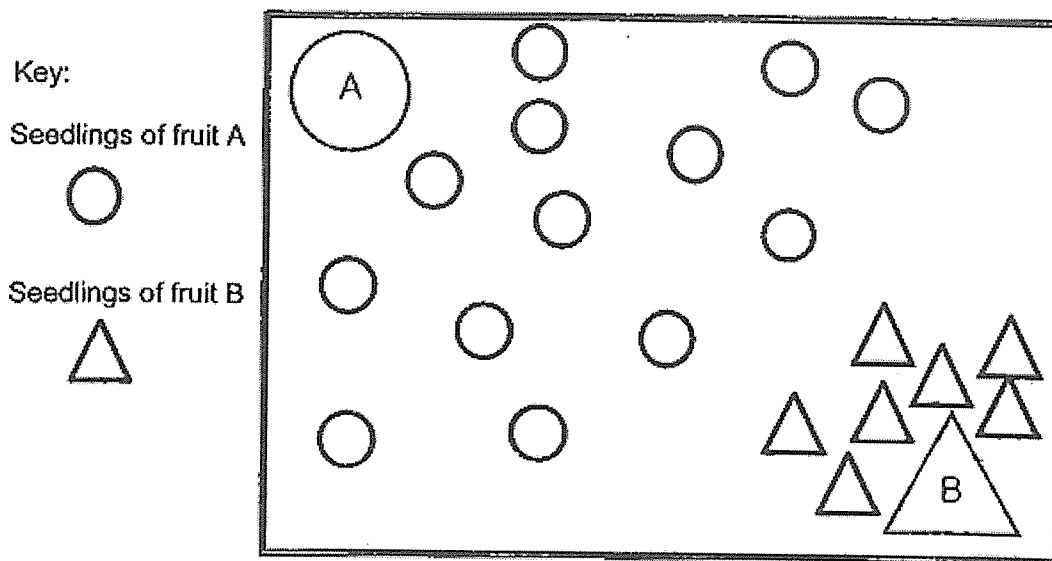

- (c) Based on the diagram, which seedling will grow less healthily?
Explain your answer.

[2]

32. Study the flow chart below.

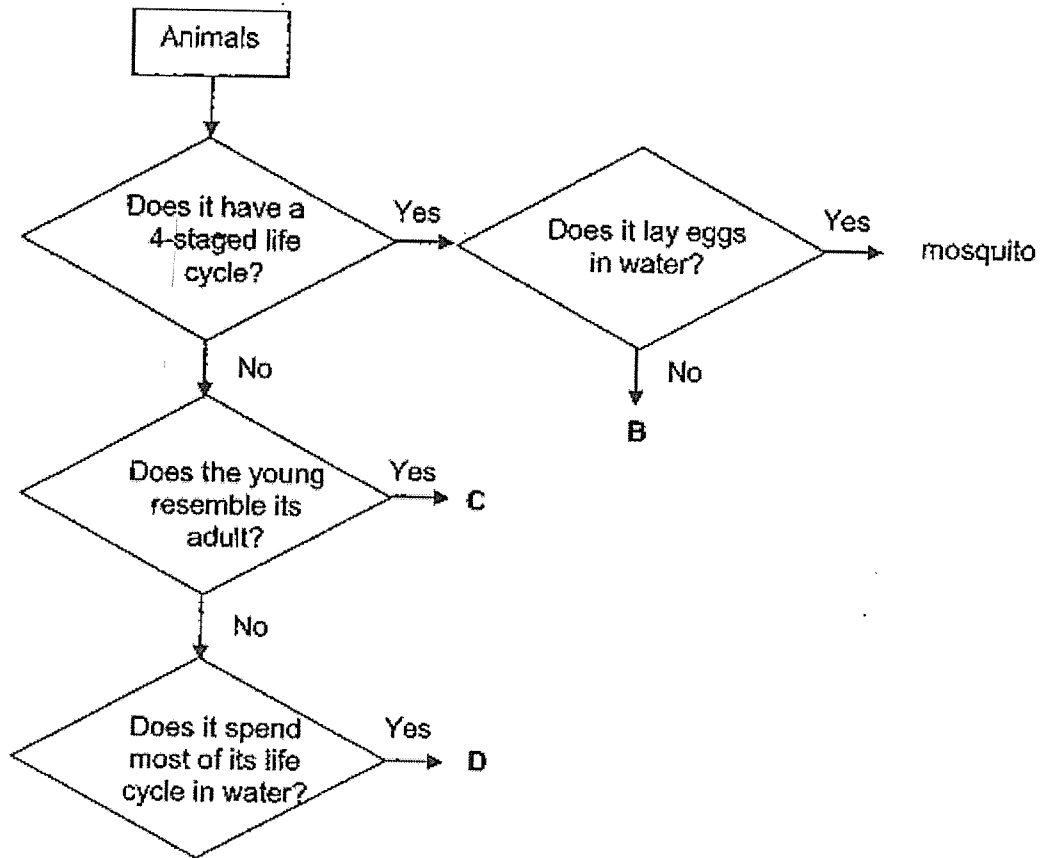

(a) Based on the flowchart above, state one similarity and one difference between animals C and D. [2]

(i) Similarity: _____

(ii) Difference: _____

(b) Based on the flow chart above, state an example of animal B. [1]

Mosquito larva and pupa are commonly found just beneath the water surface.

(c) How does spraying a layer of oil onto the water surface kill them? [1]

33. Wei Ling conducted an experiment as shown in the diagram below. She placed set-up G and set-up H inside two identical cupboards. She observed the growth of the seeds after 5 days.

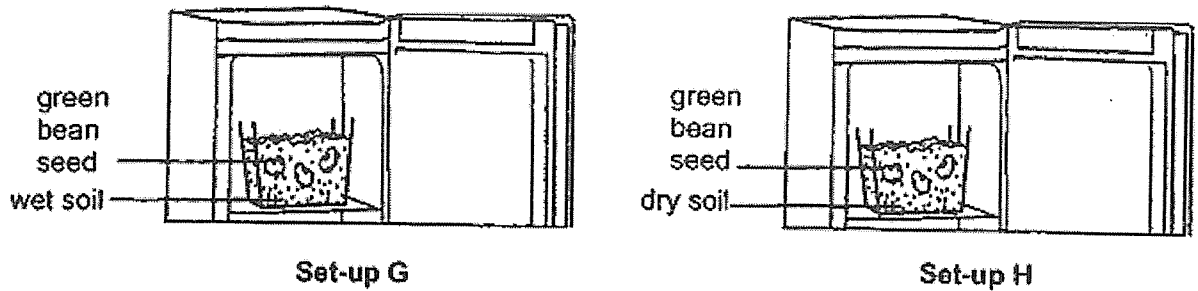

- (a) Based on the diagram above, what was the aim of Wei Ling's experiment? [1]

- (b) State two variables which must be kept constant in this experiment. [1]

(i) _____

(ii) _____

- (c) Draw the 3-staged life cycle of a bean plant. [1]

A large empty rectangular box provided for the student to draw the 3-staged life cycle of a bean plant.

34. The diagram below shows a skeleton.

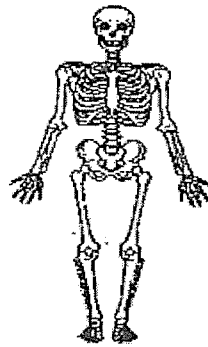

(a) State the system that works with the skeletal system to enable us to move. [1]

(b) State another function of the skeletal system. [1]

35. Mrs. Lim wanted to find out how the size of the bread affect the rate of digestion in our body. She cut 3 similar pieces of bread E, F and G, as shown in the diagram below.



Bread E



Bread F



Bread G

She then added the same amount of digestive juice to each bread. She waited for 5 hours before she weighed the bread again.

The graphs below show the changes in the mass of bread at the start and at the end of 5 hours.

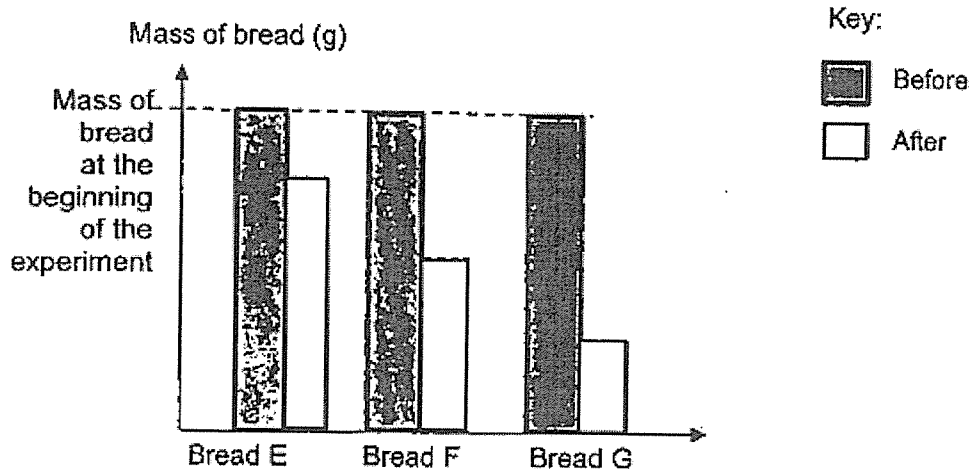

- (a) State the changed variable of the experiment. [1]

- (b) Describe and explain how the size of the bread affects its rate of digestion. [2]

36. At the DEF market, the meat sellers will display the meat in a meat chiller as shown in the diagram below.

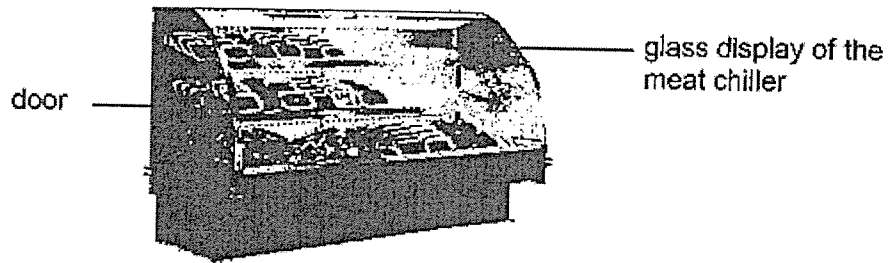

The temperature inside the meat chiller is at 4°C . The temperature outside the meat chiller is at 30°C . As the time passes, water droplets are seen forming on the front glass display.

- (a)(i) Draw the water droplets on the correct side of the glass display in the diagram below. [1]

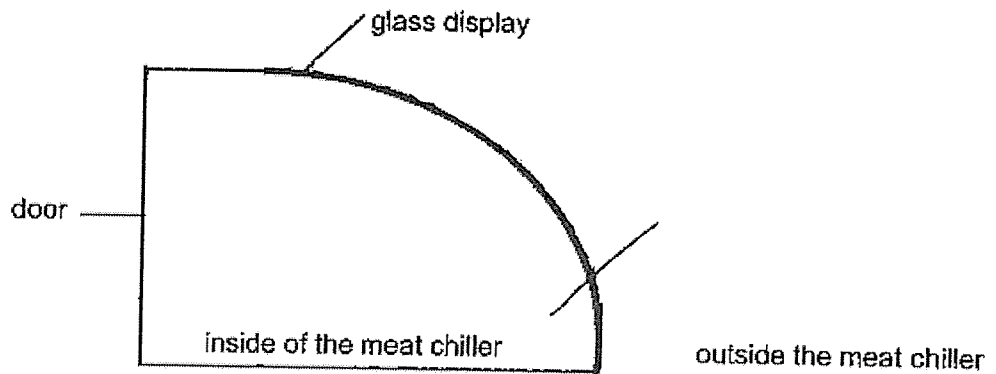

- (ii) Explain how the water droplets are formed. [2]

The door of the meat chiller was accidentally left open for 20 minutes. Less water droplets are observed on the glass display.

- (b) Give a reason why this happened. [1]

Continue from previous page

At the end of the day, the meat seller washes the trays which are used to display the meat. He then places them on the rack or stacks them as shown below.

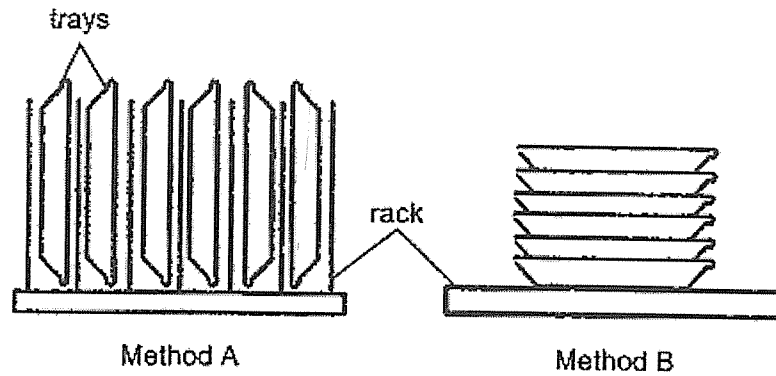

- (c) Based on the diagram above, which method, A or B, should the meat seller use to dry the trays faster? Explain your answer. [1]

37. Qi Ying placed a lump of playdough gently into a beaker containing 200 cm^3 of water until it is fully submerged. The water level rose as shown in the diagram below.

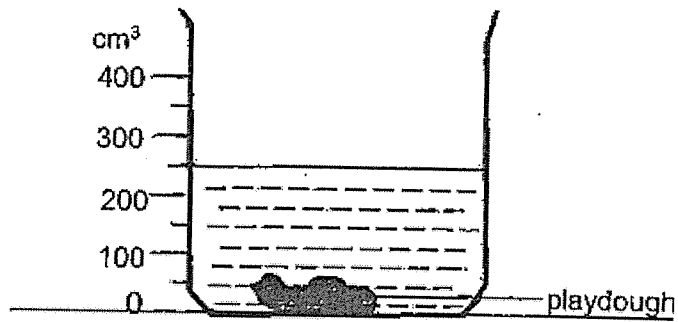

- (a) What is the volume of the playdough? [1]

The same lump of playdough is then removed from the beaker and rolled into a ball. It is then put back into the same beaker that contained the same 200 cm^3 of water.



- (b) What will happen to the water level as compared to the water level shown in the above diagram? Explain your answer. [2]

A metal cube with a volume of 150 cm^3 is put into the beaker containing 200 cm^3 of water, together with the same lump of playdough, as shown below.

- (c) Draw the new water level in the diagram below. [1]

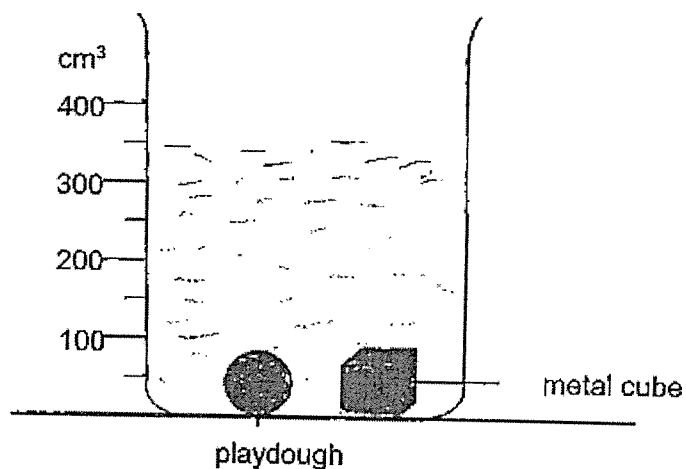

38. Lucas set up an electrical circuit with 2 working batteries, 3 working bulbs, P, Q and R and 4 switches, S1, S2, S3 and S4, as shown below.

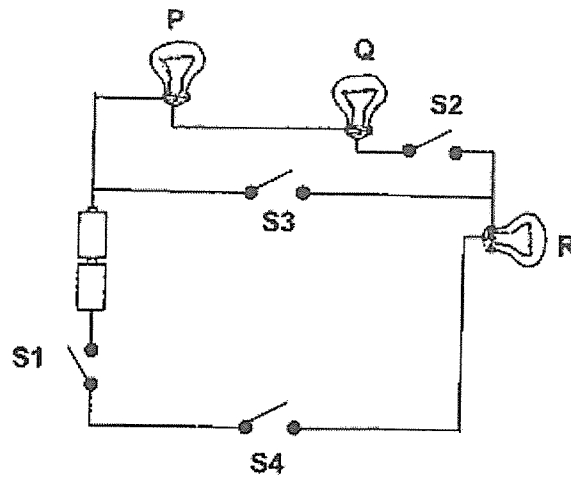

- (a) Which switch(es) must be closed in order for only bulb R to light up? [1]

- (b) When only S1 is opened, Lucas noticed that all the bulbs did not light up. Explain why. [1]

39. Julie had three rods, W, X and Y, made of different materials. She placed the rods at different positions in the circuit as shown below.

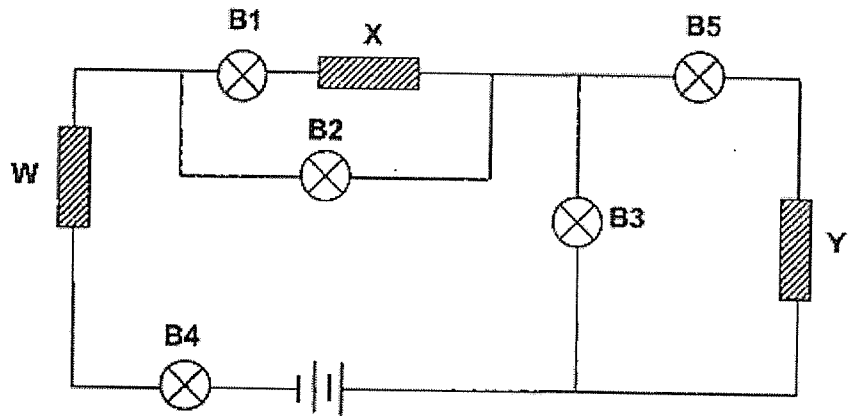

Bulb B2, B3, B4, B5 was lighted up.

- (a) What can Julie conclude about the property of material Y based on the diagram above? [1]

All the batteries and bulbs are in working condition.

- (b) Explain why only B1 did not light up. [2]

40. Li Pin set up a circuit with three different coloured bulbs as shown below.

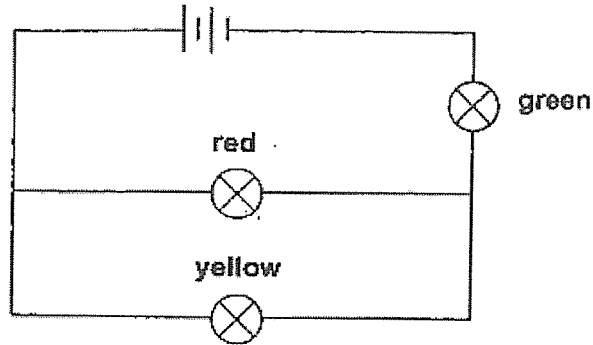

- (a) Mark with an 'X' in the circuit above where the switch should be placed so that all the bulbs can be turned on and off together at the same time. [1]
- (b) What would Li Pin observe about the other 2 bulbs if the red coloured bulb fuses? Explain Li Pin's observations. [2]
-
-

Li Pin wants to rearrange the circuit such that the bulbs will only light up one at a time.

- (c) Complete the circuit diagram below by drawing the following: [2]
- 3 switches
 - 3 coloured light bulbs
 - 2 batteries

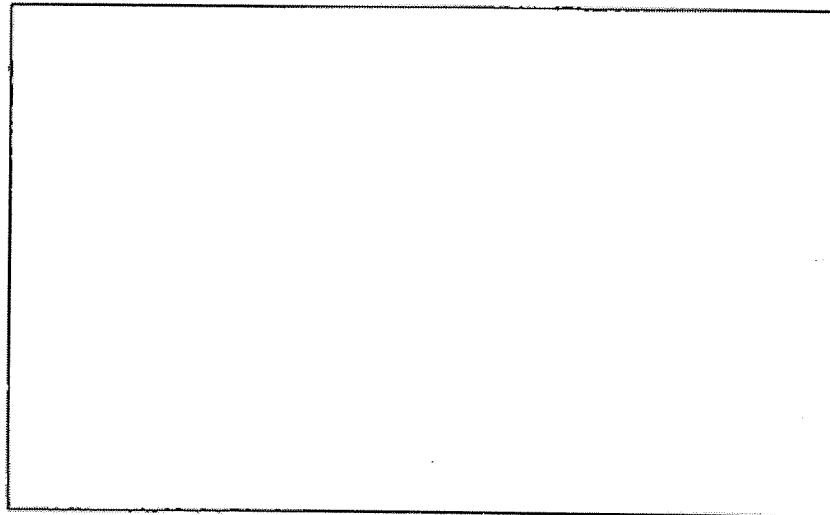

~ END OF BOOKLET B ~

Suggested Answer Key – P5 EYE 2023

Qn	Ans	Qn	Ans	Qn	Ans	Qn	Ans	Qn	Ans	Qn	Ans
1	1	6	2	11	3	16	1	21	3	26	2
2	4	7	1	12	1	17	3	22	3	27	4
3	4	8	3	13	1	18	4	23	4	28	4
4	4	9	1	14	3	19	4	24	3		
5	3	10	3	15	4	20	4	25	2		

Qns No		Answer
29	a	Organ P: Heart. Circulatory System
	b	Y
	c	The heart pumped blood faster to transport more oxygen and digested food to all parts of the body and remove more carbon dioxide and waste materials away from the body.
30	a	Both allow gases to enter and leave the parts.
	b	Nose, windpipe and lungs
	c	Data: Oil covered the tiny openings on the lower and upper surfaces of the leaf Explanation: There will be no gaseous exchange with the surroundings
31	ai	As the length of the wing-like structure increases (cause), the time taken for the fruit to reach the ground increases (effect).
	aii	The wings allow the fruit to float in the air longer and so it can be carried over the greater distance.
	b	To ensure that there is only one changed variable which is the length of the wing.
	c	Choice: Fruit B. Data: The seedlings are close together. Explain: Due to overcrowding, the seedlings of fruit B will have to compete with others for water, sunlight, mineral salts and (space)
32	ai	Both have 3-staged life cycle.
	aii	The young of C resembles its adult but the young of D does not resemble its adult.
	b	Butterfly/ mealworm beetle/moth
	c	The oil will block the breathing tube so there is a lack of air/oxygen.
33	a	To find out how water affects the germination of seeds.
	bi	The temperature of surroundings /The number/type of beans in each set-up/The
	bii	type/amount of soil added in each set-up
	c	<pre> graph TD Seed --> Adult["Adult(bean)plant"] Seed --> Young["Young plant/seedling"] Young --> Adult </pre>
34	a	Muscular system
	b	To protect our (internal) organs/give body its shape
35	a	The size/ exposed surface area of the bread
	b	Data: Cutting breaks the bread down into smaller pieces/simpler substances. Explain: The bread will be more exposed surface area in contact with the digestive juices.

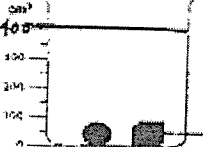
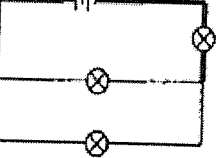
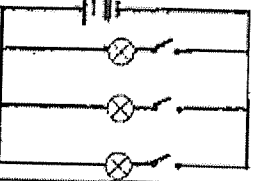
36	ai	
	aii	<p>The temperature outside the meat chiller is higher than the temperature inside. The warmer water vapour from the surroundings lost heat to the cold surface of the glass display and condensed into water droplets on the outside of the meat chiller.</p>
	b	<p>The temperature difference between the temperature inside and outside the meat chiller decreased, thus the rate of condensation decreased.</p>
	c	<p>Choice: Method A Data: water will drip downwards or sideways on the trays./ more exposed surface area Explain: Less water left on the trays will be evaporated.</p>
37	a	50 cm ³
	b	<p>Choice: The water level will remain at the same level. Data: Only the shape has changed but the volume remained the same. Explain: The playdough has a definite volume/ will occupy the same amount of space.</p>
	c	
38	a	S1, S3 and S4
	b	There is an open circuit, so the electric current cannot flow through the circuit.
39	a	Electrical conductor
	b	X is an electrical insulator, so no electric current flow through the path/wire to light up bulb B1.
40	a	 <p>Mark X anywhere along the bold wire.</p>
	b	<p>The yellow and green bulbs remained lit. Electric current could still flow through the amber and green bulbs in the circuit/the circuit was still in a closed circuit with the batteries.</p>
	c	 <p>Correct arrangement of all bulbs - parallel Correct positions of all switches Correct circuit symbols of all electrical components Correct number of batteries, bulbs and switches</p>