



**Anglo-Chinese School  
(Primary)**

A Methodist Institution  
(Founded 1886)

**END OF YEAR EXAMINATION 2023  
SCIENCE  
PRIMARY FIVE  
BOOKLET A**

Name: \_\_\_\_\_ (     )

Class: Primary 5 \_\_\_\_\_

Date: 26 October 2023

Total Time for Booklets A and B: 1 h 45 min

**INSTRUCTIONS TO CANDIDATES**

1. Write your name, register number and class in the spaces provided.
2. Do not turn over this page until you are told to do so.
3. Follow all instructions carefully.
4. Answer all questions.
5. Shade your answers on the Optical Answer Sheet (OAS) provided.

This booklet consists of 18 printed pages including this cover page.

For each question from 1 to 28, four options are given. One of them is the correct answer. Make your choice (1, 2, 3 or 4) and shade your answer on the Optical Answer Sheet.

(56 marks)

- 1 The diagram shows a rectangular metal frame with four drops of wax attached at P, Q, R and S.

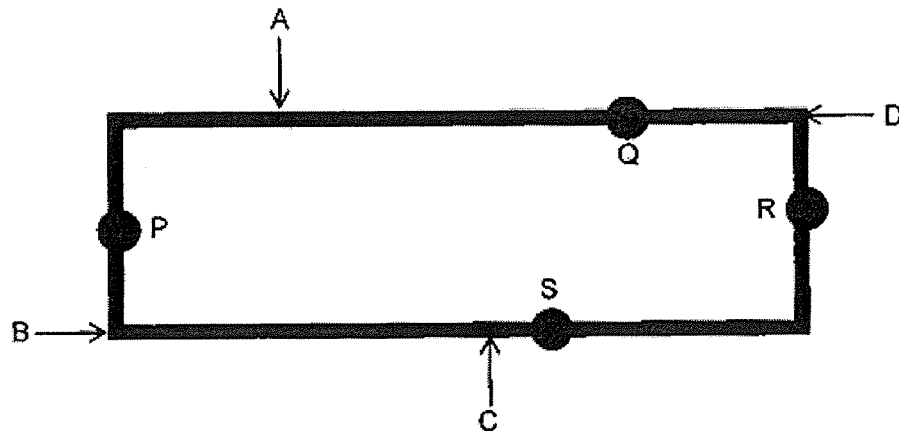

Max heated the metal frame at one of the points, A, B, C or D. He then recorded the time taken for each drop of wax to melt in the table as shown.

Position of the drop of wax	Time taken for the drop of wax to melt (s)
P	95
Q	25
R	19
S	40

At which point did Max apply the source of heat?

- (1) A
- (2) B
- (3) C
- (4) D

- 2 Two identical flasks, A and B, were connected to an air pump as shown in the diagram. Flask B contained 200 cm<sup>3</sup> of water. The set-up is air-tight.

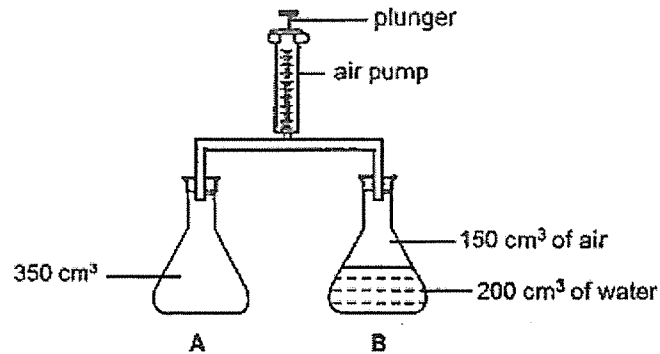

The plunger of the air pump was pushed down, releasing 100 cm<sup>3</sup> of air into the flasks.

What is the final volume of air in each flask at the end of the experiment?

	Flask A (cm <sup>3</sup> )	Flask B (cm <sup>3</sup> )
(1)	350	150
(2)	350	250
(3)	450	150
(4)	450	250

- 3 Object A was freely suspended in the air as shown in the diagram. A bar magnet was brought close to object A.

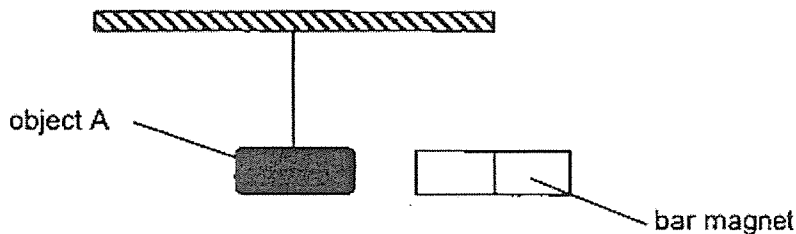

After observing the interaction between the bar magnet and object A, John concluded that object A is a magnet.

Which of the following best describes John's observation?

- (1) Object A remained still.
- (2) Object A swung left and right repeatedly.
- (3) Object A moved towards the bar magnet.
- (4) Object A moved away from the bar magnet.

4 Study the classification chart.

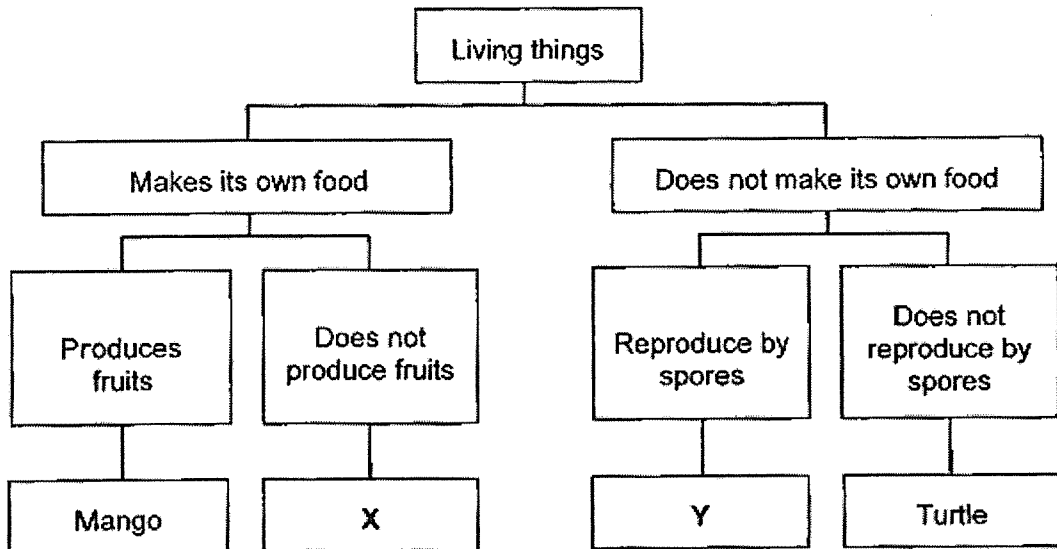

Which of the following is correct for X and Y?

	X	Y
(1)	fern	mushroom
(2)	moss	fern
(3)	mushroom	bacteria
(4)	bacteria	moss

- 5 Ryan cut an outer ring of the stem between positions P and Q of a plant as shown in the diagram. The food-carrying tubes between positions P and Q were removed while the water-carrying tubes remained in the stem.

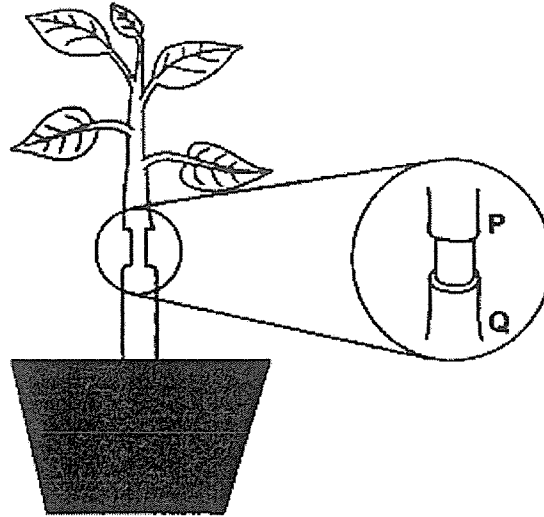

After a few days, he observed that one part of the stem was swollen.

Which one of the following answers is correct?

	Swollen Part	Reason
(1)	P	Water absorbed by the roots had travelled upwards and collected at P.
(2)	P	Food made by the leaves was unable to travel downwards and collected at P.
(3)	Q	Water absorbed by the roots was unable to travel upwards and collected at Q.
(4)	Q	Food made by the leaves had travelled downwards and collected at Q.

- 6 The table shows the breathing rates of people of different age groups when they are at rest and during exercise.

Age group (years old)	Breathing rate (units per minute)	
	At rest	During exercise
3 to 6	28	39
7 to 12	23	27
13 to 21	19	21
21 to 64	15	19
Above 65	12	15

From the information given above, what can be concluded about the breathing rate of a person?

- (1) The breathing rate of a person increases with exercise.
  - (2) As a person gets older, his/her breathing rate increases.
  - (3) The breathing rate of a person is not affected by his/her age.
  - (4) The amount of exercise performed by a person affects his/her breathing rate.
- 7 A group of people stayed in a poorly ventilated room for a few hours. The following graph shows the changes in the amount of gases in the room.

Amount of gases (cm<sup>3</sup>)

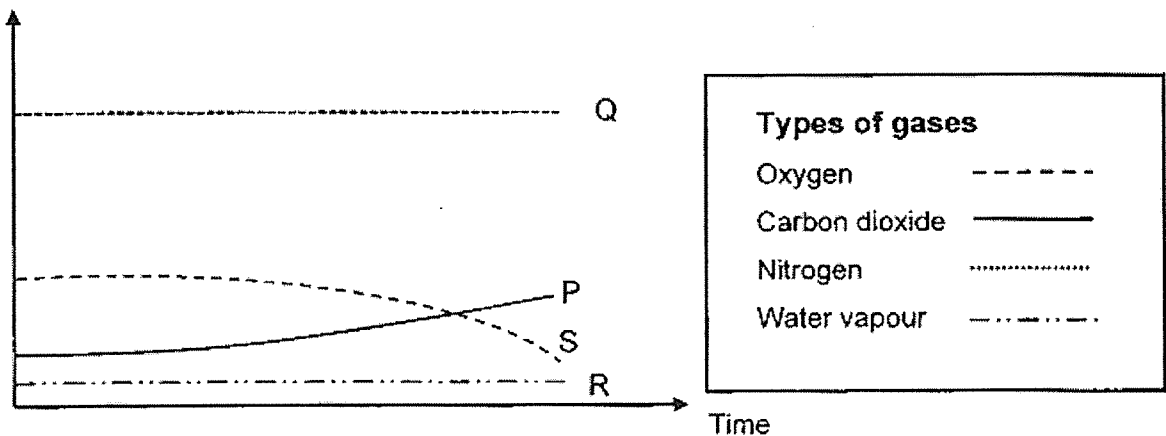

Which of the following graphs is most likely to be wrong?

- (1) P
- (2) Q
- (3) R
- (4) S

- 8 Sham was making comparisons between how a man and a fish breathe.

	Man	Fish
A	Air containing oxygen enters through the nose and gets into the lungs.	Water containing dissolved oxygen enters through the mouth and passes over the gills.
B	Oxygen from the air gets into the lungs directly.	Oxygen from the air gets into the gills directly.
C	Carbon dioxide passes into the lungs and is removed when breathed out.	Dissolved carbon dioxide is carried away as water flows out from under the gill covers.

Which of the above comparisons are true?

- (1) A and B only  
 (2) A and C only  
 (3) B and C only  
 (4) A, B and C only
- 9 Bob did a cross-section of Leaf G of a land plant and observed it under a microscope. He observed parts H as shown.

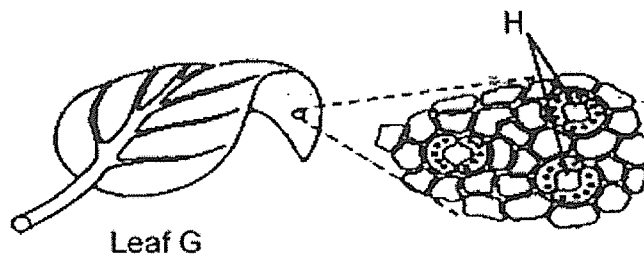

Which of the following statements are true about part H?

- A They allow the exchange of gases to take place.  
 B They trap sunlight needed to make food for the plant.  
 C They are usually found on the lower part of leaves away from sunlight.  
 D They allow water vapour to escape from the plants.
- (1) A and C only  
 (2) B and D only  
 (3) B, C and D only  
 (4) A, C and D only

10 Blood samples were taken from the blood vessels, P and Q, in a human circulatory system.

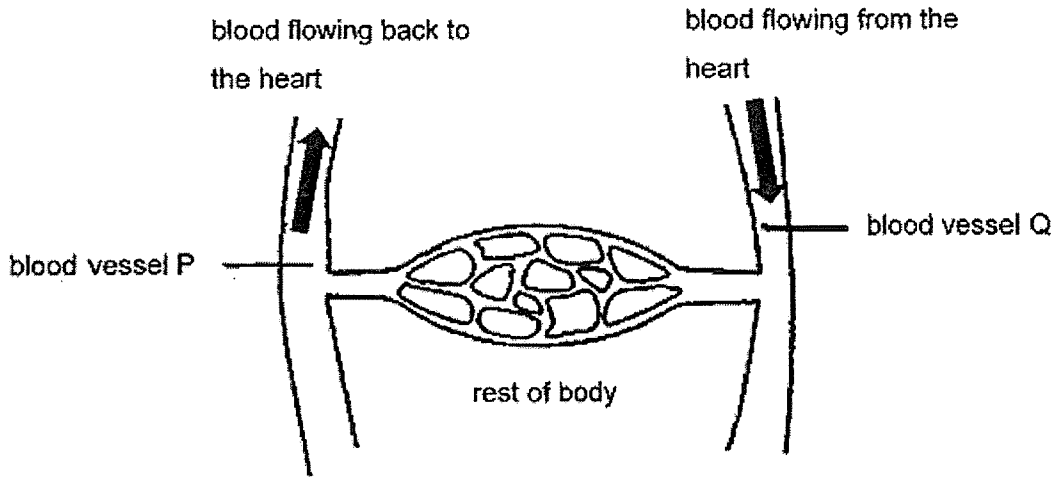

Which graph correctly represents the amount of carbon dioxide in the blood vessels?

(1) Amount of carbon dioxide

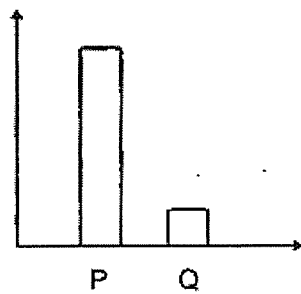

(2) Amount of carbon dioxide

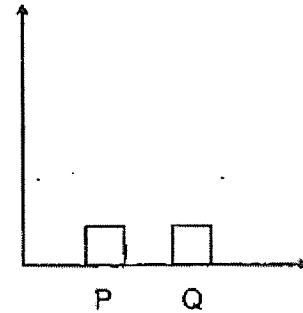

(3) Amount of carbon dioxide

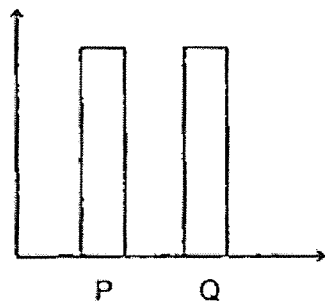

(4) Amount of carbon dioxide

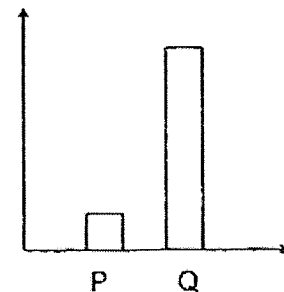



11 Study the circuits.

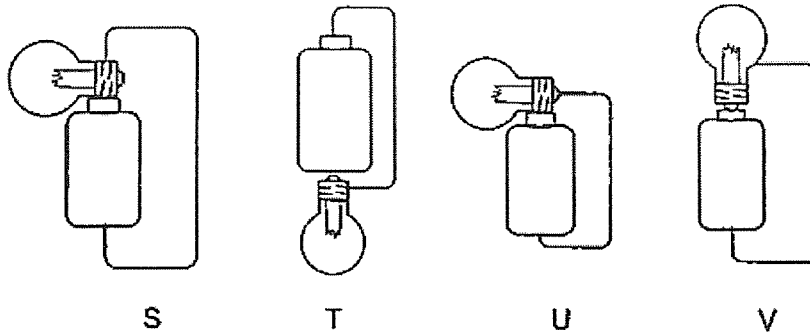

In which of the circuits will the bulb light up?

- (1) S and V only
- (2) T and U only
- (3) S, T and V only
- (4) T, U and V only

12 Study the electric circuit as shown.

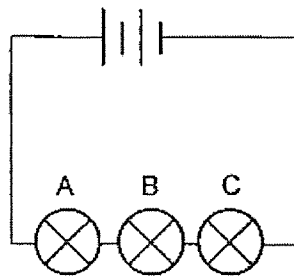

What will happen to the brightness of bulb A if bulb B is removed and replaced with a piece of wire?

- (1) Bulb A will become brighter.
- (2) Bulb A will become dimmer.
- (3) Bulb A will no longer light up.
- (4) Bulb A will be as bright as before.

13 Ravi sets up the circuit as shown.

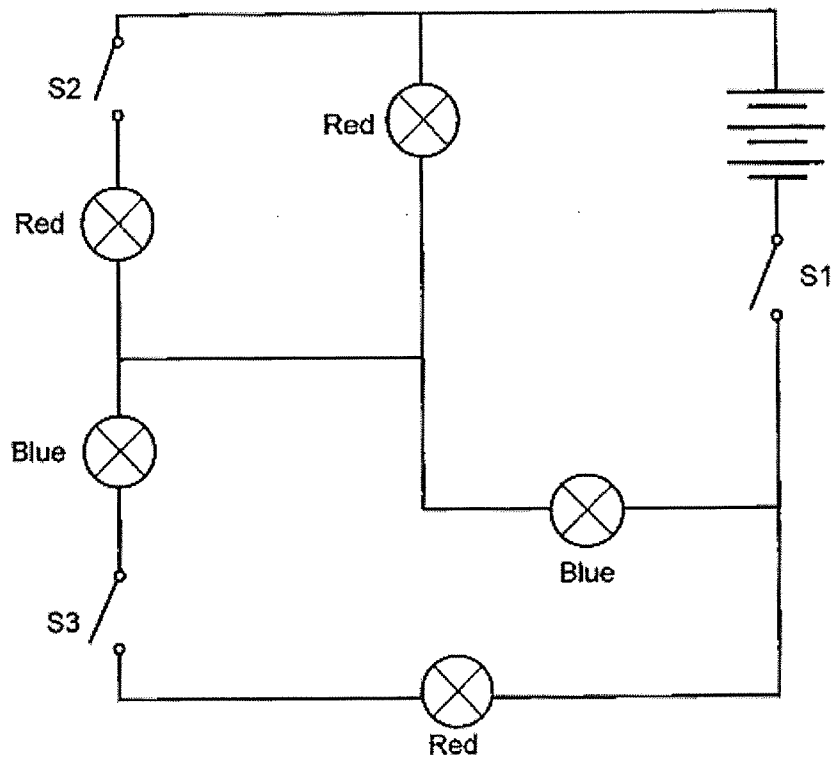

Which switches (S1, S2, S3) should Ravi close so that only two blue bulbs and two red bulbs are lighted up at the same time?

- (1) S1 and S2
- (2) S1 and S3
- (3) S2 and S3
- (4) S1, S2 and S3

- 14 Keith set up the following electrical circuits to find out if materials W, X, Y and Z are conductors or insulators of electricity.

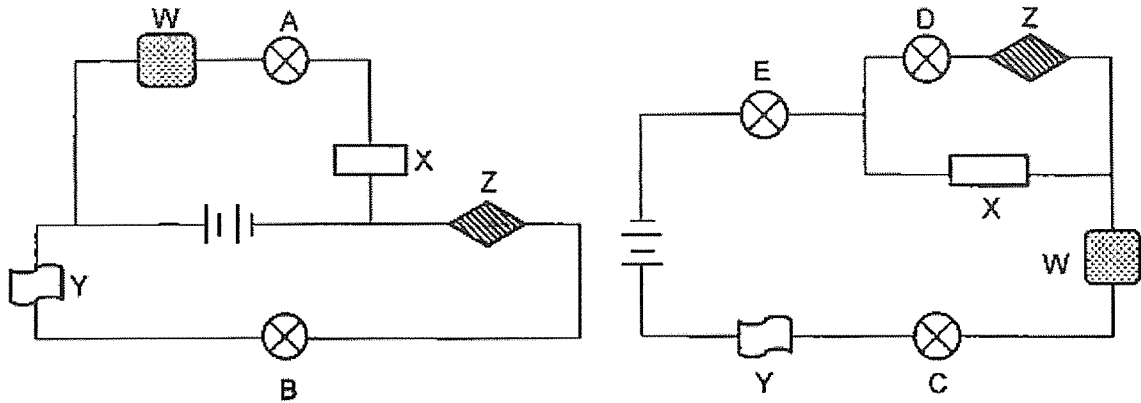

The table shows the results of his test.

Bulb	Did the bulb light up?
A	Yes
B	No
C	Yes
D	No
E	Yes

Which one of the following correctly identifies the conductor(s) and insulator(s) of electricity?

	Conductors of electricity	Insulators of electricity
(1)	Z	W, X, Y
(2)	W, X	Y, Z
(3)	W, X, Y	Z
(4)	W, Z	X, Y

- 15 Ravi wanted to find out if the arrangement of bulbs affects the brightness of the bulb. Which two circuits should he use?

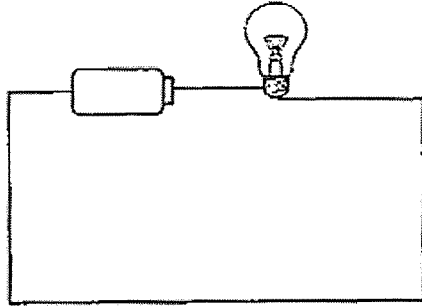

Circuit A

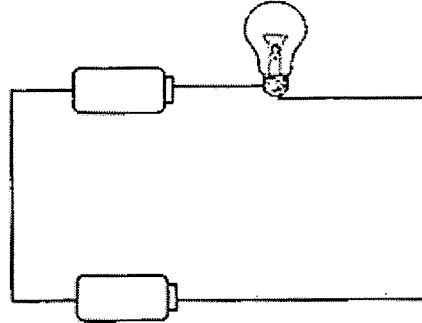

Circuit B

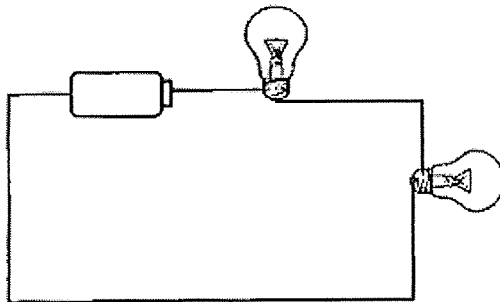

Circuit C

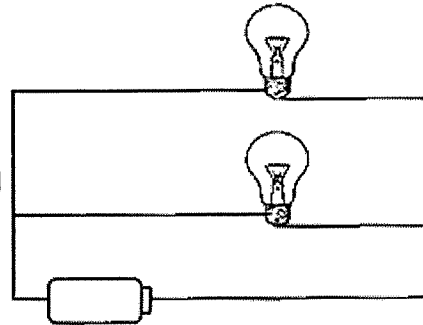

Circuit D

- (1) A and B  
 (2) A and D  
 (3) C and B  
 (4) C and D
- 16 Which of the following are ways to conserve electricity?

- A Switch to energy-saving light bulbs.  
 B Turn off the electrical appliances when not in use.  
 C Use the air conditioner instead of a fan on a cool day.  
 D Falling asleep with the TV switched on.

- (1) A and B only  
 (2) A and C only  
 (3) B and D only  
 (4) A, C and D only

- 17 The table shows the traits of Siti and her family members.

	Length of fingernails	Eyelids	Earlobes
Siti	short	double	attached
Siti's father	short	single	attached
Siti's mother	short	double	detached
Siti's brother	long	single	detached

Which one of the following statements is true about Siti's family?

- (1) Siti inherited her short fingernails from both her parents.
  - (2) Siti's brother inherited his detached earlobes from his father.
  - (3) Siti did not inherit any of the three traits from her mother.
  - (4) Siti's brother inherited his single eyelid from his father.
- 18 Ali observed some leaf cells using a microscope. The cells are shown in the diagram. The parts of the cells are labelled as A, B, C and D.

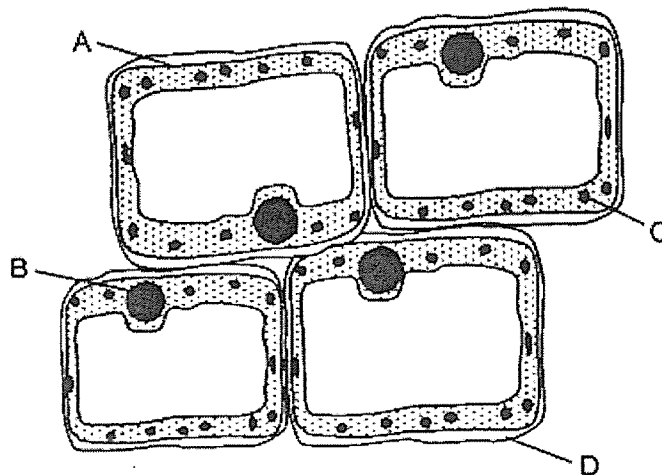

Which of the following parts of the cells have been correctly matched to their functions?

	Contains the genetic information of the plant	Traps light energy from the Sun to make food	Supports and gives the cell a regular shape
(1)	B	D	A
(2)	C	B	A
(3)	B	C	D
(4)	C	B	D

- 19 The diagram shows a fruit containing seeds.

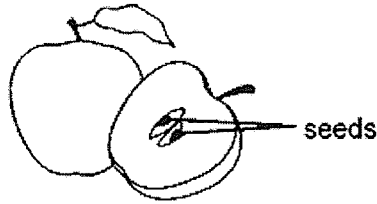

Which one of the following statements is true about the seeds?

- (1) The seeds are dispersed by splitting action.
  - (2) The seeds develop from the ovule of the flower.
  - (3) The seeds need only water to grow into a new plant.
  - (4) Only pollination needs to take place for the seeds to be produced.
- 20 Ali wants to find out if substance Y affects the amount of substance Z taken in by cell A.

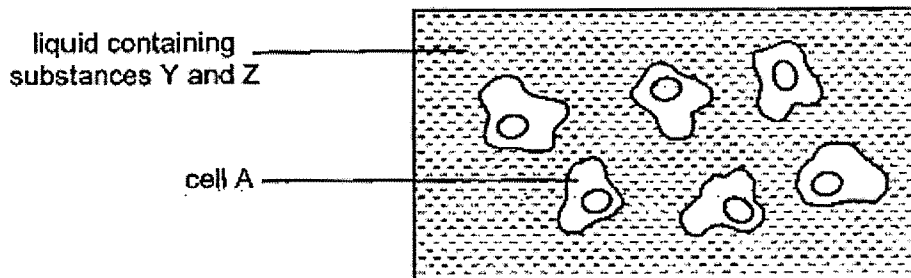

He prepared four set-ups as shown.

Set-up	Number of cell A	Amount of substance Y in liquid (units)	Amount of substance Z in liquid (units)
1	6	20	50
2	6	25	50
3	6	30	50
Control	6	?	?

What amounts of substance Y and substance Z in the liquid should Ali add into the control set-up?

	Amount of substance Y (units)	Amount of substance Z (units)
(1)	0	50
(2)	0	0
(3)	20	0
(4)	50	0

- 21 The female reproductive system in a human and a flower are shown in the diagrams.

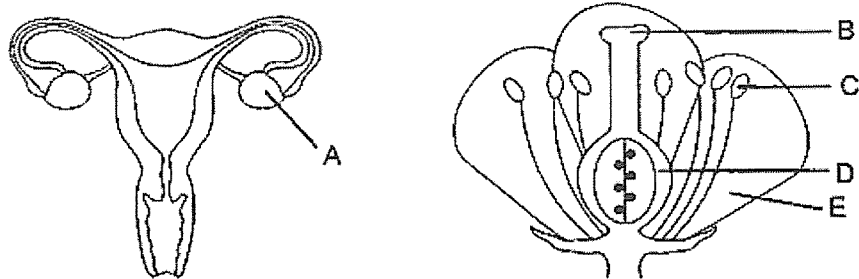

Which part of the flower has a similar function as organ A?

- (1) B  
 (2) C  
 (3) D  
 (4) E
- 22 Which of the following statements about human reproduction is **not** correct?
- (1) Only one sperm will fuse with an egg.  
 (2) The fertilised egg will develop in the ovary.  
 (3) Fertilisation occurs in the female reproductive system.  
 (4) The fertilised egg contains genetic information of both parents.
- 23 Which of the following correctly describes the transfer of pollen grains during pollination?

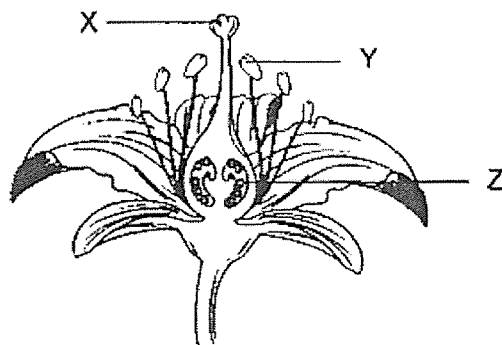

- (1) From X to Y  
 (2) From X to Z  
 (3) From Y to X  
 (4) From Y to Z

- 24 Oliver performed an experiment using two flowers, A and B, from the same plant. One of the flowers is as shown.

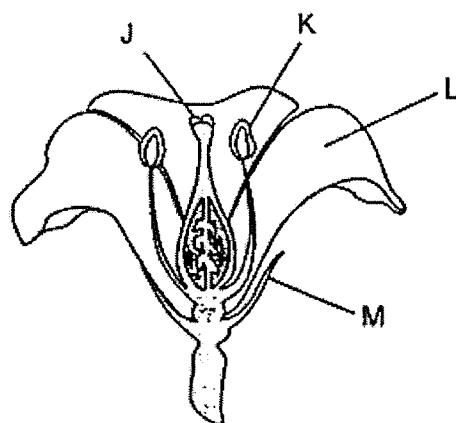

He removed one part from flower A and one part from flower B. After some time, he recorded which flower could form a fruit.

Flower	A	B
Presence of a fruit	Yes	No

Which of the following correctly shows the part of each flower that has been removed?

	Part removed	
	Flower A	Flower B
(1)	J	L
(2)	K	M
(3)	L	K
(4)	M	J



- 25 Sheila poured 100 ml of water into a beaker and placed it in a classroom. She measured the volume of the water left in the beaker over a few hours and plotted her results in the graph.

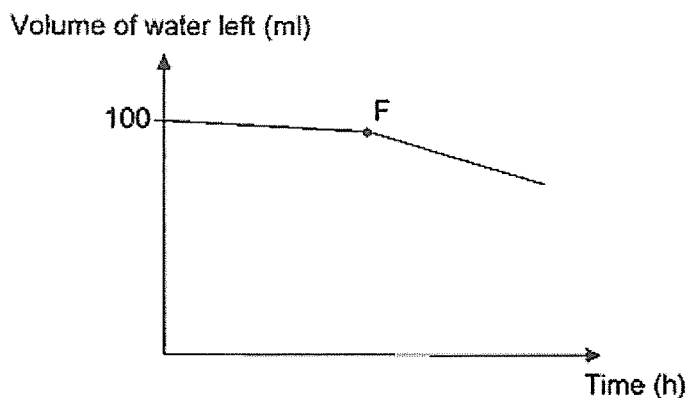

Which of the following changes did Sheila make at point F of the graph?

- (1) She placed ice into the beaker.
  - (2) She covered the beaker with a lid.
  - (3) She poured hot water into the beaker.
  - (4) She switched on the fans in the classroom.
- 26 The table below shows the states of four different substances, W, X, Y and Z, at different temperatures.

Substance	0°C	50°C	100°C
W	Liquid	Gas	Gas
X	Solid	Liquid	Liquid
Y	Solid	Liquid	Gas
Z	Solid	Solid	Liquid

Which of the following statements can be concluded?

- (1) Z is a solid at 60°C.
- (2) The boiling point of W is 50°C.
- (3) X has a lower freezing point than Z.
- (4) W has a higher boiling point than substance Y.

- 27 The following diagram shows the water cycle.

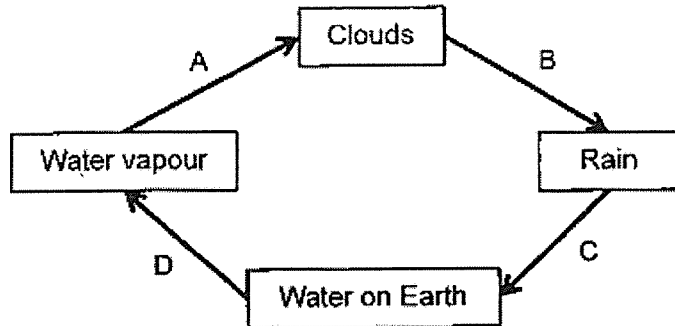

Change of state of water occurs at stage(s) \_\_\_\_\_.

- (1) B only
  - (2) A and D only
  - (3) B and C only
  - (4) D only
- 28 The diagram shows a mini water cycle set-up.

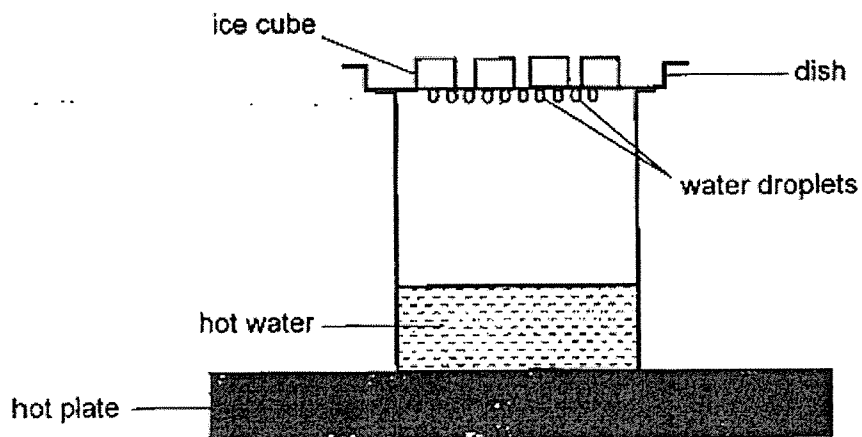

Which of the following is likely to be observed when more ice cubes are placed in the dish?

- (1) The ice will melt more quickly.
- (2) All the water droplets disappear.
- (3) Temperature of the hot water will increase.
- (4) More water droplets will form under the dish.

(Go on to Booklet B)



**Anglo-Chinese School  
(Primary)**

A Methodist Institution  
(Founded 1886)

**END OF YEAR EXAMINATION 2023  
SCIENCE  
PRIMARY FIVE  
BOOKLET B**

Name: \_\_\_\_\_ (     )

Class: Primary 5 \_\_\_\_\_

Date: 26 October 2023

Total Time for Booklets A and B: 1 h 45 min

\_\_\_\_\_  
Parent's/ Guardian's signature

**INSTRUCTIONS TO CANDIDATES**

1. Write your name, register number and class in the spaces provided.
2. Do not turn over this page until you are told to do so.
3. Follow all instructions carefully.
4. Answer all questions.
5. Write your answers in this booklet.

BOOKLET	MAX MARKS	MARKS OBTAINED
A	56	
B	44	
Total	100	

This booklet consists of 14 printed pages including this cover page.

For questions 29 to 41, write your answers in this booklet.

The number of marks available is shown in brackets [ ] at the end of each question or part question.

(44 marks)

- 29 The graph shows how the length of Ron's shadow changes over a period of time as he walks in a straight line near a street lamp at night.

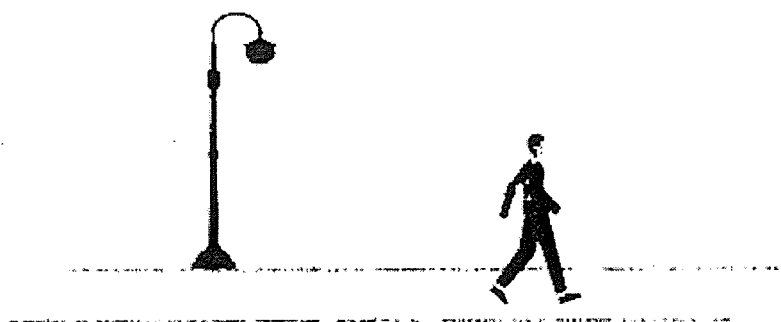

length of shadow (m)

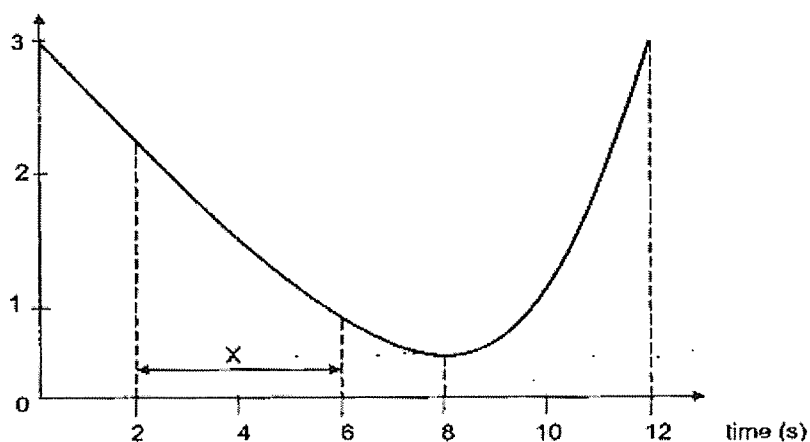

- (a) Explain how shadows are formed. [1]

---



---

- (b) Is Ron walking towards or away from the lamp during the period X shown in the graph? Give a reason for your answer. [1]

---



---

- (c) At what time was Ron nearest to the street lamp? Explain your answer. [1]

---



---

(Go on to the next page)

Score	3
-------	---

- 30 Sam conducted the following experiment as shown in the diagram. He hung a 10 g load from String A.

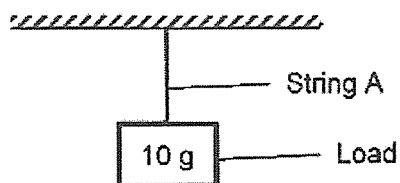

He increased the mass of the load until String A broke. He then repeated the experiment with strings, B and C. The maximum mass of the load that the strings could hold before breaking was recorded in the table.

String	A	B	C
Maximum mass of load before string broke (g)	40	70	30

- (a) Based on the above information, which property of the material is Sam testing? [1]

- (b) Sam conducted another experiment by rearranging the strings and loads as shown in the diagram.

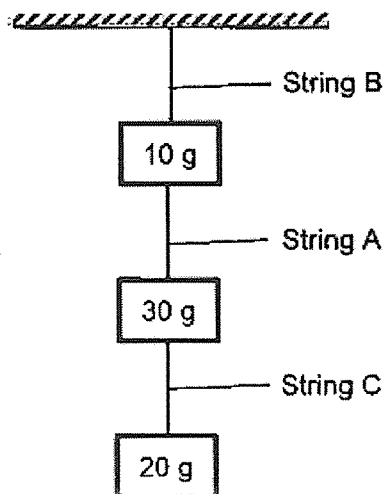

Based on the results above, which string, A, B or C, would break? Explain your answer.

[2]

(Go on to the next page)

Score	3
-------	---

31 Nate has a tractor with an attached toy cart as shown.

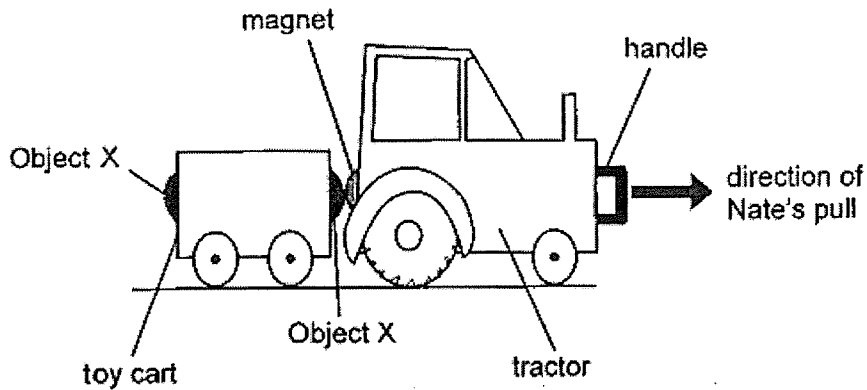

The tractor has a magnet at each end. The cart also has an object, X, attached at each end. When Nate pulls the tractor, the cart moves along with it.

- (a) When Nate pulls the tractor, the toy cart moves along with the tractor. Explain why. [2]

---



---

- (b) After dropping the tractor many times, Nate observed that the toy cart no longer moved when he pulled the tractor. Explain why this was so. [1]

---



---

(Go on to the next page)

Score	3
-------	---

32 The diagram shows the human digestive system.

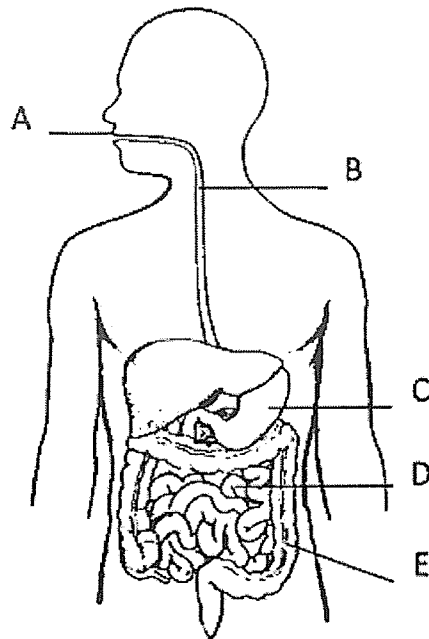

- (a) Which of the above part(s), A, B, C, D or E, produce digestive juices? [1]

---

- (b) State the function of part E. [1]

---



---

Eggs of organism Z enter the human body when undercooked food is eaten. The eggs hatch and grow into adults which are found attached to part D. The diagram shows part D infected with organism Z. Z does not feed directly on the food present in part D.



- (c) Explain why a person having organism Z in his body will get less digested food. [2]

---



---

(Go on to the next page)

Score	4
-------	---

- 33 The bar graph shows the amount of blood from the heart that will flow to the various parts of the body when a person is at rest and running.

Amount of blood  
flowing from heart  
to body parts

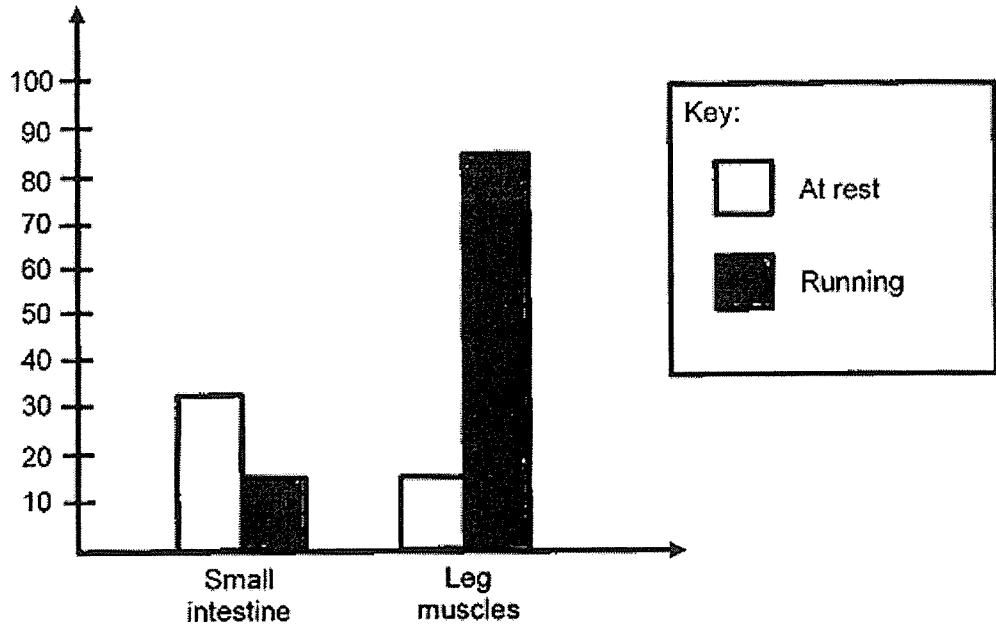

- (a) Explain why the blood flow to the muscles is higher when a person is running than when he is resting. [2]

---



---



---



---

- (b) Alfred decided to exercise immediately after a heavy meal. Based on the graph shown above, explain why he should not exercise after eating. [1]

---



---

(Go on to the next page)

Score	3
-------	---



- 34 Kevin designs an automatic food dispenser as shown to help him feed his dog. When the food tray is empty, the iron rod interacts with object X. This causes X to slide away so that food will drop from the dispenser to fill the food tray.

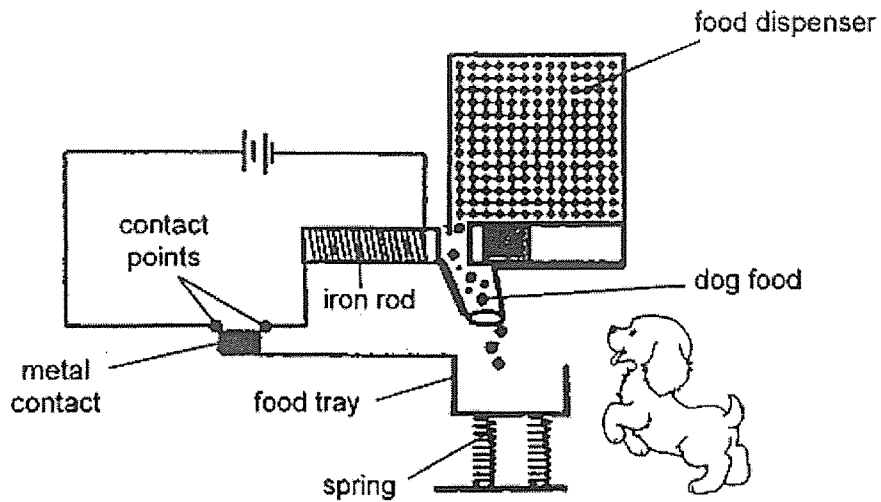

When the food tray is filled, the food tray moves down and object X moves back to close the opening, so food will stop dropping into the tray as shown.

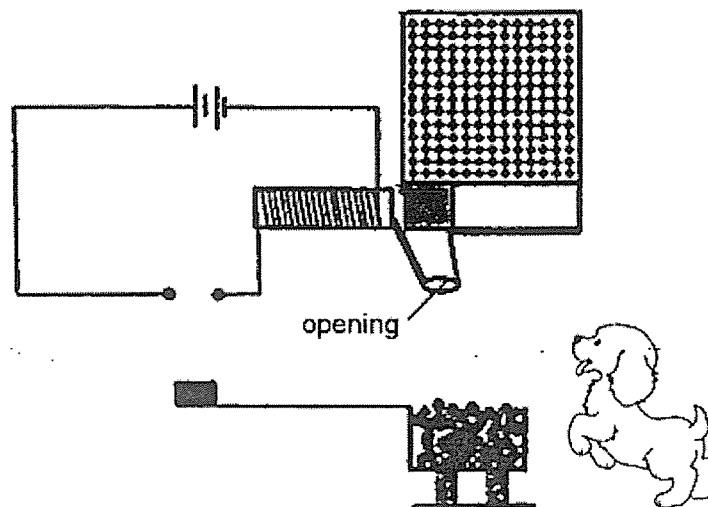

- (a) Based on the observation above, explain why object X is able to slide away to allow food to drop into the tray when it is empty. [2]

---



---

- (b) Using the same food tray and springs, what change can Kevin make to the set-up so that the food tray will be filled slower? [1]

---



---

(Go on to the next page)

Score	3
-------	---

- 35 In an experiment, four similar cells were placed separately into each set-up, A, B, C and D, containing different liquids. The observations were recorded in the table below.

Set-Up	Liquids	Observations
A	water	The cell swelled.
B	yellow liquid (yellow dye and water)	The cell swelled and turned yellow.
C	green liquid (green dye and water)	The cell swelled and no change in the colour of the cell.
D	mixture of yellow and green liquids	?

- (a) Which part of the cell in set-up B allows it to swell and turn yellow? [1]

---

- (b) What would the observations of the cell in set-up D be? Give a reason. [2]

---



---

- 36 The diagram below shows process C in human reproduction.

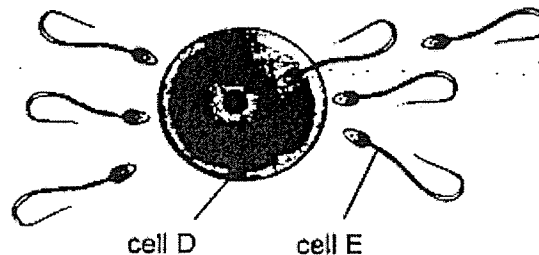

Process C

- (a) Name the organs that produce cells D and E. [1]

(i) Cell D: \_\_\_\_\_

(ii) Cell E: \_\_\_\_\_

- (b) Name Process C and describe the process. [1]

---



---

(Go on to the next page)

Score	5
-------	---

37 Observe flower A.

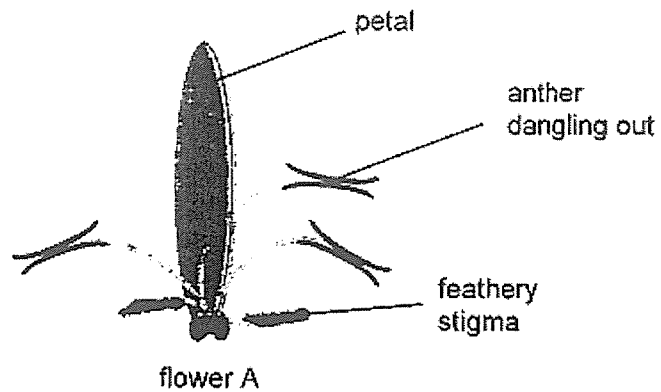

(a)(i) State the method of pollination for flower A. [1]

---

(ii) Based on the characteristics of the stigma and anther shown, give a reason for the method of pollination given in (a)(i). [1]

---



---

(b) The maps below show the locations of two types of plants, B and C, on an island from the year 2019 to 2022.

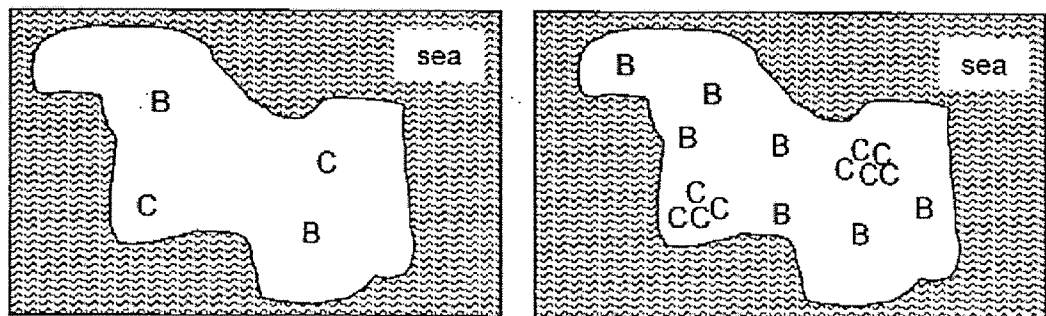

in 2019

in 2022

The young plants of B are observed to be healthier than those of C.

Based on the maps, explain why the young plants of B are healthier. [2]

---



---



---



---

(Go on to the next page)

Score	4
-------	---

38 Henry observed the seeds of fruit K.

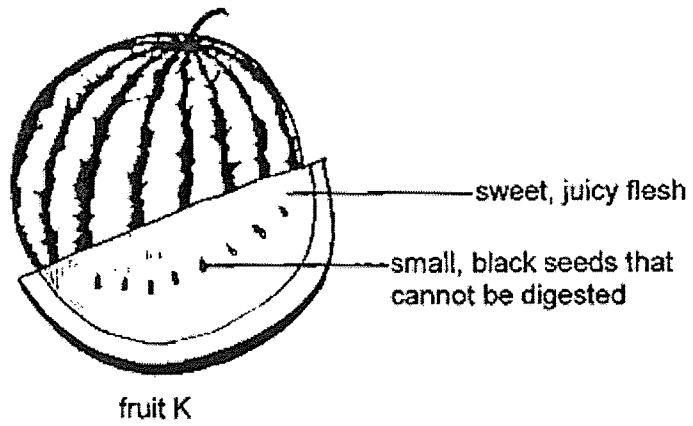

(a) Describe how the characteristics of fruit K helps in its dispersal. [1]

---



---

(b) After a few days, Henry observed that the seed undergoes Process Z.

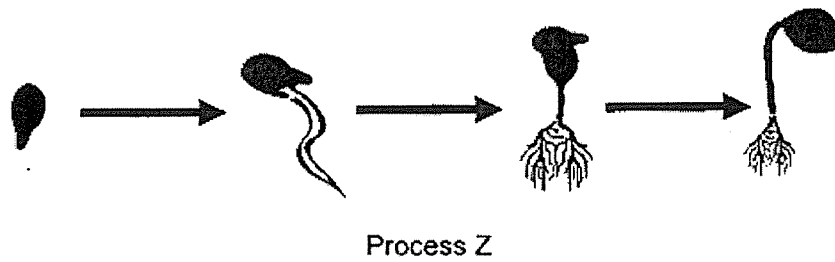

(i) What is Process Z? [1]

---

(ii) State the conditions needed for process Z to take place. [1]

---



---

- (c) Henry wants to investigate if the presence of light will affect process Z. He only has the following items shown below which he may use some or all of them.

Item	Number
red bean seed	10
wet cotton wool	4
table lamp	2

He placed two identical beakers in a dark room for his investigation.

In the table below, state the number of each item he should use for each set-up. [2]

	Item	Number
<b>Experimental set-up</b>	red bean seed	
	wet cotton wool	
	table lamp	
<b>Control set-up</b>	red bean seed	
	wet cotton wool	
	table lamp	

(Go on to the next page)

Score	5
-------	---

39 The graph shows the temperature of a farm across several hours.

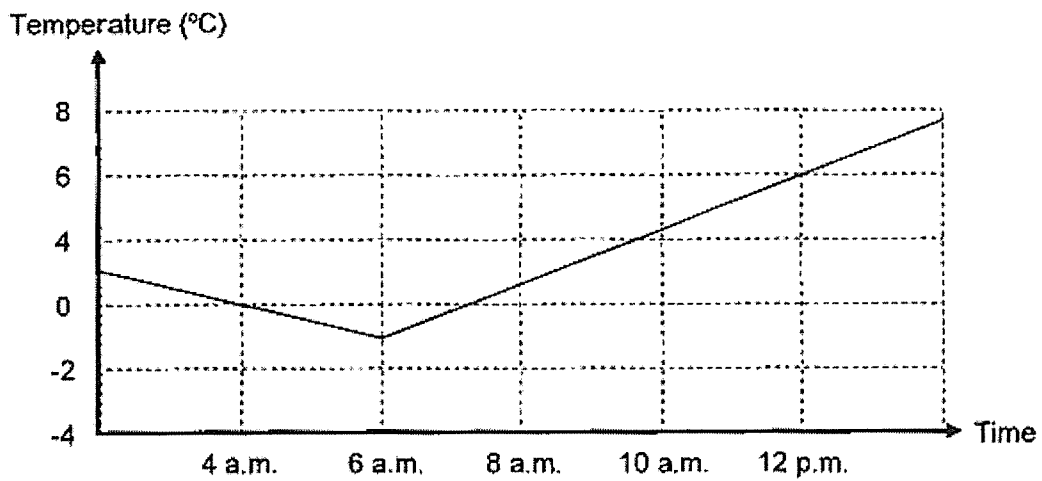

Jane observed that some white solids could be seen on the surface of the leaves at about 6 a.m.

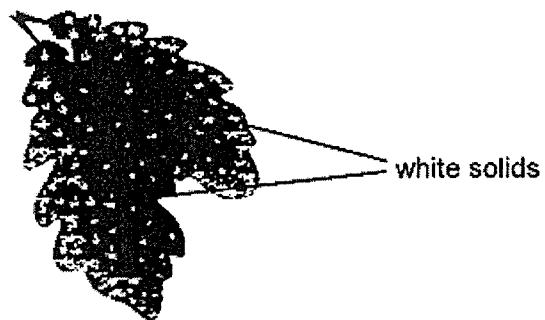

(a) Explain how the white solid formed. [2]

---



---



---

(b) When Jane returned to observe the leaves at 10 a.m., the white solids could no longer be seen. Explain why. [1]

---



---

(c) From the graph, what is the temperature of the farm at 12 p.m.? [1]

---

(Go on to the next page)

Score	4
-------	---

- 40 Xueli soaked four identical shirts, W, X, Y and Z, in the same amount of water before hanging them to dry under different conditions. She then measured and recorded the mass of the shirts after 6 hours.

Shirt	Conditions	Mass of shirt after 6 hours (g)
W	unfolded and hung in the sun	100
X	folded in half and hung in the sun	150
Y	folded in half and hung in the shade	200
Z	folded to one-third its actual size and hung in the shade	300

- (a) Xueli compared the mass of shirts W and X after 6 hours. Explain the difference in their masses.

[2]

---



---



---

- (b) Xueli wanted to investigate the effects of temperature on the mass of the shirts. Which two shirts should she use? Explain your answer.

[1]

---



---



---

Score	3
-------	---

41 After a long and hot day of hiking, a group of students set up the system below to collect drinkable water. After a few hours, some water is collected in the container.

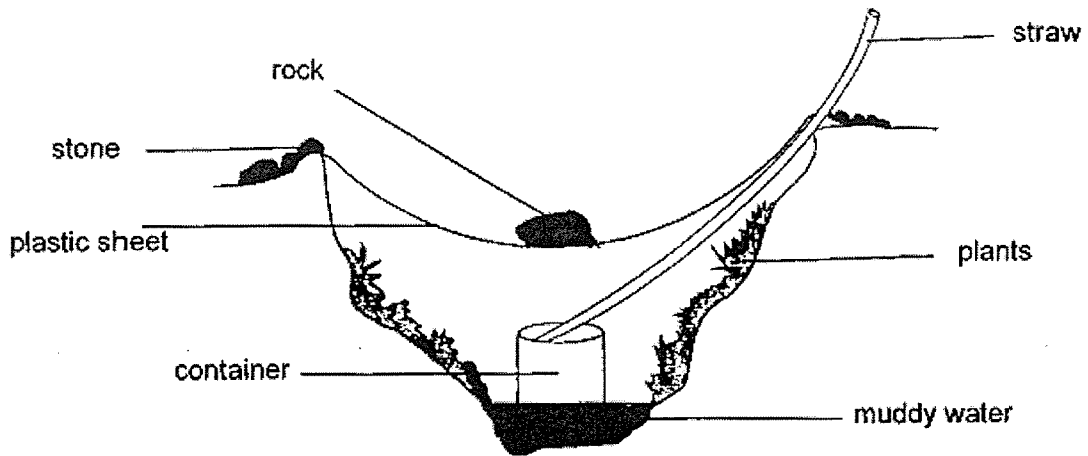

(a) Draw in the above diagram a possible observation the students can make at the plastic sheet. [1]

(b) Explain how drinkable water is collected in the container. [2]

---



---



---



---

(c) Suggest how the presence of plants affect the amount of water collected. [1]

---



---

- End of Booklet B -

Score	4
-------	---



Name : \_\_\_\_\_ ( )

Class : P5 \_\_\_\_\_

**ACS(P) 2023 EYE P5 Science Correction Template**

No	Ans	No	Ans	No	Ans	No	Ans	No	Ans	No	Ans
1	4	6	1	11	2	16	1	21	3	26	3
2	1	7	3	12	1	17	4	22	2	27	2
3	4	8	2	13	2	18	3	23	3	28	4
4	1	9	4	14	3	19	2	24	4		
5	2	10	1	15	4	20	1	25	4		

QN.	ACCEPTABLE RESPONSES	MARKS
29a	When light is <u>blocked</u> by an object, a shadow is formed.	1
29b	He is walking <u>towards</u> the lamp, as the length of his shadow <u>decreases</u> .	1
29c	8 seconds. His shadow is <u>shortest</u> when he is nearest to the streetlamp like at 8 seconds.	1
30a	Strength of the material / how <u>strong</u> the material is	1
30b	String A  The total mass of load which String A was holding at 50g exceeded its <u>maximum</u> load of 40g.	2
31a	The magnet (on the tractor) <u>attract</u> Object X, a magnetic material/ magnet, so the cart moves along when Nate pulls the tractor.	2
31b	The magnet has lost its <u>magnetisms</u> / magnetic force. OR The magnet has become weaker.	1
32a	A, C, D	1
32b	To absorb/remove <u>water</u> (and minerals) from the <u>undigested</u> food.	1
32c	When the digested food is <u>absorbed</u> by the intestine, some of it will get <u>eaten</u> by Z.	2

33a	The heart pumps blood <u>faster</u> to ensure that <u>more</u> digested food and oxygen is transported to the muscles so that <u>more</u> energy can be released for respiration/ the muscles to work.	2
33b	When exercising, <u>less</u> blood flowing to the <u>small intestine</u> causes less digested food to be absorbed.  OR  When exercising, <u>more</u> blood will flow to the <u>muscle</u> instead of the stomach and small intestine, so lesser digested food is absorbed.	1
34a	The metal contact touches the contact points, <u>closing</u> the circuit so current flows and <u>magnetises</u> the iron rod.  <u>Like</u> poles of X and electromagnet face each other, causing them to <u>repel</u> .  X slides away, allowing food to drop into the tray.	2
34b	Kevin should use less <u>batteries</u> in the set-up. OR  He should have less <u>coils</u> around the iron rod.	1
35a	Cell membrane	1
35b	The cell will <u>swell</u> and turn <u>yellow</u> .  The cell membrane allowed <u>only</u> the yellow dye and water to <u>enter</u> the cell.	2
36a	(i) Ovary / ovaries  (ii) Testes / testis	1
36b	Fertilisation. The male and female reproductive cells will <u>fuse</u> together.	1
37a	(i) By <u>wind</u>  (ii) The anther is <u>hanging</u> out so that the pollens can be <u>blown</u> away by the wind easily. OR	1  1

	The stigma is <u>feathery</u> so that it can <u>capture</u> the pollen grains blown by the wind.																		
37b	Plant B are healthier as the seeds were dispersed <u>further</u> away from each other, so there is less <u>competition</u> for sunlight, water, mineral salts and space [at least 3 factors must be mentioned].	2																	
38a	The sweet/juicy <u>flesh</u> attracted animals to eat the fruit and the seeds would then be passed out in their <u>dropping</u> be spit out.	1																	
38b	(i) Germination	1																	
	(ii) Water, oxygen / air and warmth / suitable temperature	1																	
38c	<table border="1" style="margin-left: auto; margin-right: auto;"> <thead> <tr> <th></th> <th>Item</th> <th>Number</th> </tr> </thead> <tbody> <tr> <td rowspan="3" style="text-align: center;">Experimental set-up</td> <td>red bean seed</td> <td>5</td> </tr> <tr> <td>wet cotton wool</td> <td>1 (or 2)</td> </tr> <tr> <td>table lamp</td> <td>1 (or 2)</td> </tr> <tr> <td rowspan="3" style="text-align: center;">Control set-up</td> <td>red bean seed</td> <td>5</td> </tr> <tr> <td>wet cotton wool</td> <td>1 (or 2)</td> </tr> <tr> <td>table lamp</td> <td>0</td> </tr> </tbody> </table>		Item	Number	Experimental set-up	red bean seed	5	wet cotton wool	1 (or 2)	table lamp	1 (or 2)	Control set-up	red bean seed	5	wet cotton wool	1 (or 2)	table lamp	0	2
	Item	Number																	
Experimental set-up	red bean seed	5																	
	wet cotton wool	1 (or 2)																	
	table lamp	1 (or 2)																	
Control set-up	red bean seed	5																	
	wet cotton wool	1 (or 2)																	
	table lamp	0																	
39a	Water <u>vapour</u> in the surrounding air <u>lost</u> heat to the <u>colder</u> surface of the leaves and <u>condensed</u> to form water droplets. The water droplets then lost heat to the colder leaves and <u>freeze</u> to form ice/white solid.	2																	
39b	The white solid <u>gained</u> heat from the warmer surrounding air and <u>melted</u> to form water.	1																	
39c	6°C	1																	

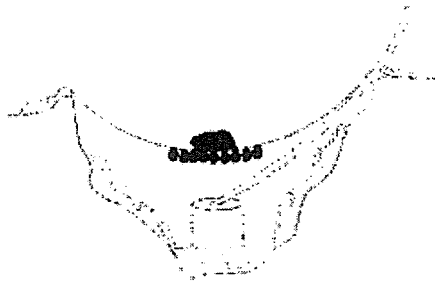
40a	X had a smaller <u>exposed</u> surface area than W, causing <u>less</u> water to evaporate / a slower rate of evaporation.	2
40b	She should use X and Y. The only changed variable is the location, which are at different <u>temperatures</u> .	1
41a	The tiny water droplets are formed on the <u>underside</u> of the plastic sheet.  	1
41b	The muddy water <u>gains</u> heat from the warmer surroundings and evaporates into water vapour. The water vapour touches the <u>cooler</u> plastic sheet and <u>loses</u> heat, condensing into water droplets. The water droplets move towards the centre of the plastic sheet and fall/drop into the container.	2
41c	Plants give off water vapour. <u>More</u> water vapour results in more <u>condensation</u> so more water droplets are formed and collected.	1