



Nan Hua Primary School
Primary 4 Science
Term 3 Weighted Assessment 2023

Marks	
Section A:	/10
Section B:	/10
Total:	/20

Name: _____ ()

Class: Primary 4/ _____

Date: _____

Duration: 30 minutes

Parent's Signature _____

Answer all questions.

Section A: (5 x 2 marks = 10 marks)

For each question from 1 to 5, four options are given. One of them is the correct answer. Make your choice (1, 2, 3 or 4) and write your answer in the brackets provided.

1 Study the diagram of a measuring cylinder below.

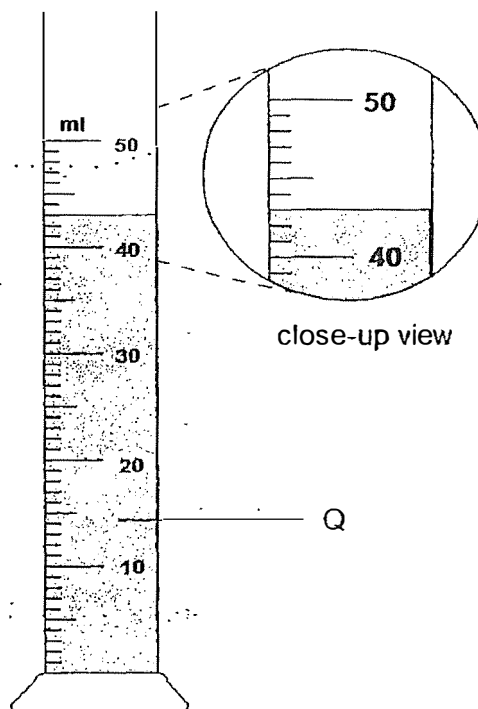

What is the volume of liquid Q?

- (1) 40 ml
- (2) 42 ml
- (3) 43 ml
- (4) 47 ml

()

- 2 The diagram below shows an air-tight container with a capacity of 500 cm^3 . 200 cm^3 of water had been poured into the container.

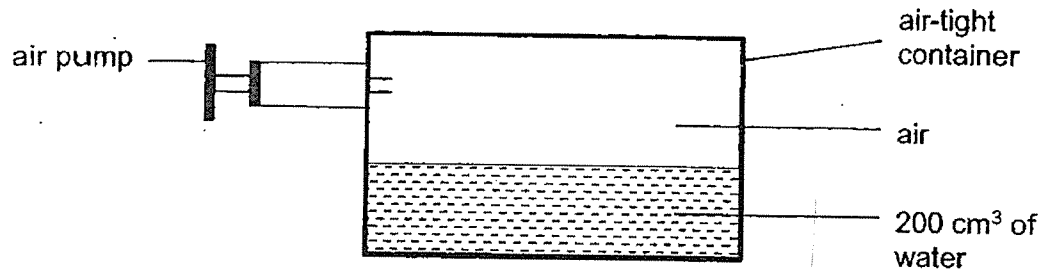

An additional 50 cm^3 of air was later pumped into the container using an air pump. Which of the following shows the final volume of air in the air-tight container and the change to the total mass of the air-tight container?

	Final volume of air (cm^3)	Total mass
(1)	300	increases
(2)	350	remains the same
(3)	350	increases
(4)	500	remains the same

()

3 Which of the following is **not** a source of heat energy?

(1)

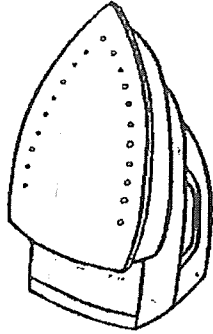

iron (switched on)

(2)

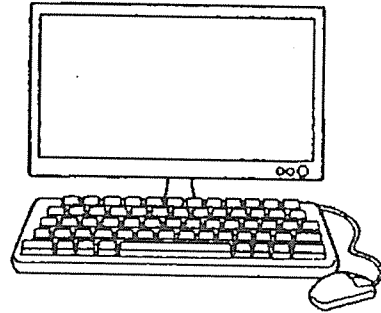

computer (switched on)

(3)



a campfire

(4)

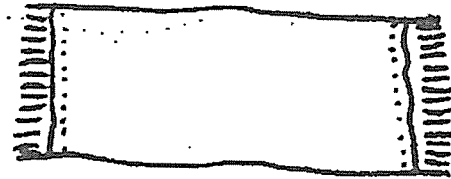

a towel

(:)

- 4 Alex's fingers feel cold when he touches the spoon placed in a cup of ice water.

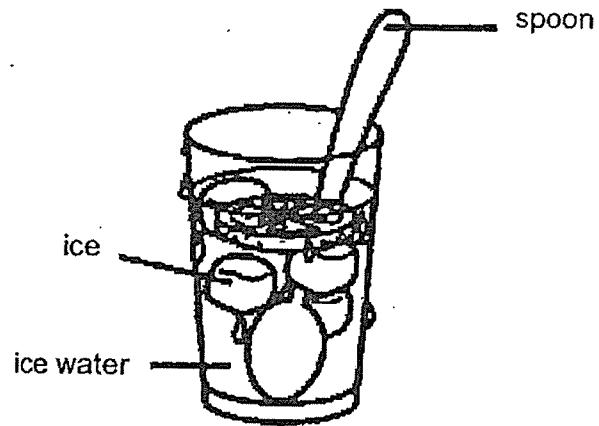

Which of the following statements is correct?

- (1) Coldness travels from the ice to the spoon.
- (2) Coldness travels from the spoon to his fingers.
- (3) Heat travels from the water to his fingers through the spoon.
- (4) Heat travels from his fingers to the water through the spoon.

()

- 5 In the set-up below, a drop of red ink is placed in the middle of the glass tube connecting the two identical flasks, X and Y.

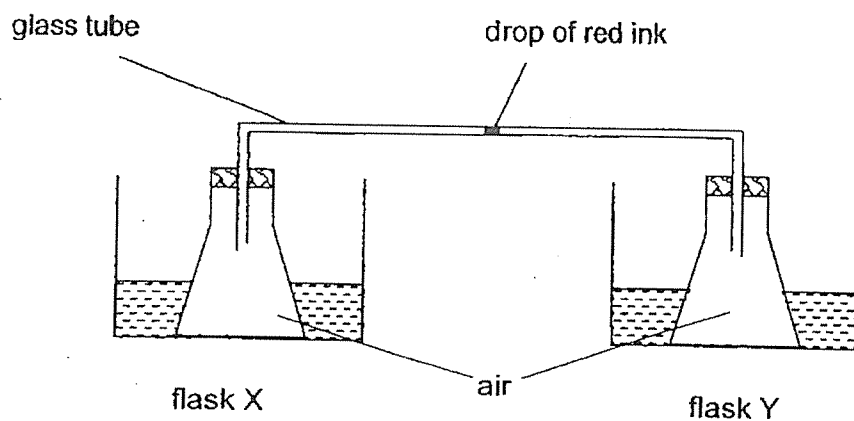

Each flask is then placed in a basin of water. Which arrangement will make the drop of red ink move the closest to flask X?

	Place flask X in a basin of	Place flask Y in a basin of
(1)	ice water	water at room temperature
(2)	water at 95 °C	ice water
(3)	water at room temperature	ice water
(4)	ice water	water at 95 °C

()

(Go on to the next page)

Total score for Section A	10
------------------------------	----

Section B: Structured questions (10m)

For questions 6 to 8, write your answers in the space provided. The number of marks available is shown in brackets [] at the end of each question or part question.

- 6 David carried out the following experiment in the kitchen which had a room temperature of 30 °C. He filled containers P and Q with different amounts of water at 80 °C. He wanted to find out in which container, P or Q, would an egg be cooked more quickly.

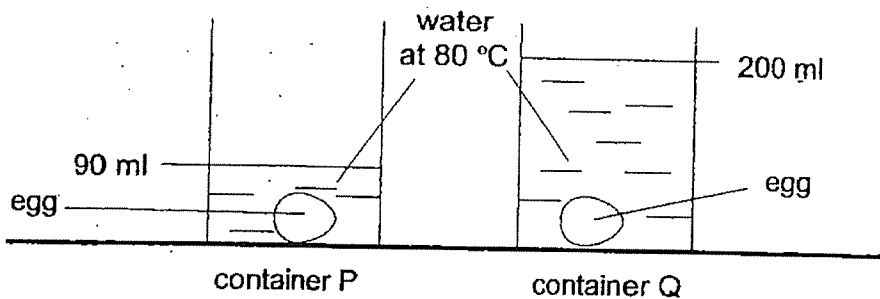

- (a) What is the changed (independent) variable in this experiment? [1]

- (b) If both eggs were left in the containers for 10 minutes, in which container, P or Q, would the egg be cooked more quickly? Explain your answer. [2]

- (c) The above set-up was left untouched in the kitchen. What would happen to the temperature of the water in containers P and Q after one day? [1]

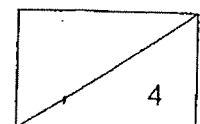

- 7 Two cups were found stuck to each other in Mrs Raju's cupboard. She added some ice cubes to cup B as shown in the diagram below.

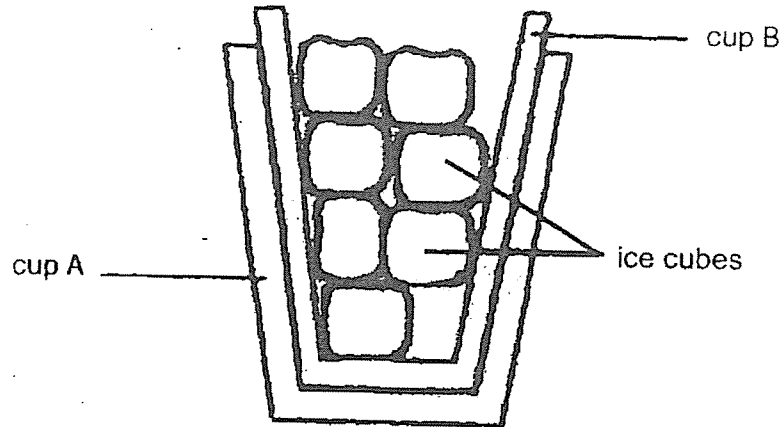

- (a) Fill in the blanks with the correct words.

After a while, Mrs Raju found it easier to remove the two cups from each other.

Cup B _____ heat to the ice cubes and _____, making it easier for her to remove the two cups from each other. [1]

- (b) A metal bridge has gaps at its ends as shown below.

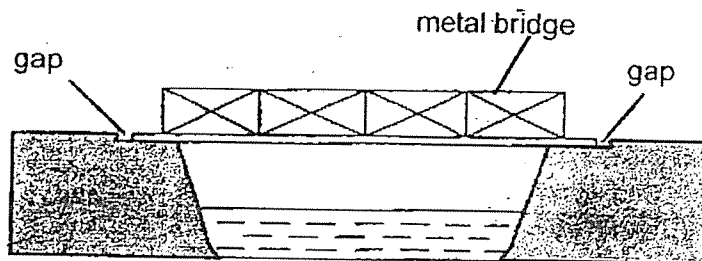

Explain how the gaps help to prevent the bridge from bending on a very hot day. [2]

- 8 Ali poured sand into a toy submarine and dropped it into a container of water as shown in the diagram below. He measured the distance, d , from the bottom of the container to the base of the toy submarine.

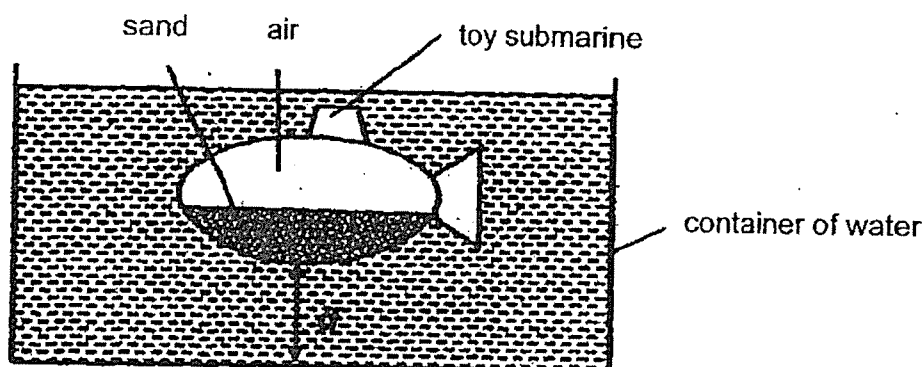

Ali repeated the experiment by pouring different amounts of sand into the toy submarine. He recorded the results of his experiment as shown in the table below.

Mass of sand in the toy submarine (g)	Distance d (cm)
10	25
20	20
30	15
40	10

- (a) What is the relationship between the mass of the sand and distance d ? [1]



Ali dropped the toy submarine on the floor and it cracked.

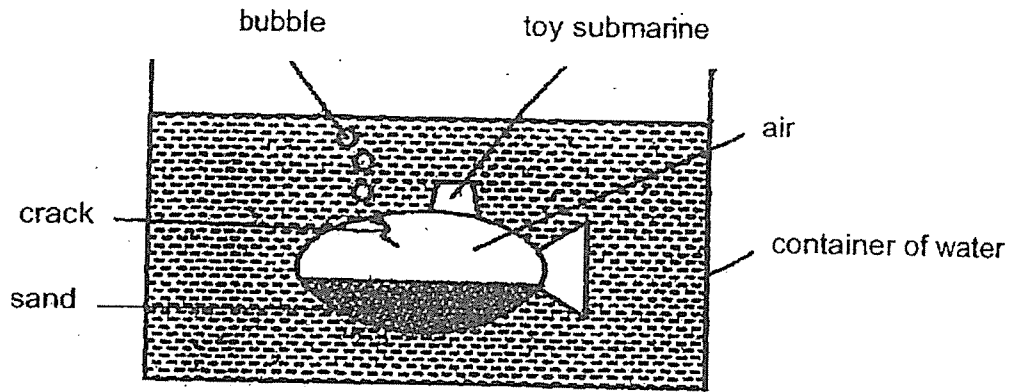

- (b) When he placed the toy submarine back into the water, he observed bubbles coming out from the crack. After some time, the toy submarine sank deeper. Explain why. [2]

End of Paper

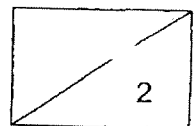

SCHOOL : NAN HUA PRIMARY SCHOOL
LEVEL : PRIMARY 4
SUBJECT : SCIENCE
TERM : WA2 2023

Q 1	Q2	Q3	Q4	Q5
3	1	4	4	4

Q6)	<p>a) The amount of water</p> <p>b) The egg will be cooked more quickly in container Q. This is because in container Q there is more water than container P. Since container Q has more water than container P, it means that there is more heat in container Q, so more heat will travel to the egg in container Q while in container P, there will be less heat to travel to the egg inside it. The egg with more heat will cook faster. So, the egg will be cooked more quickly in container Q.</p> <p>c) The temperature will decrease and it will have the same temperature as the room.</p>
Q7)	<p>a) Cup B lost heat to the ice cubes and contracted, making it easier for her to remove the two cups from each other.</p> <p>b) The gaps allow space for the metal bridge to expand when it gains heat from the warmer surroundings.</p>
Q8)	<p>a) As the mass of sand in the toy submarine increases, distance d decreases.</p> <p>b) As the bubbles coming out of the crack are the air inside the toy submarine that means that the air will be gone after some time. Since the air escaped from the toy submarine the water in the container will go through the crack and take up space that the air took water has more mass than air. So the toy submarine sank deeper.</p>

