

METHODIST GIRLS' SCHOOL  
Founded in 1887



PRIMARY 4  
SCIENCE  
WEIGHTED ASSESSMENT 1

Total Time for Paper: 40 min

INSTRUCTIONS TO CANDIDATES

Do not turn over this page until you are told to do so.  
Follow all instructions carefully.  
Answer all questions.

Name: \_\_\_\_\_ ( )

Class: Primary 4. \_\_\_\_\_

Date : \_\_\_\_\_

Parent's signature: \_\_\_\_\_

Section A	14
Section B	11
Total	25

This paper consists of 8 printed pages including this page.



**Section A**

For each question from 1 to 7, four options are given. One of them is the correct answer. Make your choice (1, 2, 3 or 4) and write in the bracket provided. [14 marks]

- 1 The diagram shows the life cycle of an animal.

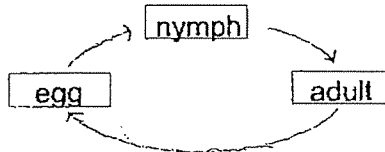

Which animal is likely to have the life cycle as shown above?

- (1) frog  
 (2) chicken  
 (3) butterfly  
 (4) grasshopper ( )

- 2 Which animal has the pupa stage in its life cycle?

- (1) frog  
 (2) chicken  
 (3) cockroach  
 (4) mealworm beetle ( )

- 3 Jason prepared four set-ups, J, K, L and M as shown in the table below.

Set-up	Type of seed	Number of seeds	Temperature (°C)	Time taken for roots to appear (days)
J	Seed W	10	40	8
K	Seed X	5	30	5
L	Seed W	10	30	7
M	Seed X	10	20	6

He wants to find out if temperature affects how fast the seeds grow. Which two set-ups should he use?

- (1) J and K  
 (2) J and L  
 (3) K and L  
 (4) K and M ( )

(Go on to the next page)

4 Study the flow chart below.

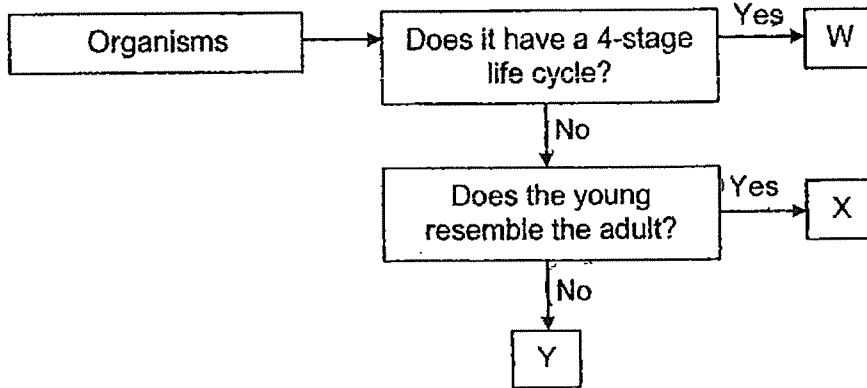

Which of the following represents organisms W, X and Y?

	W	X	Y
(1)	butterfly	frog	cockroach
(2)	butterfly	cockroach	frog
(3)	ladybird beetle	cockroach	mosquito
(4)	ladybird beetle	grasshopper	mosquito

5 The table below shows the characteristics of animals A and B.

Characteristics	Animal	
	A	B
Has a pupal stage	No	Yes
Has wings in adult stage	No	Yes
Gives birth to young alive	Yes	No

Based on the table above, which one of the following statements is correct?

- (1) Both animals can fly at their young stage.
- (2) The young of A looks different from the adult.
- (3) Animal A gives birth to young alive while animal B lays eggs.
- (4) Animal A has 4 stages in its life cycle while animal B has 3 stages in its life

( )

(Go on to the next page)

6 Four set-ups were placed in a room near the window as shown below.

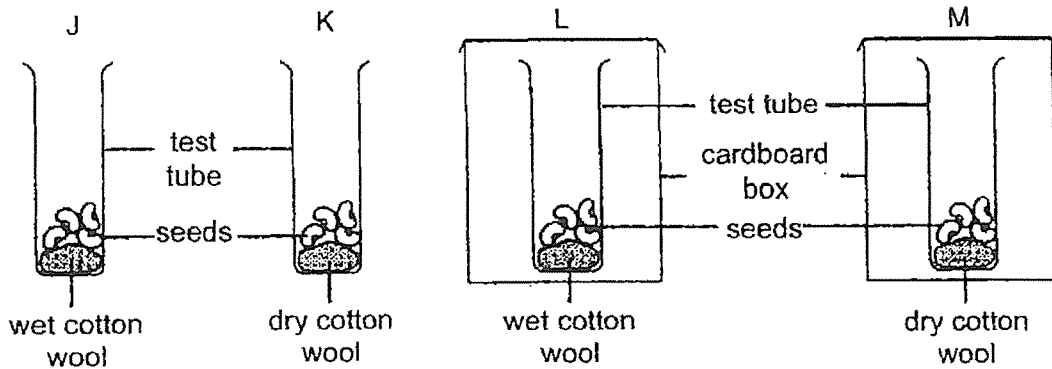

In which of the set-ups will the seeds not grow into young plants?

- (1) K and M
- (2) L and M
- (3) J, K and M
- (4) K, L and M

( )

7 The diagrams below show the life cycles of two different animals, S and T.

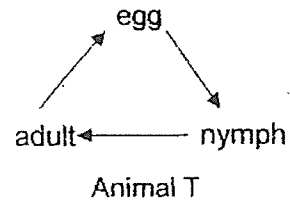
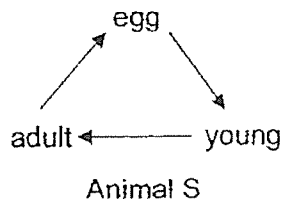

Both animals S and T have \_\_\_\_\_.

- A three stages in their life cycle.
- B young that look like the adults.
- C young that moults several time.
- D adults that have wings and can fly.

- (1) A only
- (2) B only
- (3) B and D only
- (4) C and D only

( )

(Go on to the next page)

**Section B**

For questions 8, 9 and 10, write your answers in the space provided.

[11 marks]

8 The diagram below shows the life cycle of a frog.

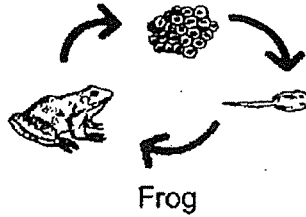

(a) Which two characteristics of living things are shown in the life cycle of the frog? [1]

(i) \_\_\_\_\_

(ii) \_\_\_\_\_

(b) State one difference between the number of stages in the life cycles of a frog and a butterfly. [1]

\_\_\_\_\_  
\_\_\_\_\_

(c) State one similarity between the life cycles of a frog and a butterfly. [1]

\_\_\_\_\_  
\_\_\_\_\_

(d) Explain why it is important for the frog to lay many eggs. [1]

\_\_\_\_\_  
\_\_\_\_\_

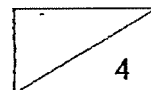

(Go on to the next page)

- 9 Salim wanted to find out how the temperature of the surroundings affects the growth plants. He set up three containers with similar plants. He planted them in equal amounts of soil and water them with the same amount of water daily as shown below.

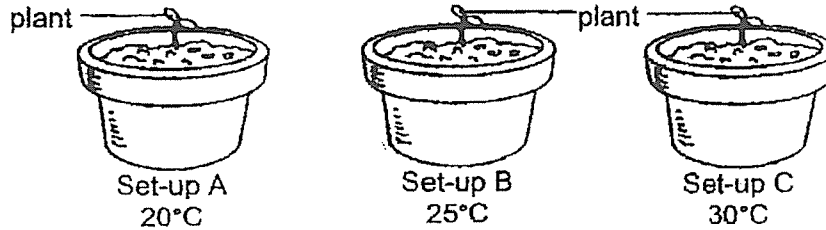

He recorded his observations after 1 week as shown in the table below.

Set-up	A	B	C
Temperature of the surroundings ( $^{\circ}\text{C}$ )	20	25	30
Height of plant at the start (cm)	5	5	5
Height of plant at the end (cm)	9	16	23

- (a) State the variable Salim should change in the experiment. [1]

---



---

- (b) State how the height of the plant changed when the temperature of the surrounding increased. [1]

---



---

- (c) Which temperature is the least suitable for the growth of the plants? Explain your answer based on Salim's observations. [1]

---



---

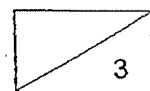

(Go on to the next page)

10 Study the life cycle of a mosquito below.

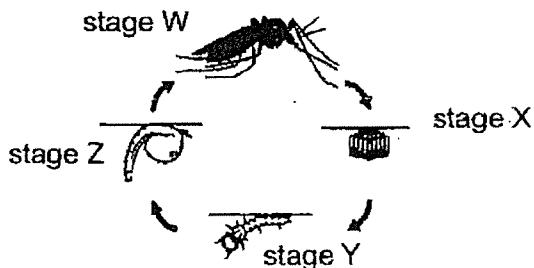

(a) Name stage Z of the life cycle of the mosquito. [1]

Stage Z: \_\_\_\_\_

Study the flow chart below.

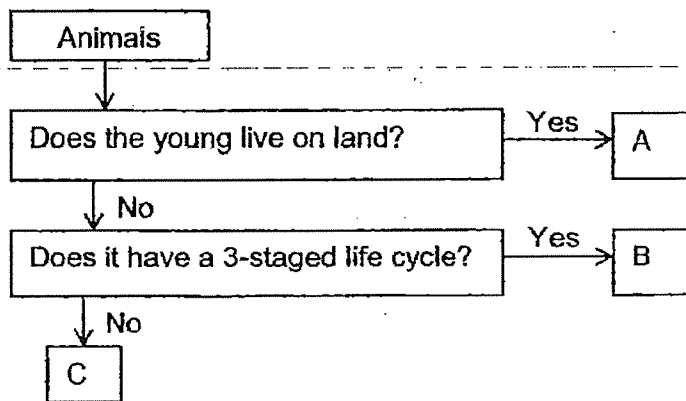

(b) Which letter A, B or C represents the mosquito? [1]

\_\_\_\_\_

(c) State two characteristics of the mosquito at stage Y that help it to grow into stage Z. [1]

\_\_\_\_\_

\_\_\_\_\_



The Aedes mosquito spreads dengue fever in humans. Water is often collected on the plates of flower pots.

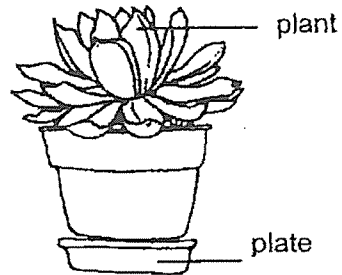

- (d) Based on the life cycle of a mosquito, explain why it is important to empty the water collected in the plate. [1]

---

---

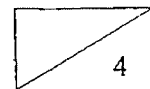



METHODIST GIRLS' SCHOOL  
Founded in 1887



PRIMARY 4  
SCIENCE  
WEIGHTED ASSESSMENT 2 2023

Total Time for Paper: 45 min

INSTRUCTIONS TO CANDIDATES

Do not turn over this page until you are told to do so.

Follow all instructions carefully.

Answer all questions.

Name: \_\_\_\_\_ ( )

Class: Primary 4. \_\_\_\_\_

Date : \_\_\_\_\_

Parent's signature: \_\_\_\_\_

Section A	18
Section B	12
Total	30

This paper consists of 11 printed pages including this page.

**Section A**

For each question from 1 to 9, four options are given. One of them is the correct answer. Make your choice (1, 2, 3 or 4) and write in the bracket provided. [18 marks]

1 Which of the following is matter?

- A Oil
- B Music
- C Cloud
- D Shadow

- (1) A only
- (2) A and C only
- (3) B and D only
- (4) A, B, and C only

( )

2 The classification chart below shows how different states of matter are grouped.

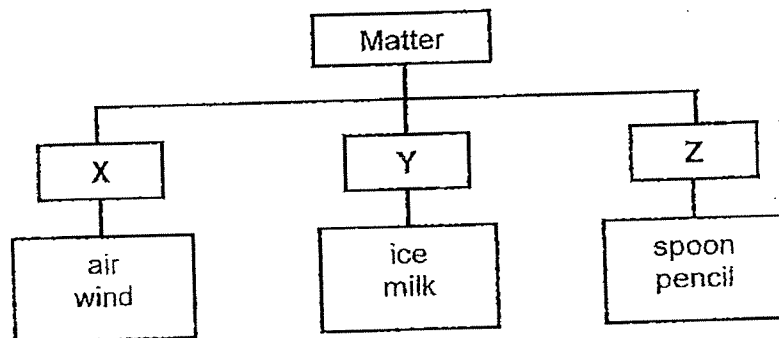

Which of the following is **wrongly** grouped?

- (1) Ice
- (2) Milk
- (3) Wind
- (4) Spoon

( )

(Go on to the next page)

- 3 Tom placed object X into a measuring cylinder. He then added some water and placed objects Y and Z into the measuring cylinder, as shown below.

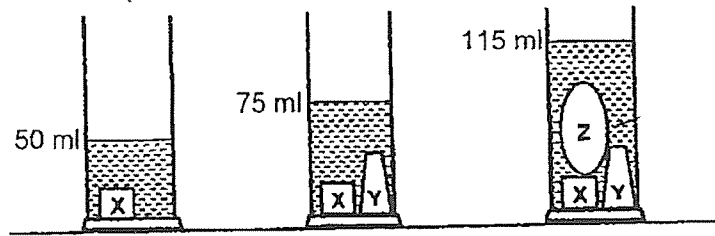

Based only on the information above, which of the following statements are true?

- A Tom can find the volume of water.  
 B Tom can find the volume of object X.  
 C Tom can find the volume of object Y.  
 D Tom can find the volume of object Z.

- (1) C and D only  
 (2) A, B and D only  
 (3) B, C and D only  
 (4) A, B, C and D

( )

- 4 Two objects made of the same material, X and Y, are placed on a lever balance as shown below.

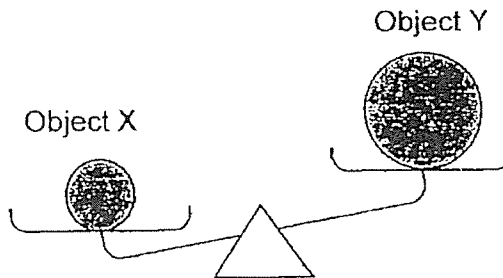

Which of the following statements are true?

- A Object X has a smaller mass than object Y.  
 B Object Y has a smaller mass than object X.  
 C Object X has a greater volume than object Y.  
 D Object Y has a greater volume than object X.

- (1) A and C only  
 (2) A and D only  
 (3) B and C only  
 (4) B and D only

( )

(Go on to the next page)

- 5 Study the set-up. The volume of the flask in the set-up below is  $500 \text{ cm}^3$ .

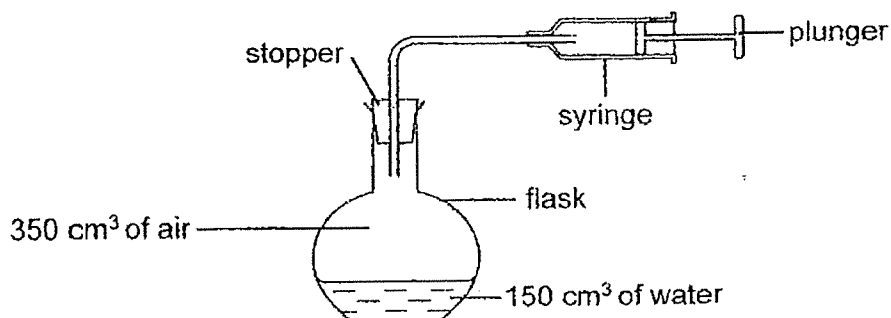

Using the syringe,  $50 \text{ cm}^3$  of water and  $100 \text{ cm}^3$  of air are added into the flask. What would be the final volume of air in the flask?

- (1)  $200 \text{ cm}^3$   
 (2)  $300 \text{ cm}^3$   
 (3)  $350 \text{ cm}^3$   
 (4)  $450 \text{ cm}^3$

( )

- 6 The diagram below shows a glass jar with a volume of  $600 \text{ cm}^3$ .

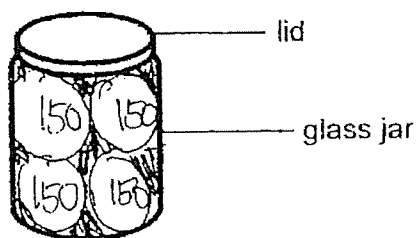

Which of the following can occupy the space in the glass jar with the lid on?

- P Pour in  $580 \text{ cm}^3$  of water  
 Q Pump in  $650 \text{ cm}^3$  of oxygen  
 R Put in four wooden balls each with a volume of  $150 \text{ cm}^3$

- (1) P and Q only  
 (2) P and R only  
 (3) Q and R only  
 (4) P, Q and R

( )

(Go on to the next page)

7 Study the flow chart below.

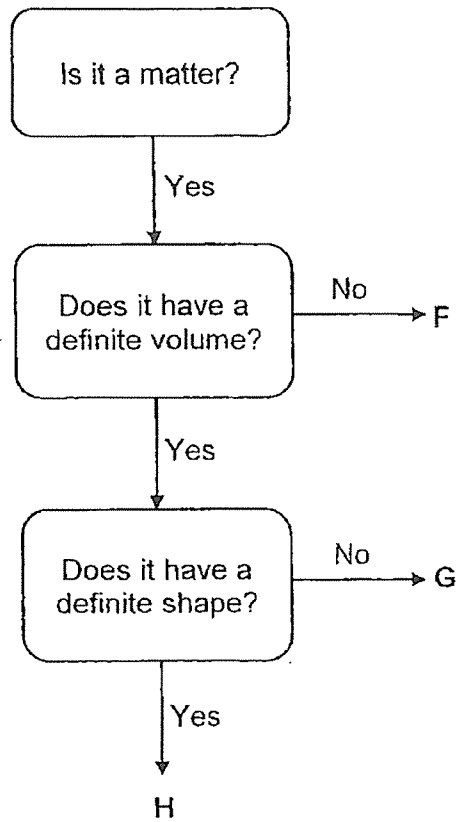

Which of the following correctly represents F, G and H?

	F	G	H
(1)	juice	air	marble
(2)	marble	juice	air
(3)	air	juice	marble
(4)	air	marble	juice

(Go on to the next page)

- 8 Bob filled a container with water and placed a piece of cork on the water as shown below.

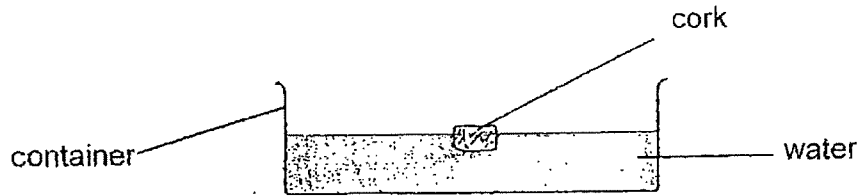

Which one of the following shows the most likely observation when he inverted an empty glass over the cork?

(1)

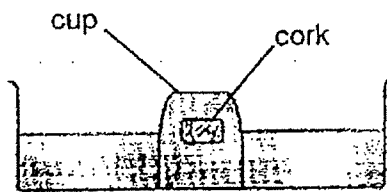

(2)

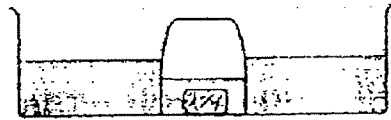

(3)

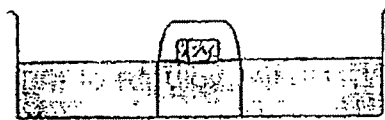

(4)

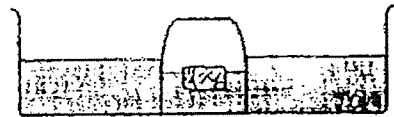

(Go on to the next page)



- 9 Study the set-up below. The volume of the container is  $400 \text{ cm}^3$ .  $100 \text{ cm}^3$  of air can be pumped out of the container each time.

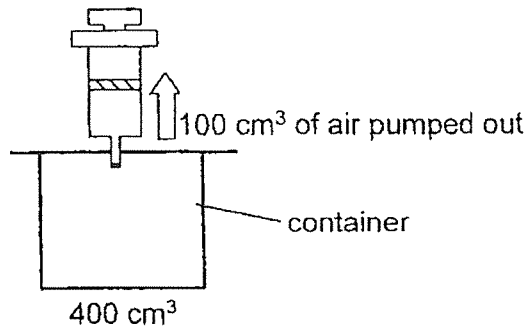

Which bar graph correctly shows the volume of air in the container if the air was pumped out of the container for three times?

(1)

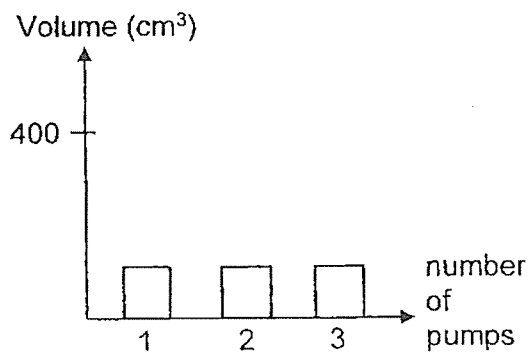

(2)

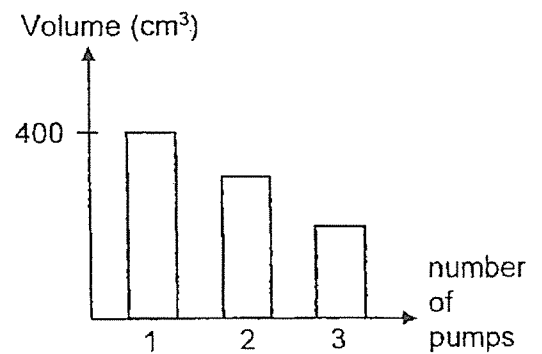

(3)

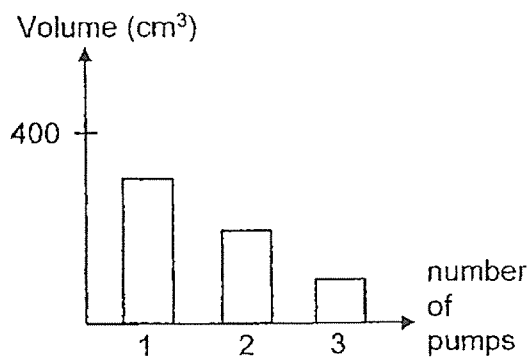

(4)

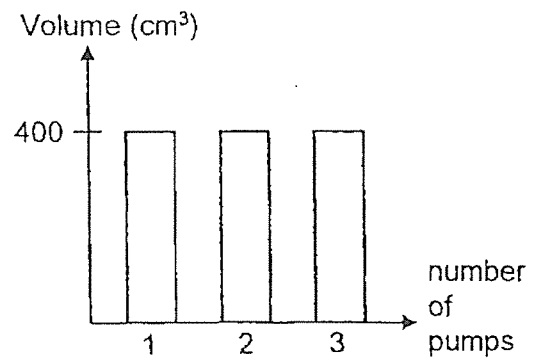

(Go on to the next page)

**Section B**

For questions 10 to 13, write your answers in the space provided.

[12 marks]

- 10 Fatimah put substance P into the syringe and observed whether the plunger could be pushed in when one end of the syringe is covered with her finger, as shown in the diagram below. She then repeated the experiment with substance Q which takes the shape of the syringe.

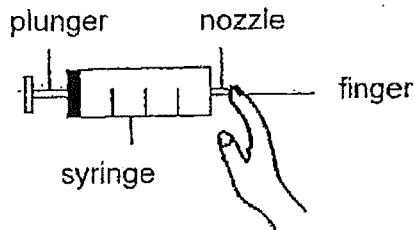

The plunger could be pushed in easily for substance P but could not be pushed in at all for substance Q.

- (a) Identify the states of matter for substances P and Q respectively. [1]

Substance P: \_\_\_\_\_

Substance Q: \_\_\_\_\_

- (b) Explain your answer in (a). [1]

\_\_\_\_\_

\_\_\_\_\_

\_\_\_\_\_

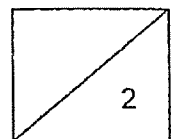

(Go on to the next page)

- 11 Joshua set up an experiment as shown in the diagram below. He filled the tank with water to the brim. Then, he blew air through the straw into the balloon.

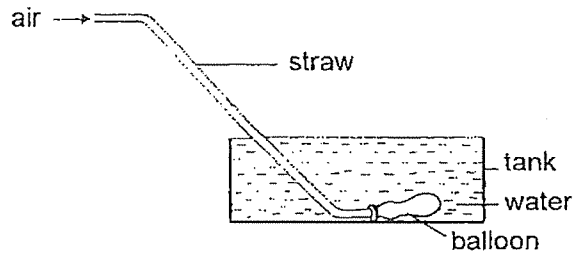

- (a) What would happen to the water in the container after he blew air into the straw? Explain your answer [2]

---



---



---

In another experiment, Joshua used a bottle to build a self-filling water bottle for his pet dog. He filled the bottle with water and inverted the bottle over a water bowl as shown below. The water will only flow out of the bottle when the water level in the water bowl decreases.

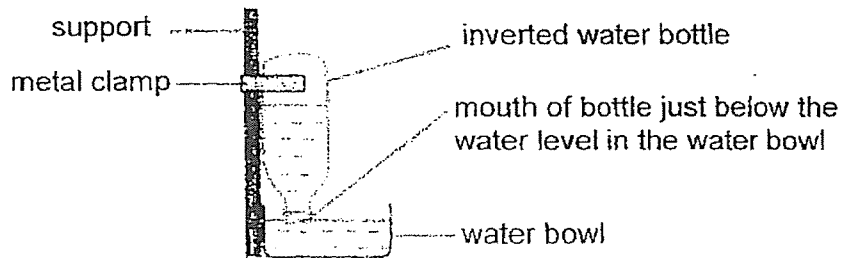

- (b) Explain why the water does not flow out of the bottle when the mouth of the bottle is below the water level in the water bowl and will only flow out of the bottle when the water level in the water bowl decreases. [2]

---



---



---

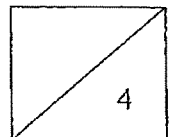

(Go on to the next page)

- 12 Mrs Lee filled a beaker with 500 cm<sup>3</sup> of water and lowered solid S carefully into it as shown below.

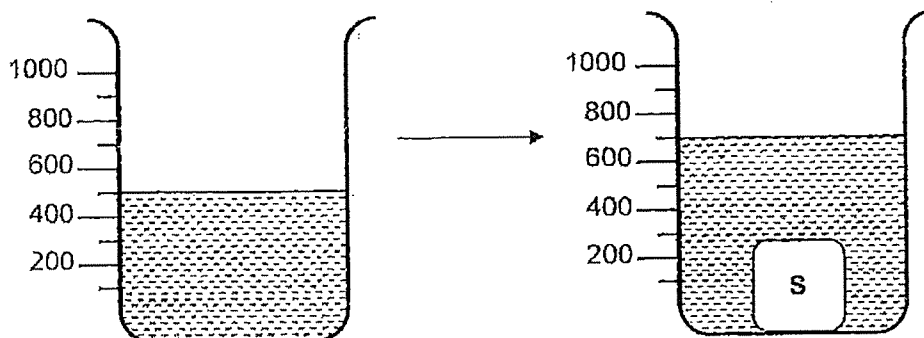

- (a) What is the volume of solid S? [1]

\_\_\_\_\_ cm<sup>3</sup>

Mrs Lee removed solid S from the beaker and broke it up completely into 4 equal smaller cubes as shown below.

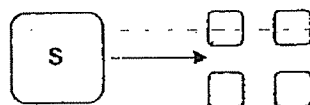

- (b) She then placed all the 4 smaller cubes back into the same beaker with 500 cm<sup>3</sup> of water. What will be the total volume of 4 smaller cubes and water? Which property of solid is shown? [2]

\_\_\_\_\_  
\_\_\_\_\_

Mrs Lee filled up container D with 800 ml of water as shown below. She then gently lowered one of the smaller cubes from solid S to the bottom of container D.

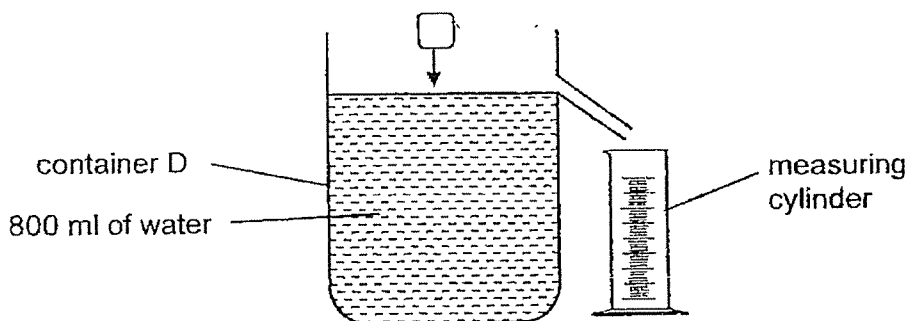

- (c) What will be the volume of water collected in the measuring cylinder? [1]

\_\_\_\_\_ ml

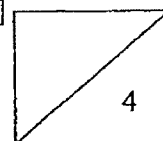

(Go on to the next page)

- 13 Karen covered the opening at C of the communicating vessel with a rubber stopper. She poured 300 ml of water into the opening at A as shown in diagram 1 below.

Karen then placed a rubber ball into the communicating vessel as shown in diagram 2.

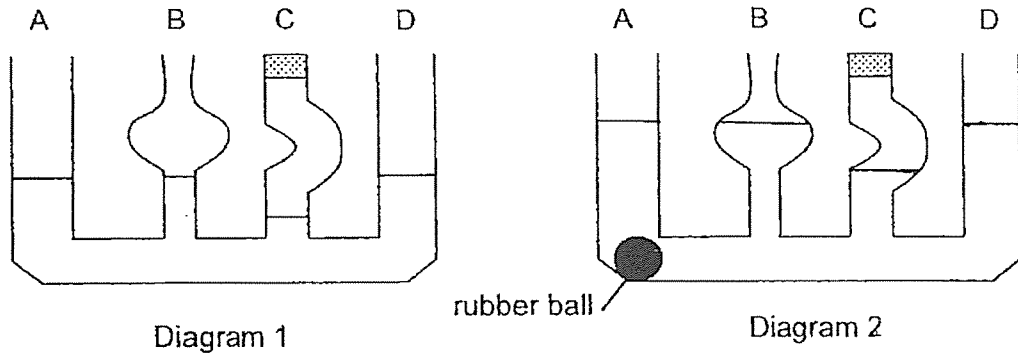

- (a) Draw the correct water levels for A, B, C and D in diagram 2 above after the rubber ball was placed into the communicating vessel. [1]
- (b) Next, Karen packed six towels in a bag and placed them on an electronic balance as shown below. She observed that the mass of the six towels with the bag was 120g.

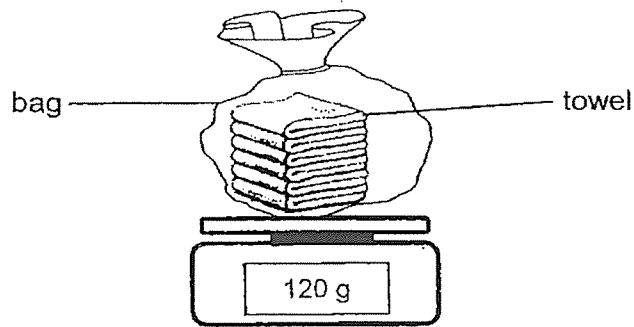

- (c) She concluded that the mass of each towel was 20g. Based on the measurements, give a reason why her conclusion was not correct. [1]

---



---



---

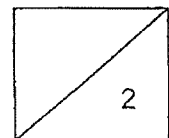

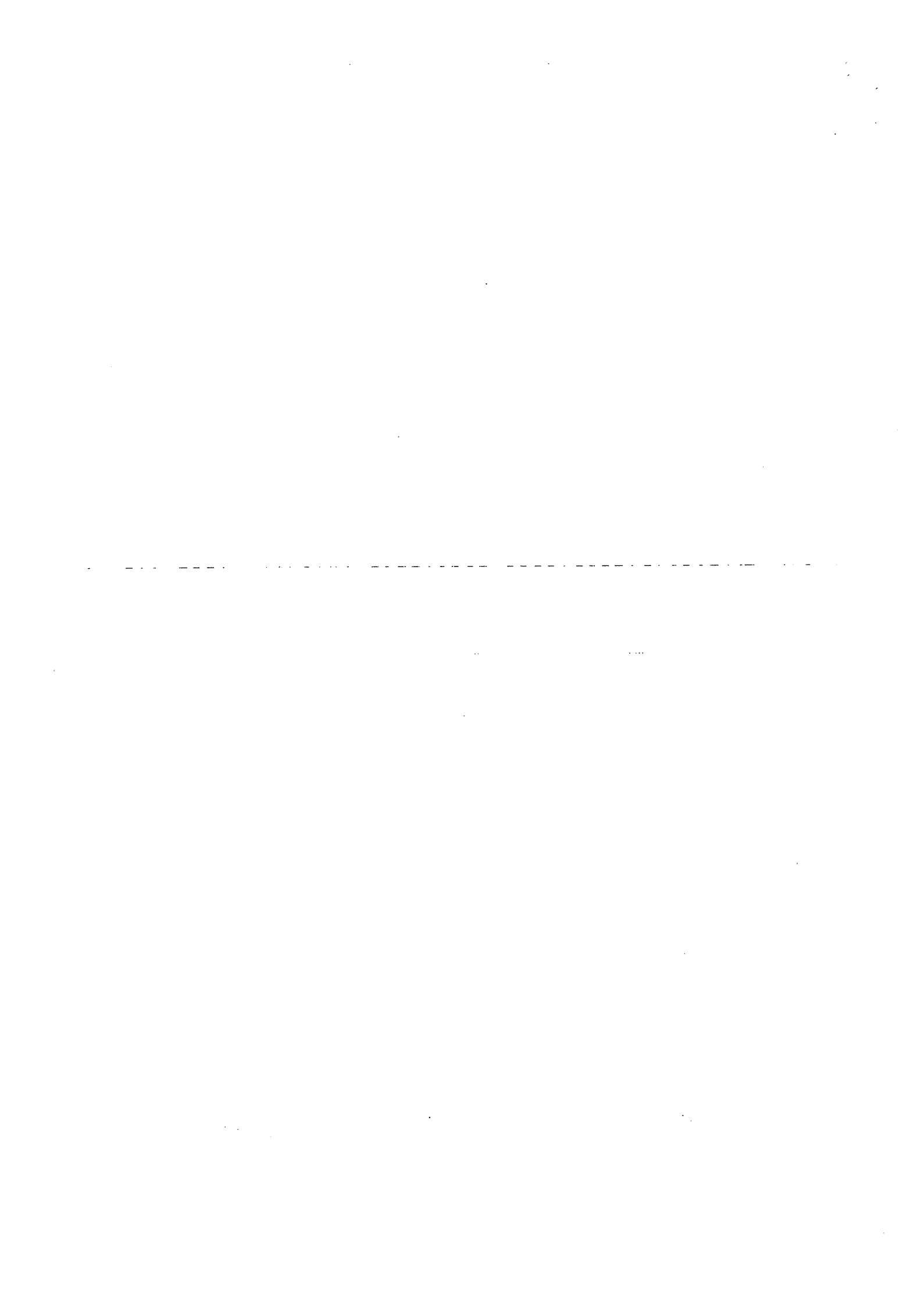

METHODIST GIRLS' SCHOOL  
Founded in 1887



PRIMARY 4  
SCIENCE  
WEIGHTED ASSESSMENT 3 2023

Total Time for Paper: 45 min

INSTRUCTIONS TO CANDIDATES

Do not turn over this page until you are told to do so.

Follow all instructions carefully.

Answer all questions.

Name: \_\_\_\_\_ ( )

Class: Primary 4 \_\_\_\_\_

Date: \_\_\_\_\_

Parent's signature: \_\_\_\_\_

Section A	18
Section B	12
Total	30

This paper consists of 10 printed pages including this page.

**Section A**

For each question from 1 to 9, four options are given. One of them is the correct answer. Make your choice (1, 2, 3 or 4) and write in the bracket provided. [18 marks]

- 1 The diagram below shows two steel blocks, J and K.

Both blocks are heated to  $85^{\circ}\text{C}$ . Which of the following statements is/are true?

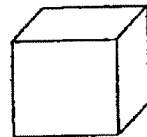

Block J



Block K

- A Block K is hotter than Block J.  
 B Block J has more heat energy than Block K.  
 C Both blocks will take different amount of time to reach room temperature.

- (1) B only  
 (2) C only  
 (3) A and C only  
 (4) B and C only

( )

- 2 A cup of hot milk is placed into a basin of cold water.

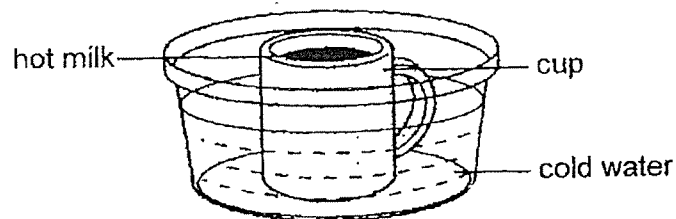

Which of the following correctly describes the heat transfer that took place?

	<b>cold water</b>	<b>hot milk</b>	<b>cup</b>
(1)	lost heat to cup	lost heat to cup	lost heat to hot milk
(2)	lost heat to cup	gained heat from cup	lost heat to hot milk
(3)	gained heat from cup	lost heat to cup	gained heat from hot milk
(4)	gained heat from cup	gained heat from cup	gained heat from hot milk

( )

(Go on to the next page)



- 3 The diagram below shows an empty conical flask with a T-shaped tube. X and Y are two drops of ink in the tube. The conical flask was then immersed into a container of hot water at 95°C.

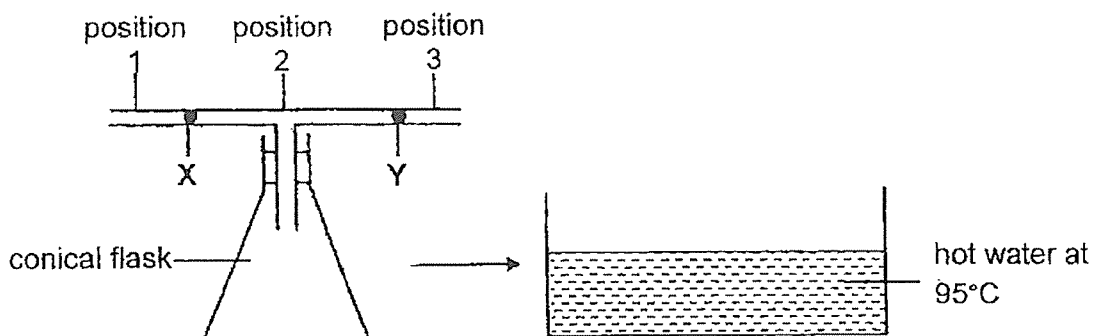

What will be positions of ink drops X and Y after the conical flask is placed into the hot water for 5 minutes?

	X	Y
(1)	Position 1	Position 2
(2)	Position 1	Position 3
(3)	Position 2	Position 2
(4)	Position 2	Position 3

- 4 Four similar hot iron cubes were heated to 80°C. The cubes were then put into four beakers at the same time as shown below.

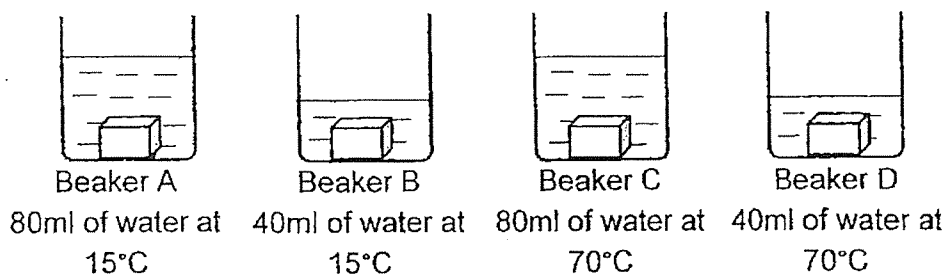

Which beaker of water will have the greatest increase in temperature?

- (1) Beaker A  
 (2) Beaker B  
 (3) Beaker C  
 (4) Beaker D

(Go on to the next page)

- 5 Elisa wanted to find out whether glass or plastic is a better conductor of heat. She filled the cups with water of the same volume and temperature, as shown below. She then measured the temperature of water every five minutes.

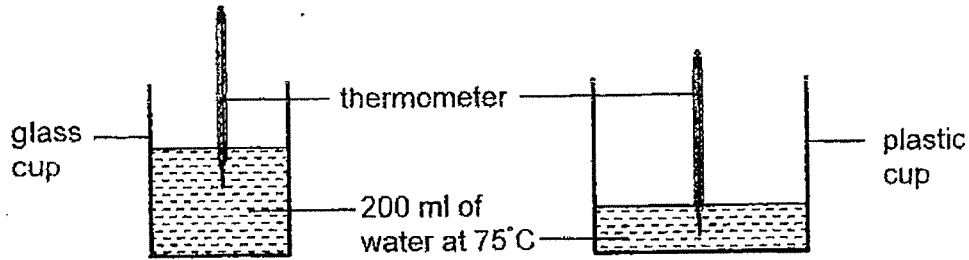

What should Elisa do to ensure that her experiment is a fair test?

- (1) Use cups of the same size.
  - (2) Cover the cups with a metal lid.
  - (3) Pour the water to the same level in each cup.
  - (4) Use water of a lower temperature in each cup. ( )
- 
- 6 Which of the following will not change when a matter is being heated?
- (1) mass
  - (2) state
  - (3) volume
  - (4) temperature ( )
- 7 Which of the following statements about light is correct?
- (1) Only shiny objects reflect light.
  - (2) Objects that reflect light are sources of light.
  - (3) An object can be seen when it is able to reflect light.
  - (4) Objects can be seen because our eyes give off light. ( )

(Go on to the next page)

- 8 Ben poured equal volume of water at  $10^{\circ}\text{C}$  into four similar sized containers made of materials, W, X, Y and Z. He then left the four containers in the kitchen.

After some time, the temperature of the water in each container is recorded in the bar graph shown below.

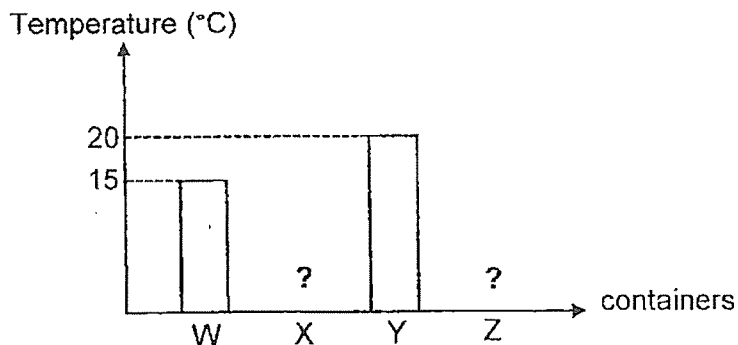

Based on the results, Ben concluded that material X is the best conductor of heat and material Z is the poorest conductor of heat.

Which bar graph correctly shows the temperature of water in the containers made of materials X and Z after some time?

(1) Temperature ( $^{\circ}\text{C}$ )

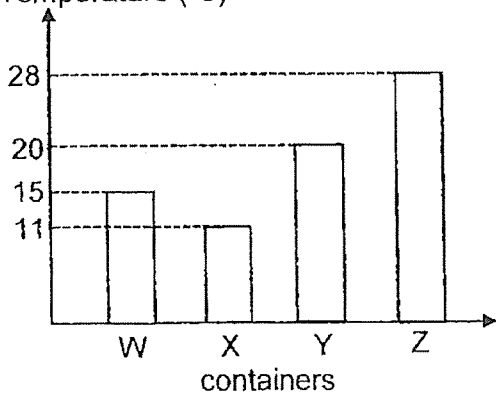

(2) Temperature ( $^{\circ}\text{C}$ )

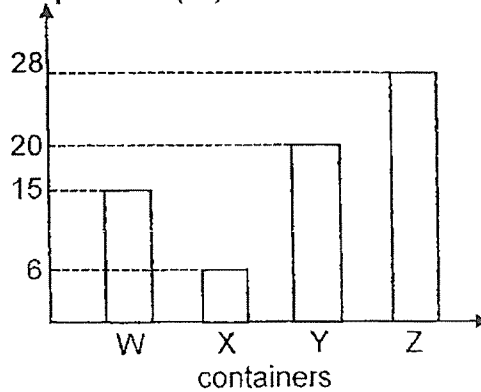

(3) Temperature ( $^{\circ}\text{C}$ )

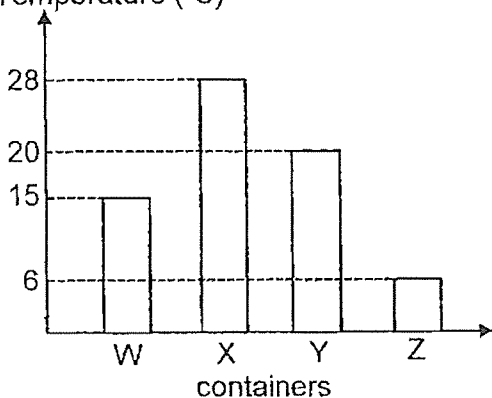

(4) Temperature ( $^{\circ}\text{C}$ )

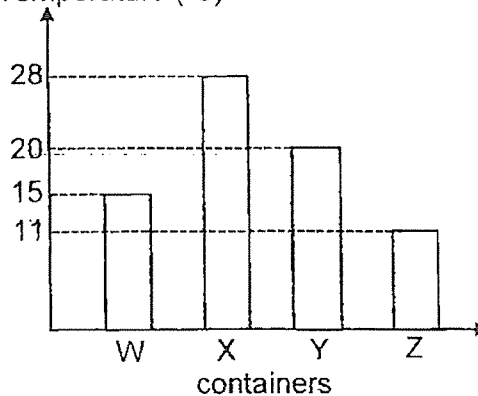

( )

(Go on to the next page)

- 9 Siti conducted an experiment to investigate the amount of light that passes through three sheets, A, B and C, of the same thickness and size but made of different materials.

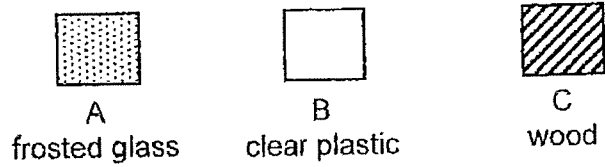

Siti recorded the amount of light that passed through sheet A as shown in the diagram below.

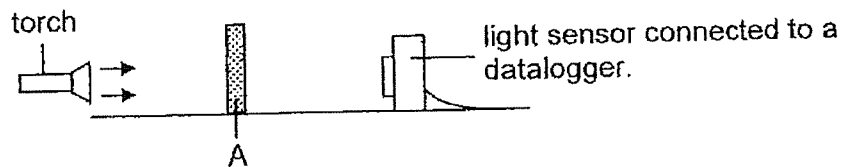

She repeated the experiment with sheets A and B attached together.

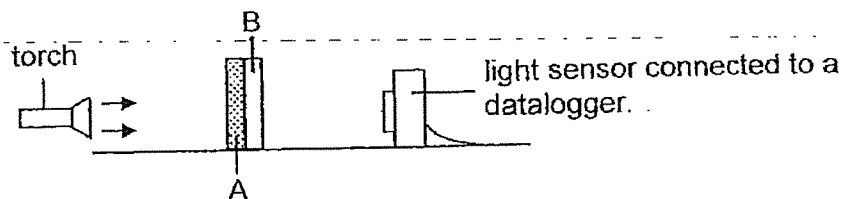

Finally, she repeated the same experiment with A, B and C attached together.

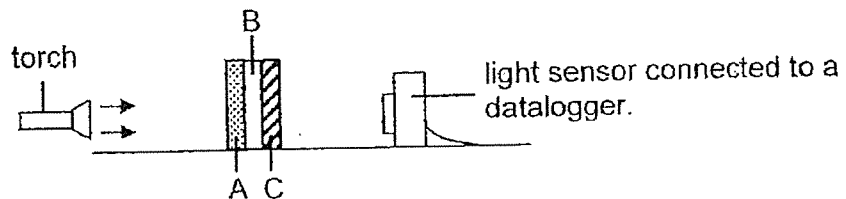

Which of the following correctly shows the results of the experiment?

	Amount of light recorded by datalogger (unit)		
	A only	A and B attached	A, B and C attached
(1)	100	300	400
(2)	100	100	0
(3)	300	300	100
(4)	300	100	0

(Go on to the next page)

**Section B**

For questions 10 to 12, write your answers in the space provided.

[12 marks]

- 10 Mrs Lim placed a scoop of ice cream into a metal cup in the kitchen as shown in diagram 1 below.

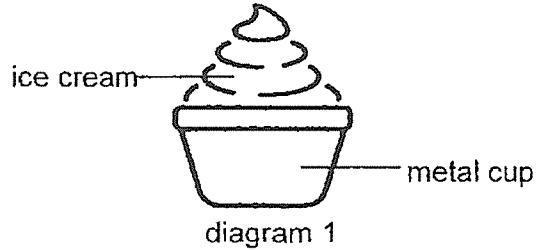

- (a) State the change in state of the ice cream after some time. [1]

---

- (b) Explain your answer in (a) [1]

---



---

Mrs Lim then placed another similar scoop of ice cream into a plastic cup in the same room as shown in diagram 2 below. The size and thickness of plastic cup is similar to the metal cup in diagram 1.

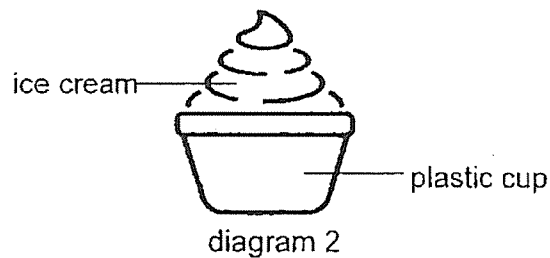

- (c) Will the ice cream with the plastic cup in diagram 2 melt faster, slower, or at the same time as the ice cream in diagram 1? Explain your answer. [2]

---



---

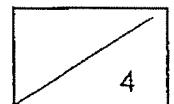

(Go on to the next page)

- 11 Lucy conducted an experiment using set-ups A and B as shown below. Both cups were filled with the same volume of hot water at  $90^{\circ}\text{C}$  and left in the kitchen.

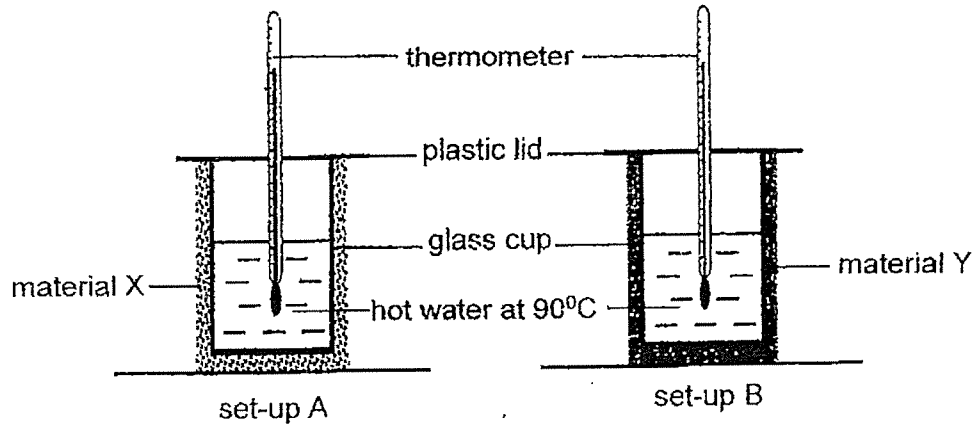

She measured the temperature of water at different times and plotted her results in the graph as shown below.

Time (min)	Temperature of water in ( $^{\circ}\text{C}$ )	
	Set-up A	Set-up B
5	90	90
10	82	71
15	71	60
20	67	51

- (a) Based on the table, which material, X or Y is a better conductor of heat? Explain your answer. [1]

---



---

- (b) How did the temperature of water in both set-ups change after two hours? [1]

---



---

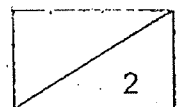

(Go on to the next page)

- (c) . The concrete tile on the pavement have gaps in between them as show below.

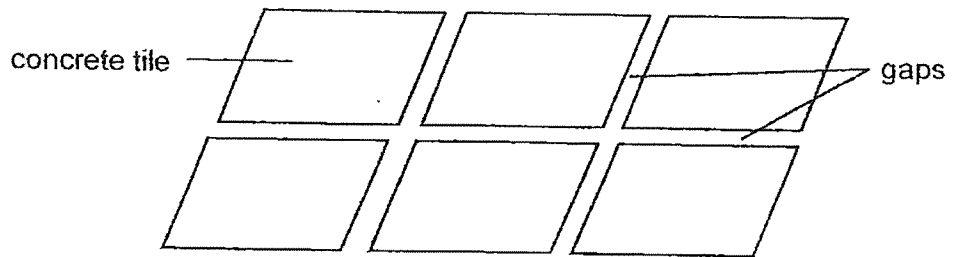

What would happen to the concrete tile on a very hot day if there were no gaps?  
Explain your answer. [2]

---

---

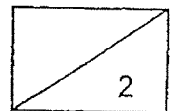

(Go on to the next page)

- 12 Ann designed a model that uses a light sensor to count sheets of paper as shown below.

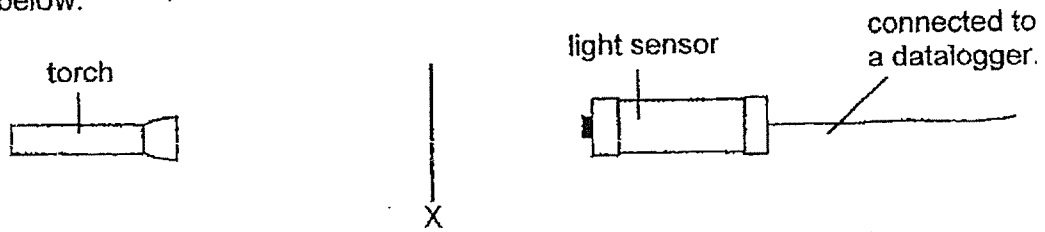

- (a) When no paper was placed at position X, the amount of light detected by the sensor was 200 units. When a sheet of paper was placed at X, the reading became 150 units. Explain why. [1]

---



---

Next, Ann repeated the experiment by increasing the number of sheets of the same type of paper. The table below shows her results.

Number of sheets of paper	Amount of light (units)
0	200
1	150
2	100
3	50
4	0
5	0

- (b) Explain why the model cannot be used to count more than 4 sheets of paper? [2]

---



---

- (c) Using only the above apparatus, state one change that Ann could make to the model if she wants to count more than 4 sheets of the same type of paper. [1]

---



---

End of paper

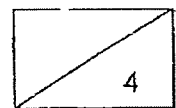



SCHOOL : METHODIST GIRLS' SCHOOL  
LEVEL : PRIMARY 4  
SUBJECT : SCIENCE  
TERM : 2023 WA 1

---

**WA1**

**SECTION A**

Q 1	Q2	Q3	Q4	Q5	Q6	Q7			
4	4	2	2	3	1	1			

**SECTION B**

Q8)	a) (i) Living things change and grow (ii) Living things reproduce b) The life cycle of a frog has 3 stages while that of a butterfly has 4 stages c) Both life cycles start with the egg stage d) Laying many eggs increase the chance of survival and development into adult stage
Q9)	a) Temperature of the surroundings b) As the temperature of the surroundings increases, the height of the plant increases c) 20 degrees is the least suitable temperature for the growth of the plants, as the height of the plant at 20 degrees was the shortest.
Q10)	a) Stage Z: Pupa b) C c) The mosquito at stage Y eats a lot and molts several times d) By emptying the water collected in the plate, the adult mosquito will have no place to lay their eggs, so it will be harder for the mosquito to breed.

SCHOOL : METHODIST GIRLS' SCHOOL  
 LEVEL : PRIMARY 4  
 SUBJECT : SCIENCE  
 TERM : 2023 WA 2

**SECTION A**

Q 1	Q2	Q3	Q4	Q5	Q6	Q7	Q8	Q9	
2	1	1	4	2	1	3	4	4	

**SECTION B**

Q10)	<p>a) Substance P: Gaseous Substance Q: Liquid</p> <p>b) Matter in the gaseous state can be compressed but matter in liquid state cannot be compressed</p>
Q11)	<p>a) Water in the container would overflow. Air does not have a definite volume, so balloon will expand and occupy a larger area hence displacing the water and causing it to overflow.</p> <p>b) Water has a definite volume and cannot be compressed, so the water in the bottle cannot overflow into the water bowl as the water in the bow is occupying space.</p>
Q12)	<p>a) <math>200\text{cm}^3</math></p> <p>b) The total volume of 4 smaller cubes and water will be <math>700\text{cm}^3</math>. The property of solids shown is solids have definite volume</p> <p>c) 50ml</p>
Q13)	<div style="text-align: center;"> <p>Diagram 2</p> </div> <p>a)</p> <p>b) 120g is the mass of the towels and the bag because the towels were in the bag when Karen measured them.</p>

**SCHOOL : METHODIST GIRLS' SCHOOL**  
**LEVEL : PRIMARY 4**  
**SUBJECT : SCIENCE**  
**TERM : 2023 WA 3**

---

Q 1	Q2	Q3	Q4	Q5	Q6	Q7	Q8	Q9	
4	3	2	2	1	1	3	4	2	

**SECTION B**

Q10)	<p>a) The ice cream changed from solid state to liquid state</p> <p>b) The ice cream gained heat from the surrounding air, causing it to melt and change state</p> <p>c) Ice cream in the plastic cup will melt slower than ice cream in diagram 1. Plastic is a poorer conductor of heat than metal, so ice cream in plastic cup will gain heat at a slower rate</p>
Q11)	<p>a) Y. The temperature of water in set-up B decreases faster as heat from the hot water will flow to the surrounding air more quickly</p> <p>b) The temperature of water in both set-ups gradually reached room temperature after 2 hours.</p> <p>c) The concrete tiles would crack on a very hot day if there were no gaps. The tiles would gain heat from the sun and expand, but there would be no space for the tiles to expand, causing them to crack</p>
Q12)	<p>a) The sheet of paper only allows some light to pass through, thus reading became 150 units</p> <p>b) When 4 sheets of paper were placed together, no light could pass through. Hence adding any additional sheets will not make a difference</p> <p>c) She can move the torch nearer to position X</p>

