

Catholic High School (Primary)  
Primary 4 Science 2023  
Weighted Assessment 1

Name: \_\_\_\_\_ ( )

Class: Pri 4 \_\_\_\_\_

MARKS	15
-------	----

Date: 20 February 2023

1. Completion of the Grow a Green Bean Plant Activity (Teacher to fill in) [3]



2. (a) State the part of the green bean seed that grows first. [1]

\_\_\_\_\_

- (b) Give a reason why your answer in part (a) grows first. [1]

\_\_\_\_\_  
\_\_\_\_\_

3. (a) Complete the life cycle of a green bean plant in the space below. One of the stages has been drawn for you. [2]

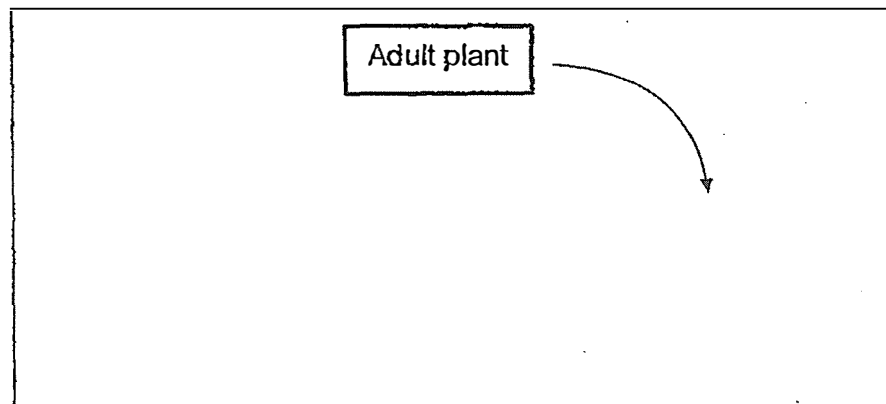

- (b) When does the green bean plant start to make its own food? [1]

\_\_\_\_\_  
\_\_\_\_\_

SCORE	8
-------	---



4. The table below shows some characteristics of the life cycle of a beetle. Name the stage(s) in the space provided. [2]

	Characteristics	Stage(s)
(i)	moults several times as it grows	
(ii)	stops feeding and continues to develop	

5. Animals such as the grasshopper lays many eggs each time.

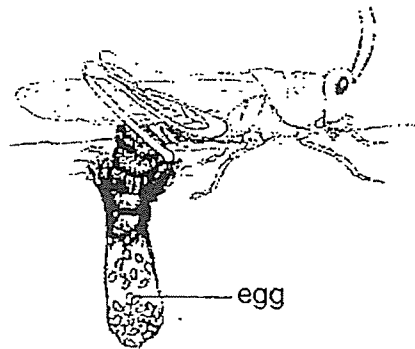

How does laying many eggs help the grasshopper in their survival? [1]

---

---

6. Paste the four given pictures in the boxes provided to complete the flow chart below. [4]

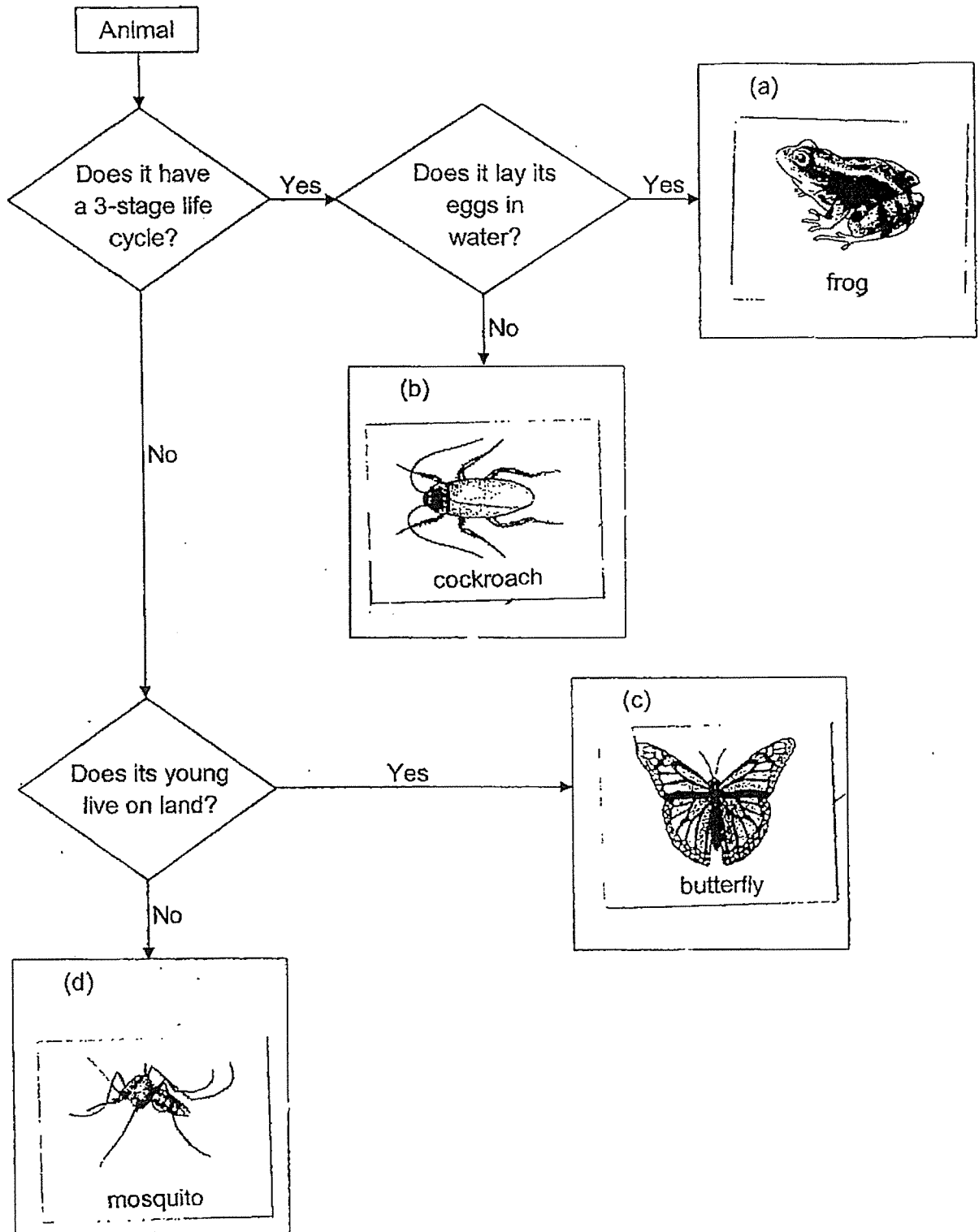

**Catholic High School (Primary)  
Primary 4 Science 2023  
Weighted Assessment 2**

Name: \_\_\_\_\_ ( )

Class: Pri. 4 - \_\_\_\_\_

Date: 8 May 2023

Parent's Signature: \_\_\_\_\_

MARKS	20
-------	----

**Section A (6 × 2 marks)**

For each question from 1 to 6, four options are given. One of them is the correct answer. Make your choice (1, 2, 3 or 4). Write its correct number in the brackets provided.

(12 marks)

1 The diagram shows the stages of a bean plant.



stage P

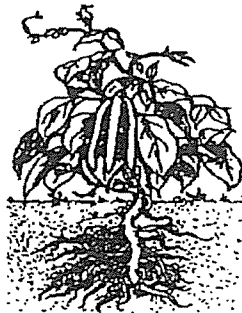

stage Q

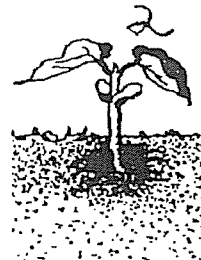

stage R

Which of the following correctly shows the life cycle of the bean plant?

(1)

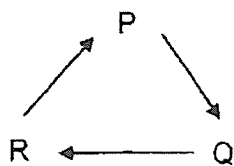

(2)

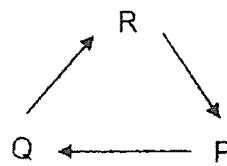

(3)

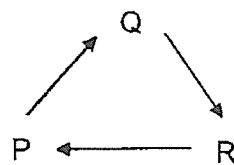

(4)

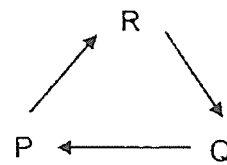

( )

- 2 Chandra kept four animals, A, B, C and D, in four different containers. These animals are at different stages of growth.

The table shows the amount of food given in the beginning and the amount of food left after a week.

Animal	Amount of food in the beginning (g)	Amount of food left after a week (g)
A	20	18
B	20	20
C	20	9
D	20	5

Which animal is likely to be in the pupal stage?

- (1) animal A
- (2) animal B
- (3) animal C
- (4) animal D

( )

- 3 Which statements about matter are correct?

- A All matter can be seen and felt.
- B Things around us are made of matter.
- C All matter has definite shape and definite volume.
- D Matter is anything that has mass and occupies space.

- (1) A and C only
- (2) B and C only
- (3) B and D only
- (4) A, C and D only

( )

- 4 Alex, Brianne and Chen Xin filled a bucket with sand. They continued to pour more sand into the bucket and observed that the sand flowed out of the bucket. They made the following statements about sand.



Sand occupies space.

Alex



Sand is a liquid and takes the shape of the bucket.

Brianne



Sand has a definite volume.

Chen Xin

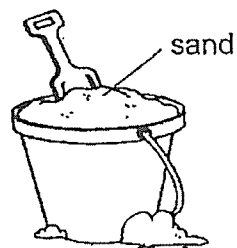

Who made the correct statement(s)?

- (1) Alex only
- (2) Brianne only
- (3) Alex and Chen Xin only
- (4) Brianne and Chen Xin only

( )

5 Which instrument can be used to measure volume?

(1)

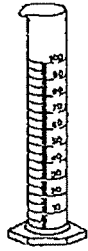

(2)

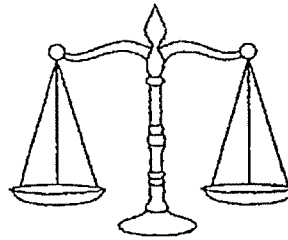

(3)

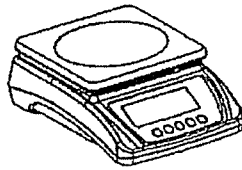

(4)

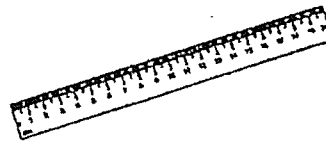

( )

6 We can see the chair because it \_\_\_\_\_.

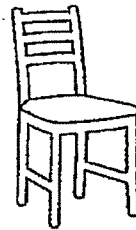

- (1) gives off light
- (2) reflects light into our eyes
- (3) blocks light going into our eyes
- (4) allows light to pass through our eyes

( )



**Section B (8 marks)**

For questions 7 to 9, write your answers in this booklet.

The number of marks available is shown in brackets [ ] at the end of each question or part question. (8 marks)

---

7 The pictures show the different stages of the life cycle of a butterfly.

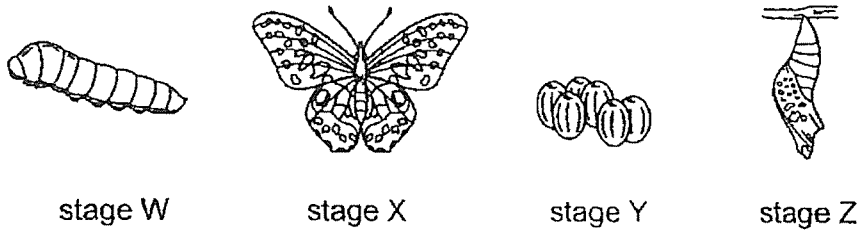

(a) Name the stages. [1]

stage W : \_\_\_\_\_

stage Y : \_\_\_\_\_

(b) At which stage, W, X, Y or Z, is the butterfly harmful to plants? Give a reason. [1]

\_\_\_\_\_  
\_\_\_\_\_

(c) How does laying many eggs help the butterfly in their survival? [1]

\_\_\_\_\_  
\_\_\_\_\_

(Go on to the next page)

SCORE	3
-------	---

- 8 Celine had two containers with a capacity of  $500\text{ cm}^3$ . She filled container X with  $200\text{ cm}^3$  of water and container Y with pebbles to the  $200\text{-cm}^3$  marking.

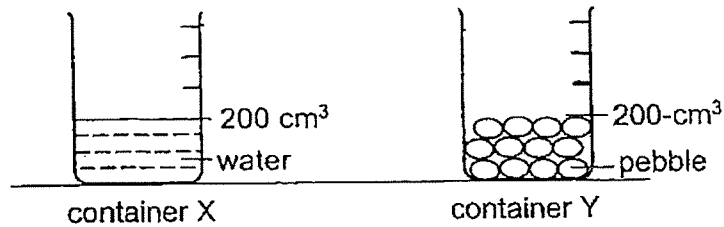

- (a) She poured all the water from container X into container Y.

What would be the total volume of the pebbles and water in container Y?

Put a tick ( $\checkmark$ ) in the box to show the correct volume.

[1]

Total volume of pebbles and water	Put a tick ( $\checkmark$ )
more than $400\text{ cm}^3$	
$400\text{ cm}^3$	
less than $400\text{ cm}^3$ but more than $200\text{ cm}^3$	

- (b) Explain your answer in (a).

[1]

---



---

Celine then poured  $450\text{ cm}^3$  of water into the container and attached an air pump to it. She pumped in  $100\text{ cm}^3$  of air into the container which had a capacity of  $500\text{ cm}^3$ .

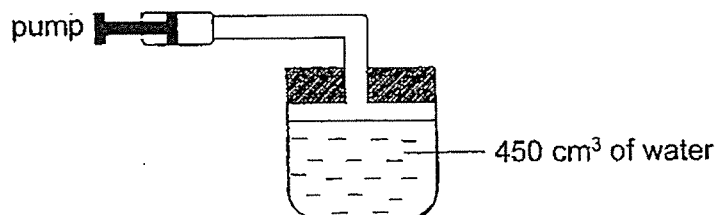

- (c) What is the total volume of air in the container? Explain your answer. [1]

---



---

(Go on to the next page)

SCORE	3
-------	---

- 9 Farhan placed a toy bear into a black box with a hole. He switched on the lamp and placed it beside the black box as shown.

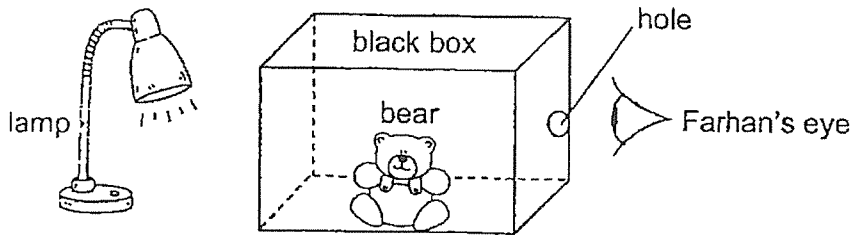

- (a) Would Farhan be able to see the bear when he peeped through the hole? Explain your answer. [1]

---



---

Farhan took out the bear from the black box and placed it on a table.

- (b) Which diagram shows the path of light that makes it possible for Farhan to see the bear? Put a tick (✓) in the box to show the correct path of light. [1]

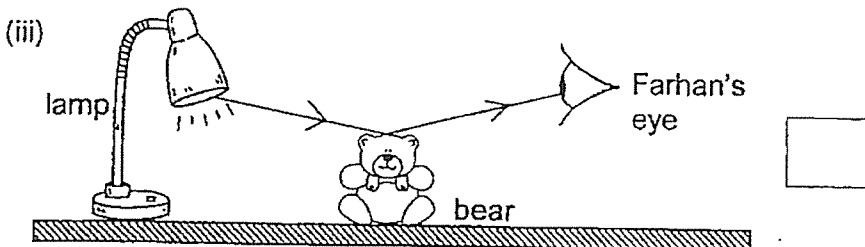
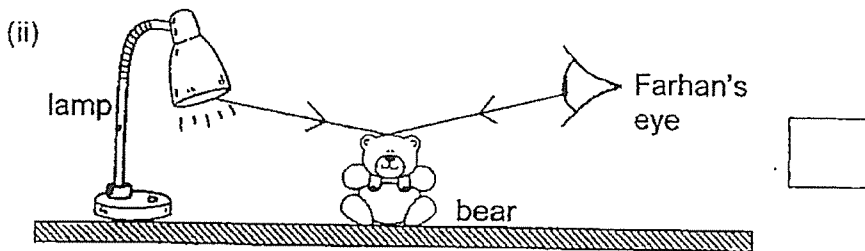
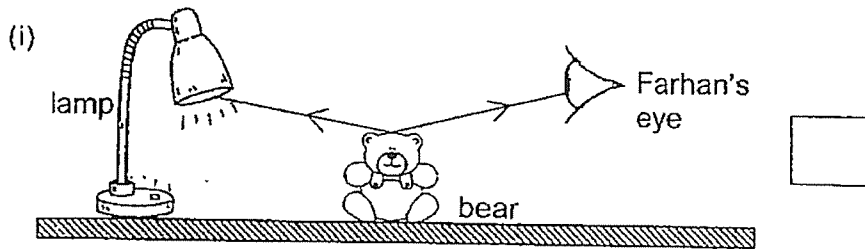

End of Paper

SCORE	2
-------	---



Catholic High School (Primary)  
Primary 4 Science 2023  
Weighted Assessment 3

Name: \_\_\_\_\_ ( )

Class: Pri. 4 - \_\_\_\_\_

Date: 14 August 2023

Parent's Signature: \_\_\_\_\_

MARKS	25
-------	----

**Section A (8 × 2 marks)**

For each question from 1 to 8, four options are given. One of them is the correct answer. Make your choice (1, 2, 3 or 4). Write the correct number in the brackets provided.

(16 marks)

- 1 The diagram shows a periscope. A periscope is an instrument that uses mirrors to allow people to look at things from a different position.

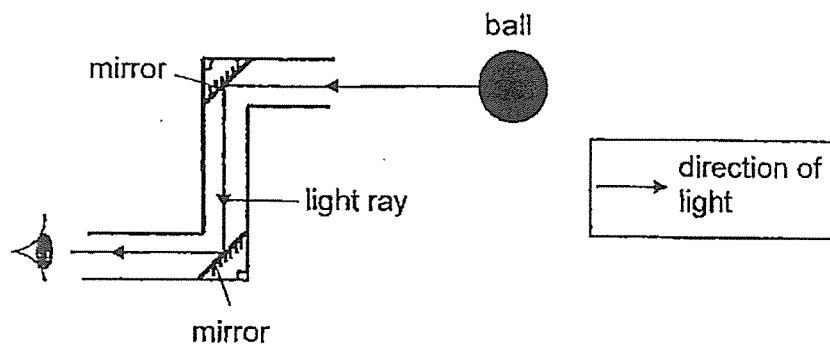

Which statement correctly describes why we can see the ball through a periscope?

- (1) The mirror can reflect light.
- (2) The mirror is a light source.
- (3) The ball can form a shadow.
- (4) Light does not travel in a straight line.

( )

2 Study the table.

Light sources	Non-light sources
sun moon fire	lit candle pencil cardboard

Which items are **not** placed correctly?

- (1) pencil and fire
- (2) cardboard and sun
- (3) moon and lit candle
- (4) moon and cardboard

( )

3 A shadow play is performed by placing a puppet between a screen and a torch.

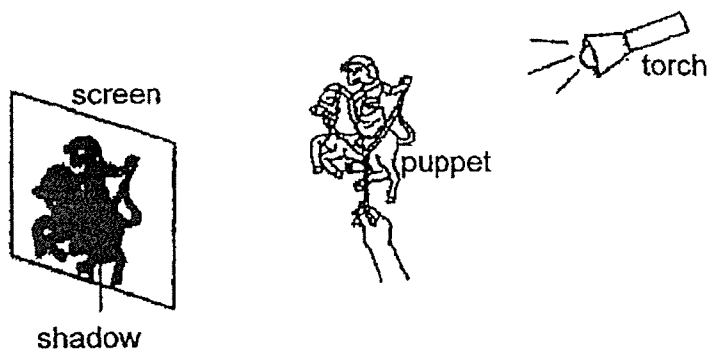

The shadow cast on the screen can be made bigger by moving the \_\_\_\_\_.

- (1) torch closer to the puppet
- (2) puppet further away from the torch
- (3) screen further away from the torch
- (4) screen further away from the puppet

( )

4 Joshua has three sheets of different materials cut into shapes.

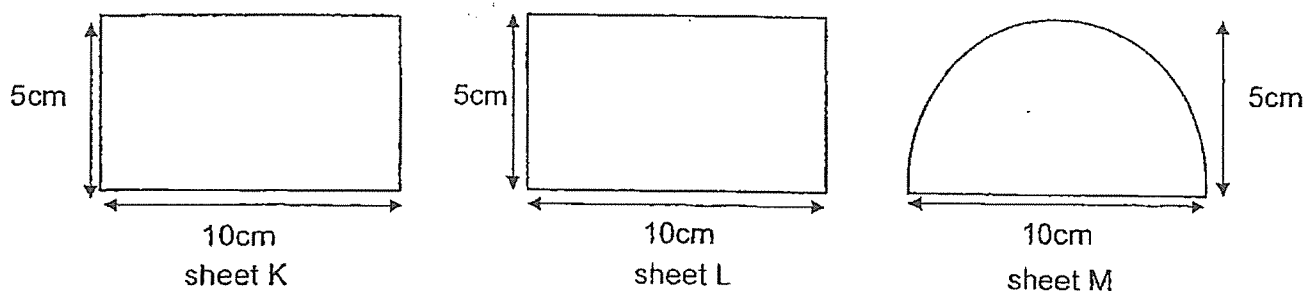

He conducted an experiment in a dark room using the set-up as shown.

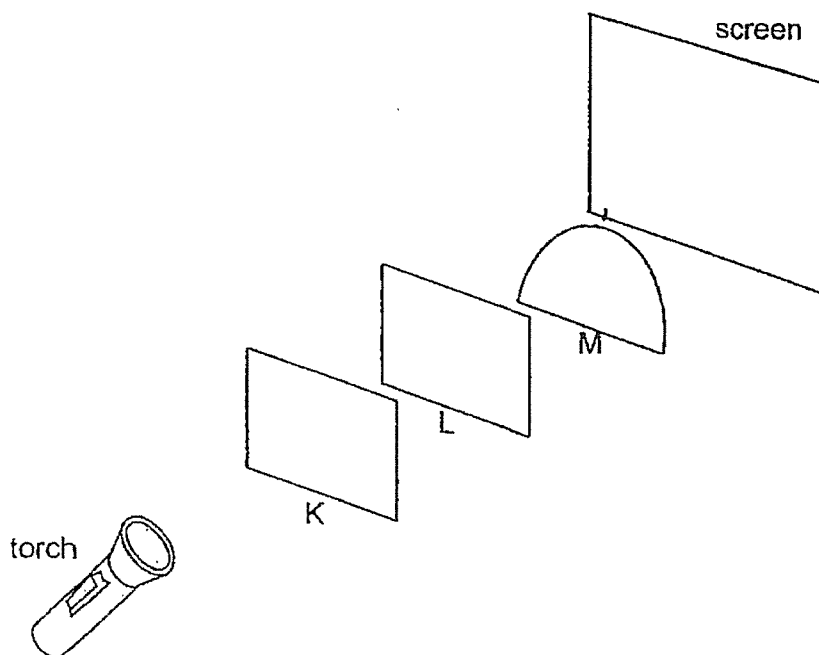

Joshua observed a shadow of a semicircle on the screen.

Which of the following is most likely correct?

	allows most light to pass through	allows some light to pass through	does not allow light to pass through
(1)	K		L, M
(2)	-	K, M	L
(3)	K, L	-	M
(4)	L	M	K

5 The diagram shows object X.

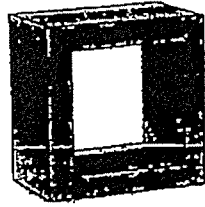

Which of the following would most likely be the shadow of object X?



A

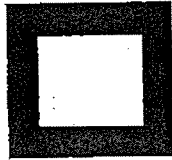

B

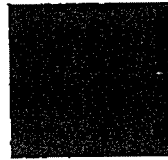

C



D

- (1) B only
- (2) A and B only
- (3) A, C and D only
- (4) B, C and D only

( )

6 Damien places a metal spoon in a bowl of hot soup.

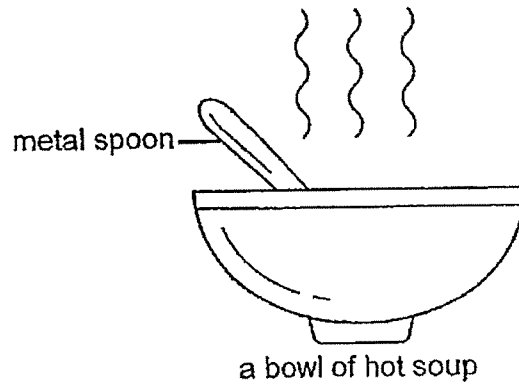

The metal spoon becomes hotter after a while. Which of the following explains this?

- (1) The bowl loses heat to the hot soup.
- (2) The hot soup gains heat from the bowl.
- (3) The metal spoon loses heat to the hot soup.
- (4) The metal spoon gains heat from the hot soup.

( )



7 Which statement is correct?

- (1) Temperature is a form of energy.
- (2) Heat always travels from a hotter place to a colder place.
- (3) The temperature of an object can be accurately measured by touching it.
- (4) Two beakers each containing 200ml and 500ml of water at  $90^{\circ}\text{C}$  have the same amount of heat. ( )

8 Ahmad placed two test tubes X and Y with equal amounts of water at different temperatures in basins of water in the Science Room.

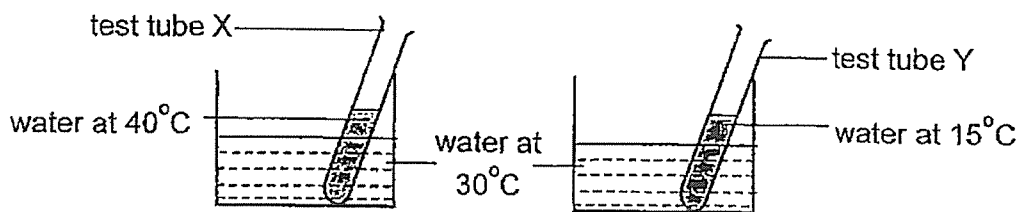

What are the possible temperatures of the water in test tubes X and Y after five minutes?

Temperature of water in test tubes ( $^{\circ}\text{C}$ )	
X	Y
(1) 20	20
(2) 50	30
(3) 40	15
(4) 30	25

( )

**Section B (9 marks)**

For questions 9 to 11, write your answers in this booklet.

The number of marks available is shown in brackets [ ] at the end of each question or part question. (9 marks)

- 9 Lynn hangs a wooden pyramid with a triangular base directly below a lamp which is fixed to the ceiling as shown.

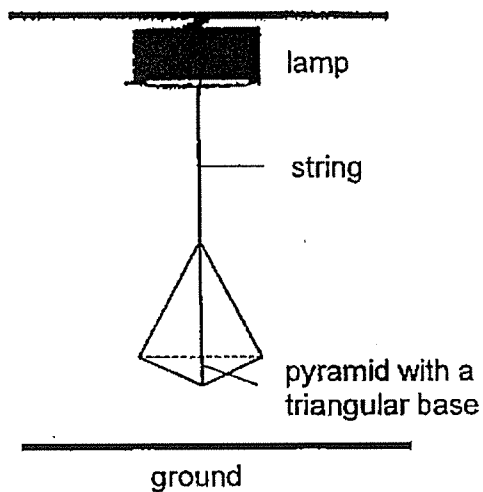

- (a) State how the shadow of the pyramid is formed on the ground. [1]

---

---

- (b) Draw how the shadow of the pyramid would look like in the box. [1]

(Go on to the next page)

SCORE	2
-------	---

Continue from Question 9

- (c) What can Lynn do to get a bigger shadow on the ground?  
Put a tick (✓) in the correct column.

[1]

Action	Tick (✓)
use a thicker string	
use a longer string	
use a shorter string	

Without making any other changes, Lynn turns the pyramid upside down.

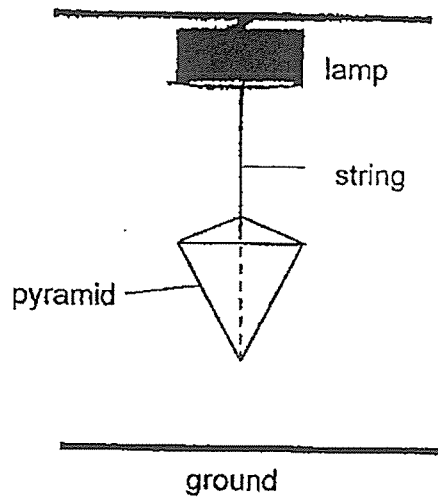

- (d) The shadow of the pyramid is observed to be bigger than before.  
Explain why.

[1]

---

---

(Go on to the next page)

SCORE	2
-------	---

10 Matt saw a ball in his room.

(a) Put a tick (✓) in the box to show the correct path of light that enables Matt to see the ball. [1]

(i)

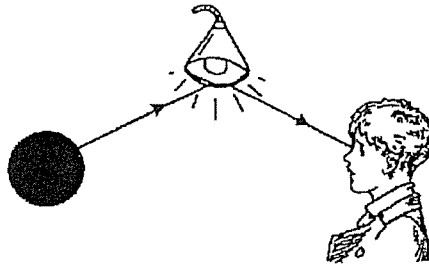

(ii)

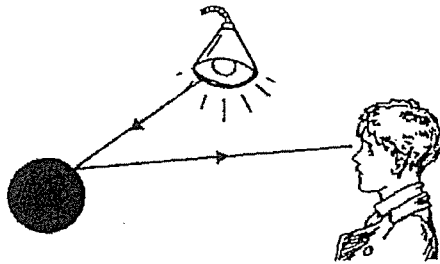

(iii)

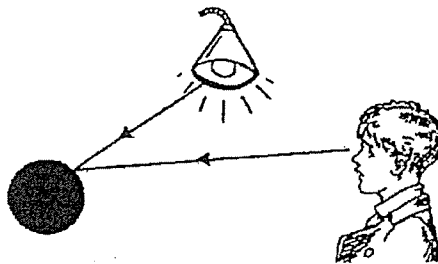

(b) Matt switched off the light and his room became completely dark. Explain why he could no longer see the ball. [1]

---

---

(Go on to the next page)

SCORE	2
-------	---

- 11 (a) State what temperature is. [1]

---

---

Belinda heated a beaker of water above a flame as shown.

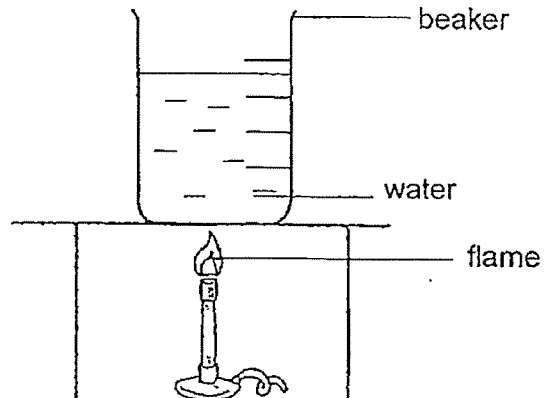

The flame was removed after 20 minutes.

- (b) Circle the correct change in the temperature of water in the beaker. [1]

The temperature of water in the beaker (increased / decreased / remained the same) after 20 minutes.

- (c) Explain your answer in (b). [1]

---

---

End of Paper

SCORE	3
-------	---



SCHOOL : CATHOLIC HIGH PRIMARY SCHOOL  
LEVEL : PRIMARY 4  
SUBJECT : SCIENCE  
TERM : 2023 WA 1

---

Q1)	Nil
Q2)	a) Roots b) Roots are needed for plant to take in water
Q3)	<p>a)  b) When the first true leaf appears</p>
Q4)	i) Larva ii) Pupa
Q5)	Ensure the likelihood of some eggs reaching adulthood as some eggs might be eaten
Q6)	a) Frog b) Cockroach c) Butterfly d) Mosquito

SCHOOL : CATHOLIC HIGH PRIMARY SCHOOL  
LEVEL : PRIMARY 4  
SUBJECT : SCIENCE  
TERM : 2023 WA2

---

SECTION A

Q 1	Q2	Q3	Q4	Q5	Q6
4	2	3	3	1	2

SECTION B

Q7)	a) Stage W: Larva Stage Y: Egg b) W. The larva eats the leaves of a plant c) Increase the chances of the butterfly reaching maturity/adulthood as some eggs may be eaten
Q8)	a) Any value within $200\text{cm}^3$ - $400\text{cm}^3$ b) In container Y, there are air spaces between pebbles which water can fill up. c) $50\text{cm}^3$ . Water cannot be compressed, while air can be compressed to fit the volume of the container.
Q9)	a) Light from the lamp is not reflected off the bear due to the black box obstructing the pathway of light. Hence bear cannot be seen. b) Tick (iii)



SCHOOL : CATHOLIC HIGH PRIMARY SCHOOL  
LEVEL : PRIMARY 4  
SUBJECT : SCIENCE  
TERM : 2023 WA3

---

**SECTION A**

Q 1	Q2	Q3	Q4	Q5	Q6	Q7	Q8
1	3	1	3	2	4	2	4

**SECTION B**

Q9)	<p>a) Shadow is formed when light is completely or partially blocked by pyramid</p>  <p>b)</p> <p>c) Use a shorter string</p> <p>d) The base of the pyramid is closer to the source of light</p>
Q10)	<p>a) tick (ii)</p> <p>b) The ball did not reflect any light into his eye, hence he cannot see it.</p>
Q11)	<p>a) Temperature is a measure of how hot or cold something is.</p> <p>b) Circle (Decrease)</p> <p>c) Hot water lost heat to the surroundings.</p>

