

PAYA LEBAR METHODIST GIRLS' SCHOOL (PRIMARY)

END OF YEAR EXAMINATION 2023

PRIMARY FOUR

SCIENCE

BOOKLET A

NAME : _____ ()

CLASS : P4 _____

DATE : 25 OCTOBER 2023

TOTAL TIME FOR BOOKLETS A & B: 1 hour and 45 minutes

INSTRUCTIONS TO PUPILS

DO NOT OPEN THIS BOOKLET UNTIL YOU ARE TOLD TO DO SO.

ANSWER ALL QUESTIONS.

Section A (28 x 2 = 56 marks)

For each question from 1 to 28, four options are given. One of them is the correct answer. Make your choice (1, 2, 3 or 4). Shade the correct oval (1, 2, 3 or 4) on the Optical Answer Sheet.

1. The diagram shows a bicycle.

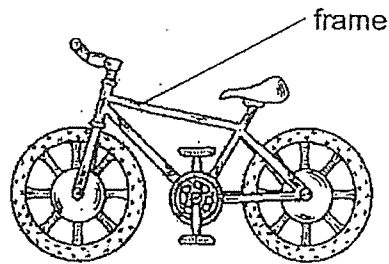

Metal is used to make the frame of the bicycle because metal _____.

- (1) reflects light
- (2) does not break easily
- (3) bends without breaking
- (4) does not allow light to pass through

2. Which one of the following parts takes in water for the plant?

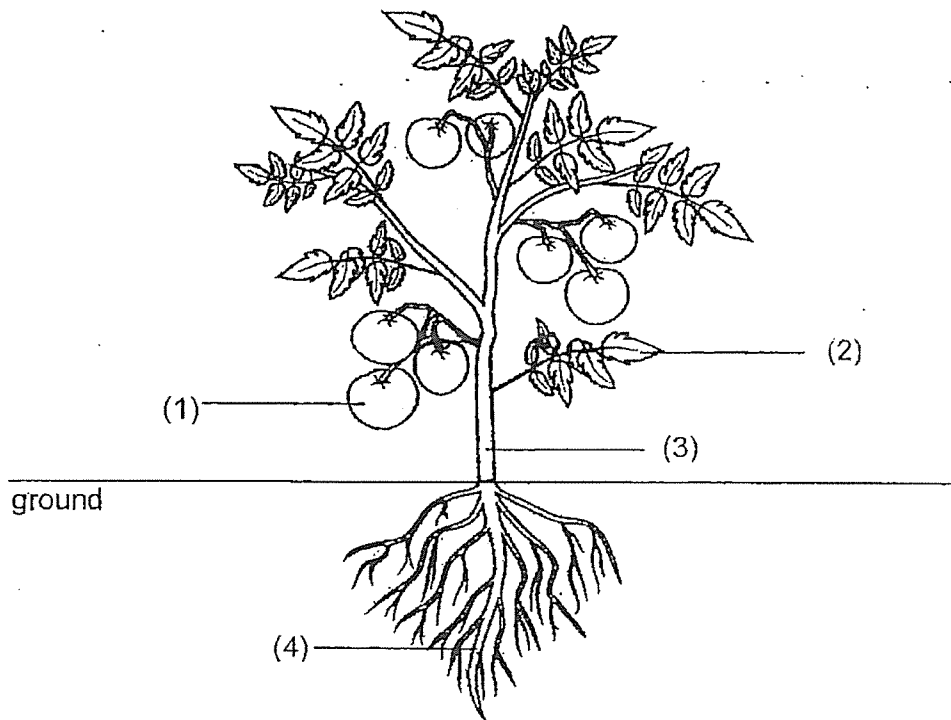

3. Study the diagram below.

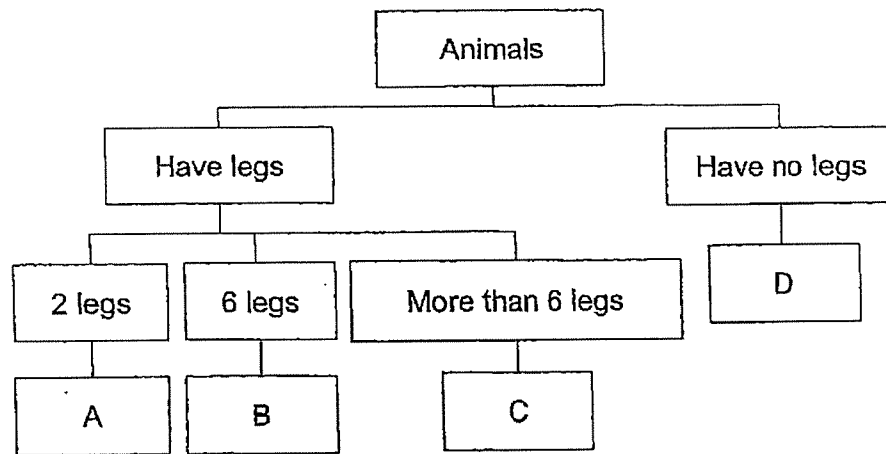

Where would you put this animal in the diagram above?

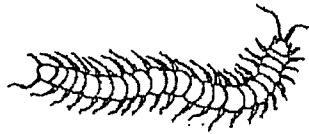

- (1) A
- (2) B
- (3) C
- (4) D

4. Which organ system is shown in the diagram?

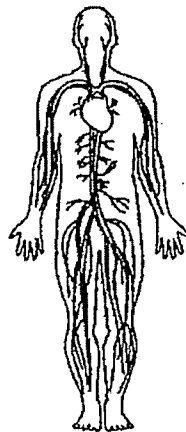

- (1) digestive system
- (2) muscular system
- (3) circulatory system
- (4) respiratory system

5. Which animal has a 3-stage life cycle?

(1) beetle

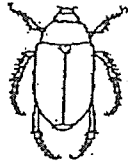

(2) mosquito



(3) chicken

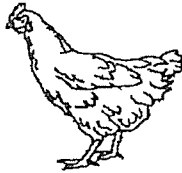

(4) butterfly

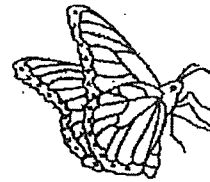

6. Which one of the following can be attracted by a magnet?

(1) steel ball

(2) glass ball

(3) plastic ball

(4) wooden ball

7. Which one of the following properties is true for both air and a ball?

(1) They can be seen.

(2) They take up space.

(3) They have fixed shapes.

(4) They have fixed volumes.

8. Which one of the following is a source of light?

(1)



the moon

(2)



a leaf

(3)

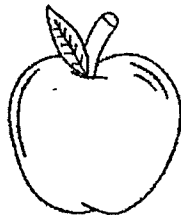

an apple

(4)



a candle flame

9. Which one of the following is **NOT** a source of heat?

- (1) The Sun
- (2) A lighted bulb
- (3) A candle flame
- (4) A woollen blanket

10. Which one of the following is a good conductor of heat?

- (1) metal spoon
- (2) ceramic cup
- (3) wooden block
- (4) plastic container

11. Jack wants to measure the temperature of hot water in a beaker.

Which one of the following diagrams shows the correct position of the thermometer when taking the temperature reading?

(1)

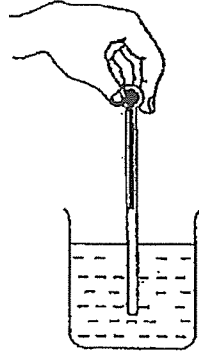

(2)

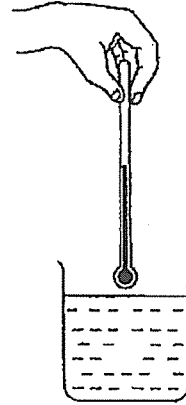

(3)

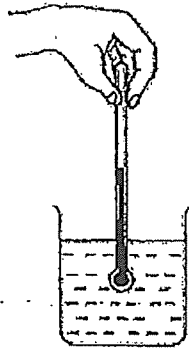

(4)

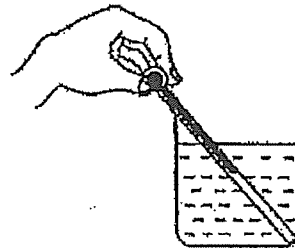

12. Face shields are used to protect health care workers as they prevent virus from being spread by a sick person.

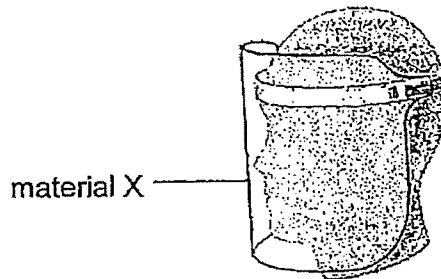

What properties must material X have to make it suitable for use as a shield?

- A waterproof
 - B float on water
 - C allow all light to pass through
- (1) A and B only
- (2) A and C only
- (3) B and C only
- (4) A, B and C
13. Andy found an animal in a river deep in a forest.
Which of the following characteristic should he use to identify it as a fish, reptile or amphibian?
- (1) presence of gills
 - (2) type of body covering
 - (3) number of body parts
 - (4) method of reproduction

14. At the start of the experiment, Janet puts three plants in the set-up as shown.

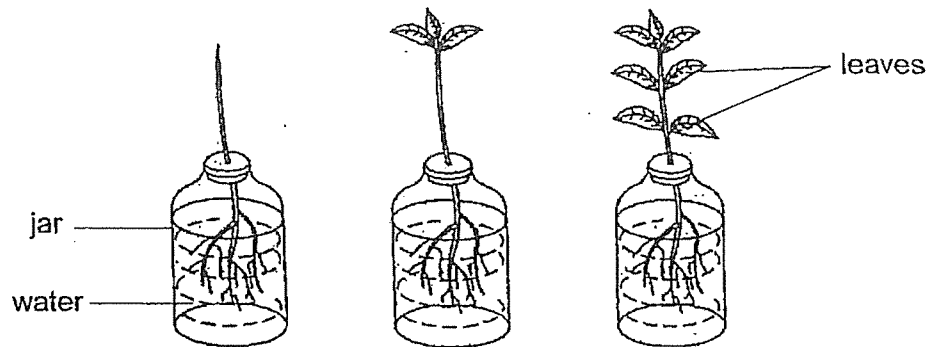

After one day, Janet measured the amount of water left in each jar.
What was Janet trying to find out?

She wanted to find out how water taken in by the plants is affected by the _____.

- (1) number of leaves
- (2) colour of leaves
- (3) shape of leaves
- (4) size of leaves

15. Which one of the following is correct?

	Organ involved in digestion of food	Organ involved in absorption of food
(1)	mouth	large intestine
(2)	stomach	large intestine
(3)	small intestine	small intestine
(4)	large intestine	small intestine

16. The graph below shows the length of time for the different stages in the life cycles of two types of butterflies, K and L.

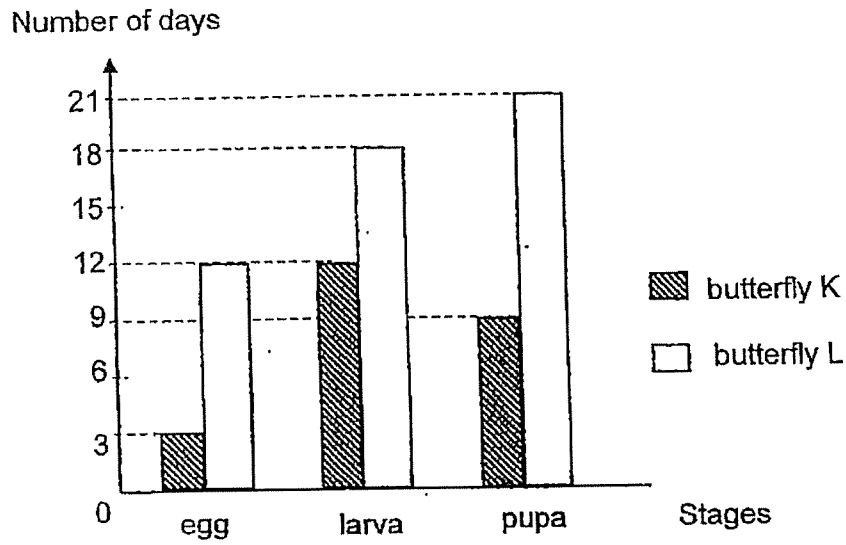

At which stage would butterflies K and L be on the 15th day after the eggs were laid?

	butterfly K	butterfly L
(1)	pupa	pupa
(2)	pupa	larva
(3)	adult	pupa
(4)	adult	larva

17. Shane wanted to pick up his metal toy ball from a sand pit using a bar magnet as shown below.

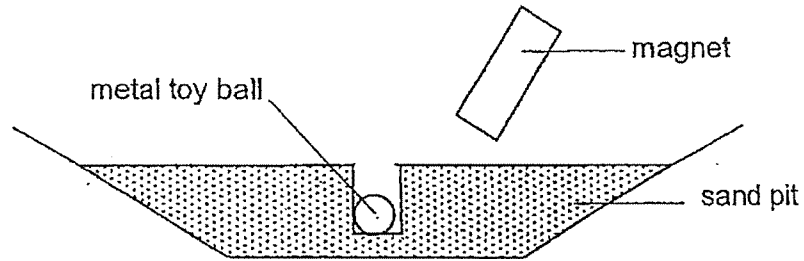

However, he found out that he could not remove his toy ball.

Which of the following are possible reasons for his observation?

- A The magnet is too far away from the ball
- B The ball is not made of magnetic material.
- C The ball is placed in the North-South direction.
- D The N-pole of the magnet is used to attract the ball.

- (1) A and B only
- (2) A and C only
- (3) B and D only
- (4) C and D only

18. Two identical syringes, Q and R, contain substance X and Y. One end of each syringe is sealed.

The plunger in syringe Q could be pushed in slightly while the plunger in syringe R could **not** be pushed in.

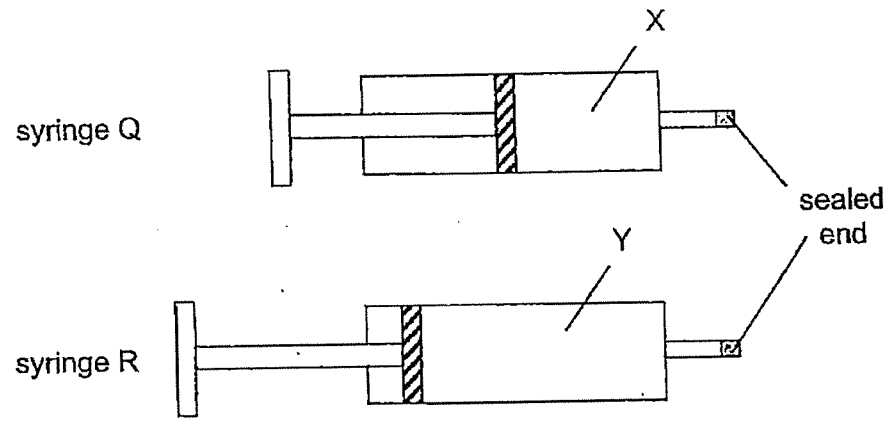

Which of the following substances are most likely to be X and Y?

	X	Y
(1)	water	air
(2)	air	oil
(3)	oil	water
(4)	oil	air

19. Edwin observed the interaction between a magnet and a compass.

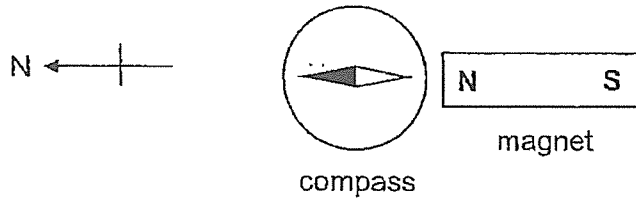

He placed four compasses, A, B, C and D, near two magnets as shown below.

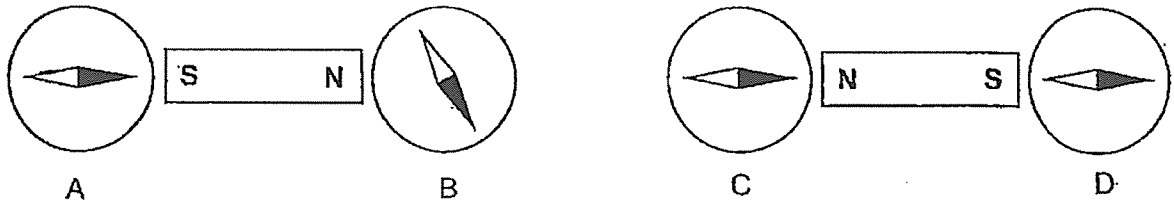

Which compass was working?

- (1) A
- (2) B
- (3) C
- (4) D

20. Linda wanted to find out if the number of batteries ~~around a nail~~ affects the magnetic strength of an electromagnet.

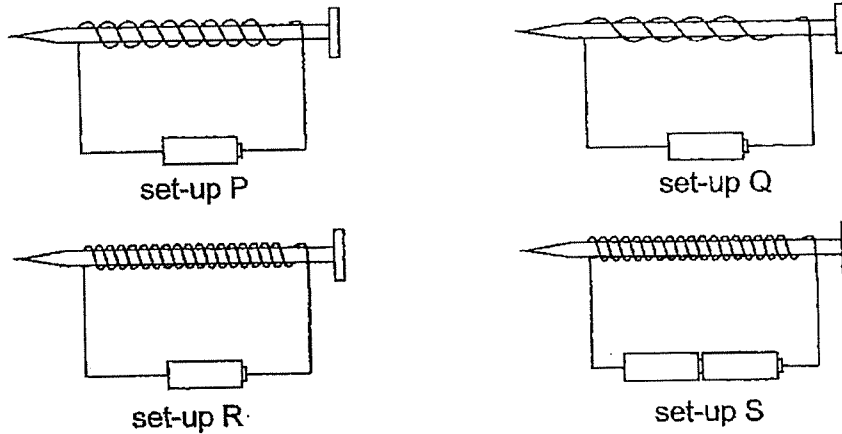

Which of the following set-ups should she choose to conduct a fair test?

- (1) P and Q
 - (2) P and S
 - (3) R and S
 - (4) Q and R
21. An air mattress is fully inflated but Esther is still able to pump more air into it.

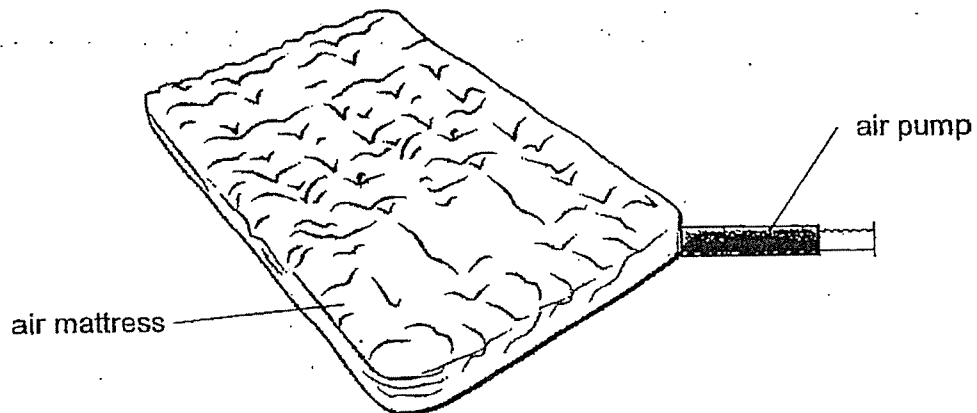

Why is this possible?

- (1) Air has mass.
- (2) Air takes up space.
- (3) Air has no definite shape.
- (4) Air has no definite volume.

22. Wayne was walking along a street from point A to point D as shown below.

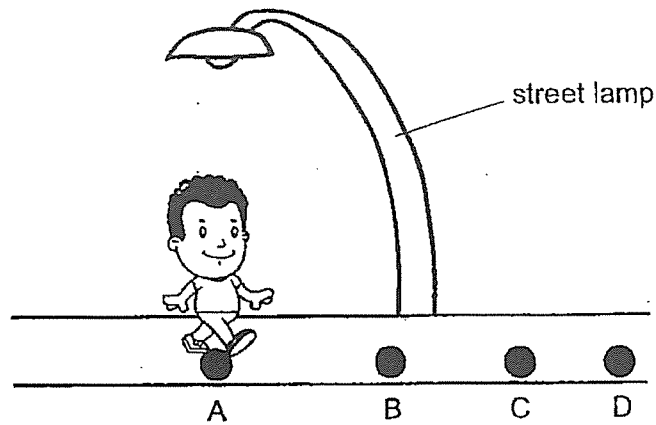

If the street lamp is the only source of light, at which point will his shadow be the shortest?

- (1) A
- (2) B
- (3) C
- (4) D

23. Ben moulded some clay into a big square block. He then cut the clay into six equal pieces as shown below.

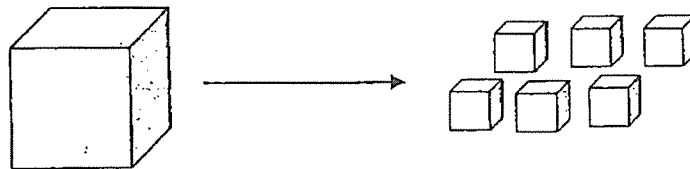

Which of the following is true about the total mass and volume of the six pieces of clay?

	Total Mass	Total Volume
(1)	increases	decreases
(2)	remains the same	increases
(3)	decreases	remains the same
(4)	remains the same	remains the same

24. When Muthu was standing behind the wall as shown below, he could not see the stool.

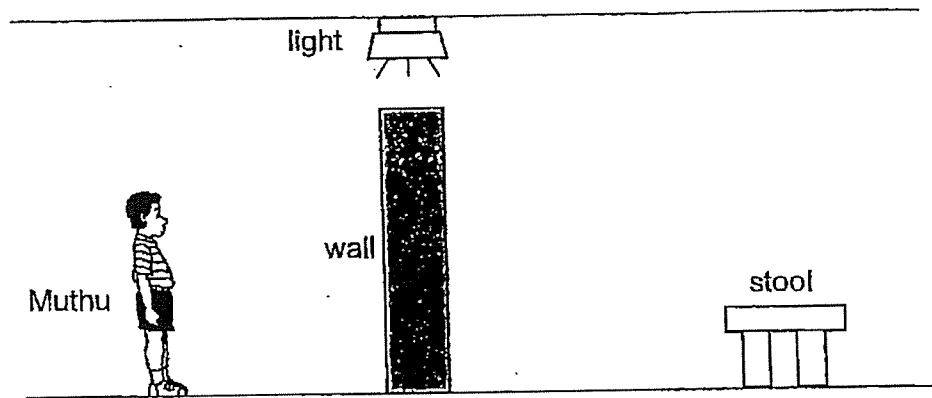

Which one of the following was the reason why Muthu could not see the stool?

- (1) The stool did not reflect light.
- (2) The stool did not give off light.
- (3) The wall did not allow light to pass through.
- (4) The stool did not allow light to pass through.

25. The diagram below shows two metal objects, S and T.

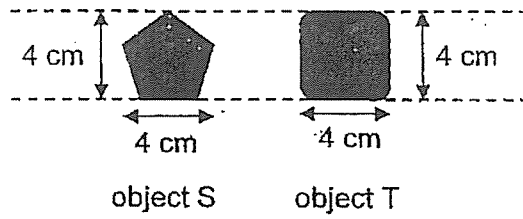

A shadow was formed on the screen when objects S and T were arranged as shown below.

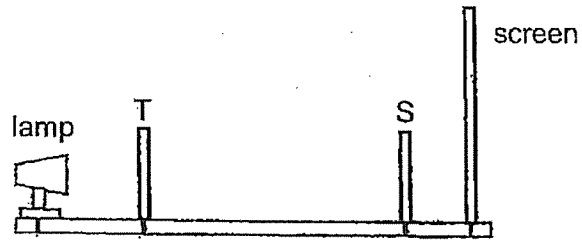

Which one of the following correctly shows the shadow formed on the screen?

(1)

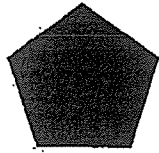

(2)



(3)



(4)



26. Marissa conducted an experiment in a dark room using the set-up below. A shadow of the doll was observed on the screen.

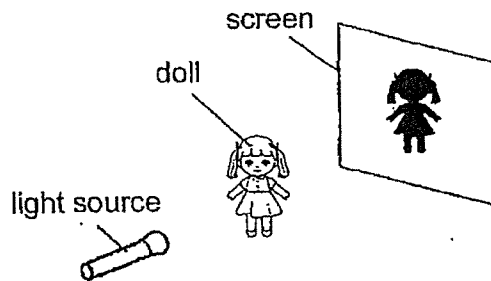

Which one of the following is correct if she wants to get a bigger shadow?

- (1) Move the doll nearer to the screen
- (2) Move the doll nearer to the light source
- (3) Move the screen nearer to the light source
- (4) Move the light source further away from the doll

27. The ring and the ball shown below were made of the same material.

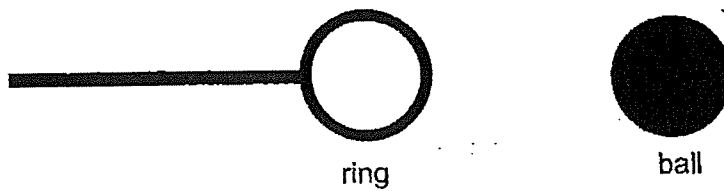

At room temperature, the ball was unable to pass through the ring. After heating the ring for a while, the ball passed through the ring.

Which of the following explains this observation?

	The ring	The ball
(1)	expanded	contracted
(2)	expanded	remained the same size
(3)	remained the same size	contracted
(4)	remained the same size	remained the same size

28. Aziz conducted an experiment using the set-up below.

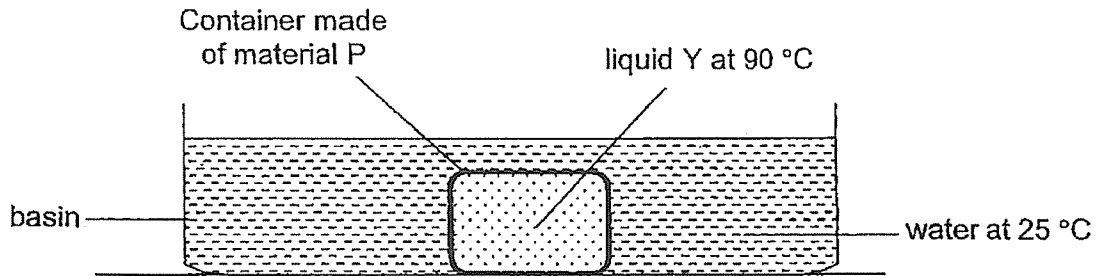

He measured the temperature of liquid Y in the container over a period of time. He repeated the experiment using container made of material Q. His results are shown in the graph below.

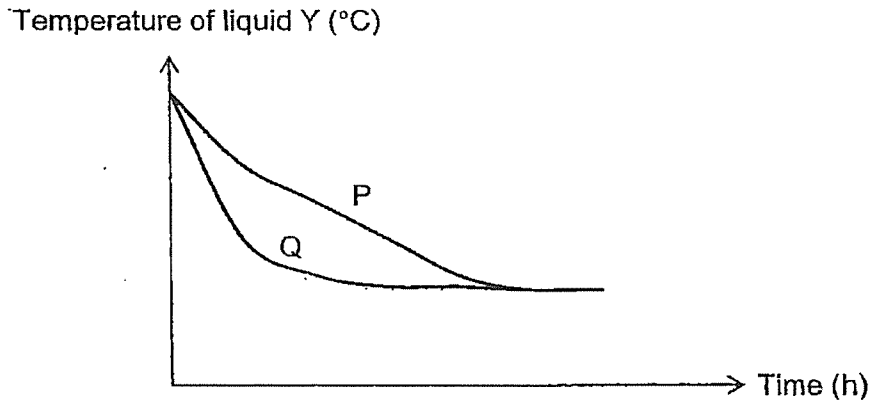

Aziz wanted to bring hot food and cold drinks for a school trip. He wanted to keep the food hot and the drinks cold. Which material(s) would be more suitable for the containers?

		Material for container carrying	
		hot food	cold drinks
(1)		P	P
(2)		P	Q
(3)		Q	P
(4)		Q	Q

END OF BOOKLET A

SECTION B: 44 Marks

For questions 29 to 40, write your answers in the spaces provided.
The number of marks available is shown in brackets [] at the end of each question or part question.

29. Draw lines to match the following animals to the correct groups. [3]

Animals

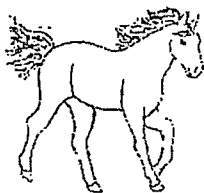
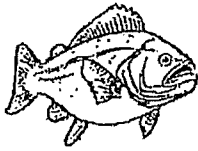

Groups

● mammal

● fish

● reptile

● bird

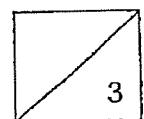

30. Jamal has four pictures, A, B, C and D, which show the different stages in the life cycle of a butterfly.

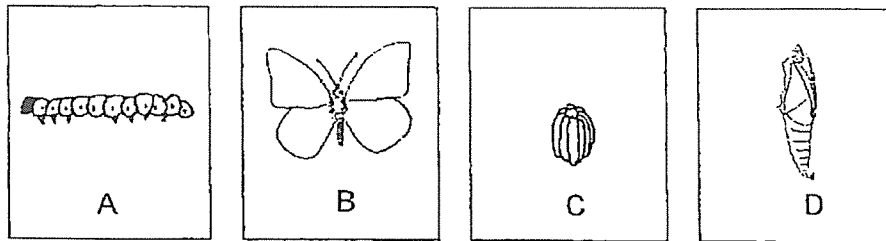

- (a) Arrange A, B, C and D in the correct order of the life cycle starting from C. [1]

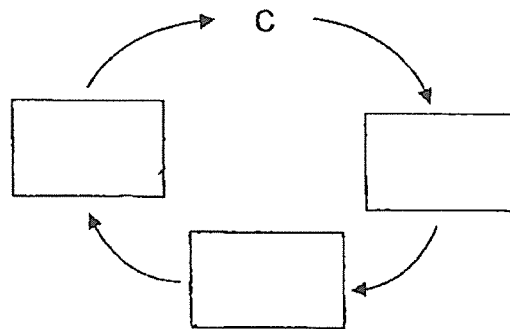

- (b) Name stage D: _____ [1]

- (c) State one other animal that has a similar life cycle as a butterfly. [1]

31. Two magnets are placed together as shown below.

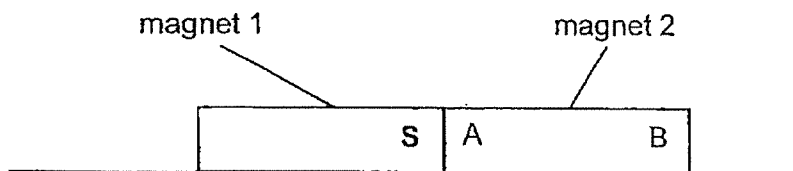

The south pole of magnet 1 is labelled S.

Name the poles labelled A and B on magnet 2. [2]

A: _____

B: _____

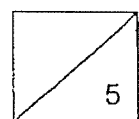

32. Rui Qi shines a torch on a ball and a shadow is formed on a smooth screen.

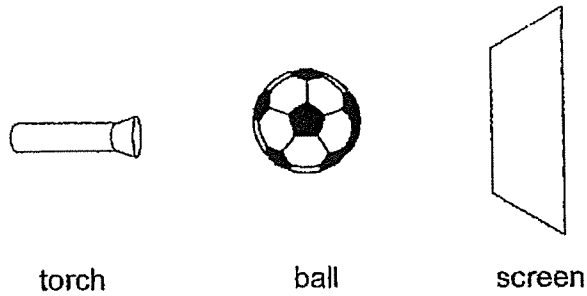

(a) Draw the shadow of the ball that is formed on the screen. [1]

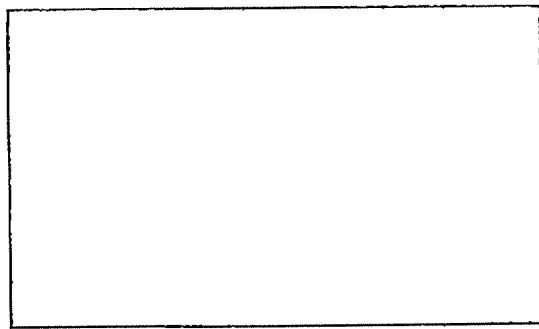

(b) A shadow is formed when light is _____ by an object. [1]

Rui Qi replaces the ball with a soft drink can.

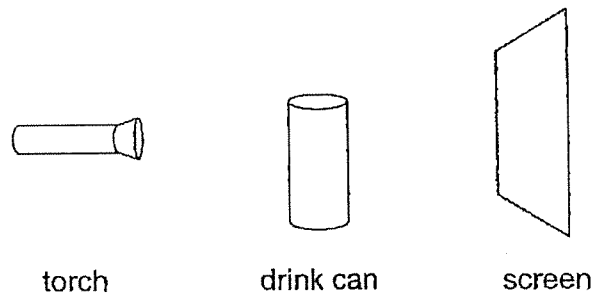

(c) Tick (✓) the shape of shadow that Rui Qi will now see on the screen. [1]

circle

square

rectangle

triangle

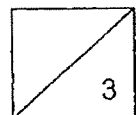

33. Anna grew a young seedling as shown below.

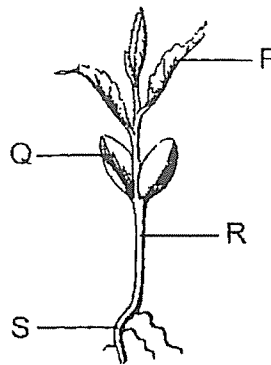

(a) Which part of the seedling P, Q, R or S, grew first? [1]

(b) Other than measuring the height of the seedling, state another method to measure the growth of the seedling. [1]

(c) Green leaves appeared on the shoot a few days later. Explain what would happen to the plant if Anna kept it in a dark room. [1]

(d) Anna wanted to find out if water is needed for plants to grow. Which of the following variables should be changed so that the experiment would be a fair test?

Put a tick (✓) next to the variable that needs to be changed. [1]

Variables	Tick (✓)
Type of plant	
Height of the plant	
Location of the plant	
Amount of water given to each plant	

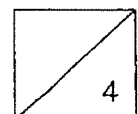

34. Mdm Jannah prepared a bottle of milk for her baby. However, it was too hot. She placed the bottle of milk into a basin of water at room temperature of $28\text{ }^{\circ}\text{C}$, as shown in the diagram below.

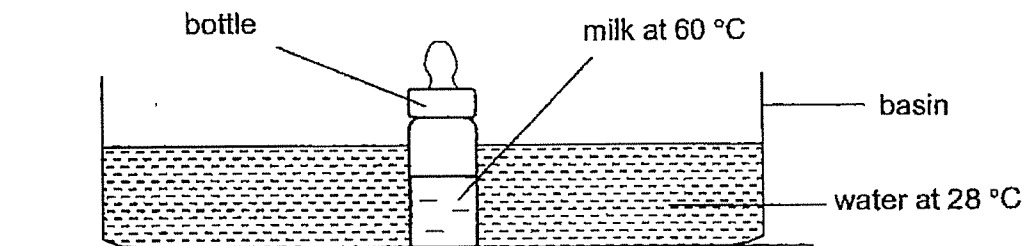

- (a) What will happen to the temperature of the water after 3 minutes?

Circle the correct answer.

[1]

The temperature of the water (*decreases* / *stays the same* / *increases*).

- (b) Explain your answer in (a).

[1]

- (c) What will happen to the temperature of the milk if Mdm Jannah leaves it there for four hours? Explain your answer.

[2]

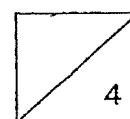

35. Janet wanted to find out how the size of the food substance X affects the time taken for it to be completely digested.

The same amount of food substance X of different sizes were placed in a test tube with equal amount of digestive juice.

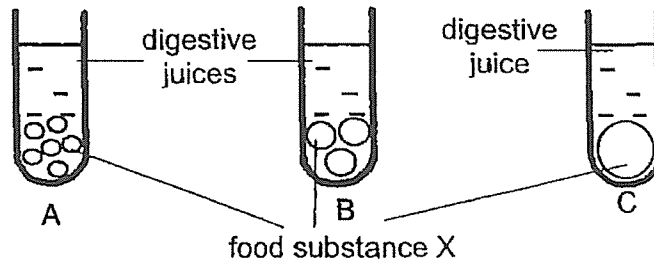

Janet recorded her results in the table below.

Set-up	Time taken for food substance X to be completely digested (min)
A	9
B	23
C	42

- (a) State what digestion is. [1]

- (b) Based on the results, what is the relationship between the size of food substance and the time taken for the food substance to be completely digested? [1]

- (c) Based on the experiment, explain how chewing helps in the digestion process. [1]

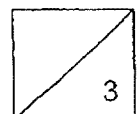

36. Bijay conducted an experiment by putting similar blocks of different masses onto three materials, F, G and H.

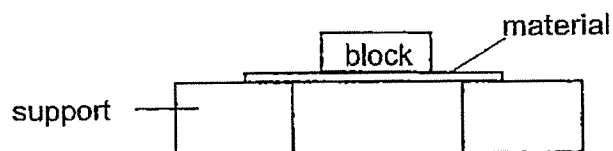

She recorded the mass of blocks that each material could hold before breaking in the table below.

Material	Mass it could hold before breaking (kg)
F	1
G	6
H	4

- (a) State the property of material that Bijay was testing. [1]

She then set up another experiment with strips of materials F, G and H. For each strip, she measured the distance d when a block of 300 g was placed on the strip.

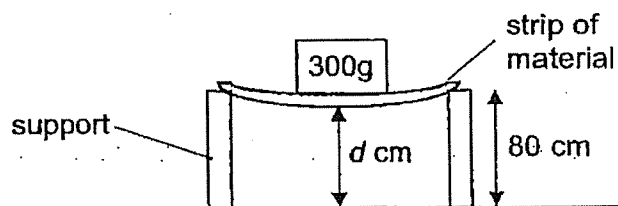

The results are shown below.

Material	d (cm)
F	38
G	80
H	69

- (b) Based on the above results, what property of the material was Bijay testing? [1]

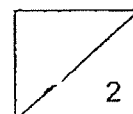

Bijay wanted to choose a material to make a 'selfie' stick to hold a phone camera to take photographs

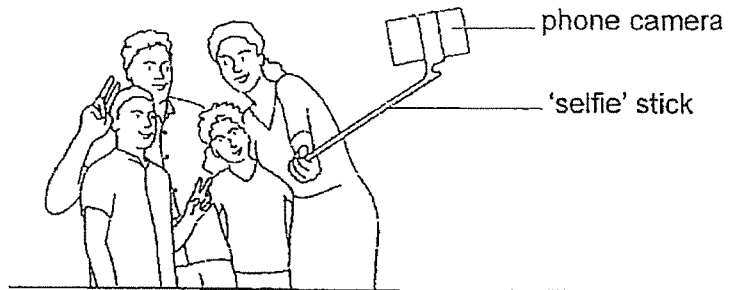

- (c) Based on the results of her second experiment, which material, F, G or H is most suitable for making the 'selfie' stick? Explain your answer. [1]

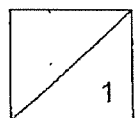

37. Lucy placed rod M under a bar magnet that she hung from a spring as shown in the set-up below.

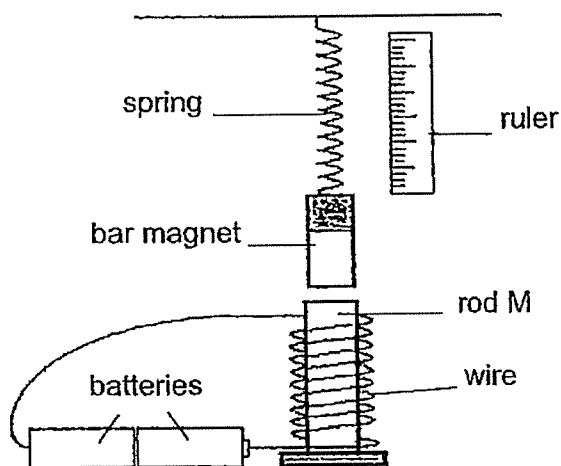

Fill in the blank.

- (a) The rod M has become a/an _____ . [1]

- (b) Explain why the length of the spring decreased when rod M was placed under the bar magnet. [1]

- (c) Name a material rod M could be made of. [1]

- (d) Using the same materials in the above set-up, suggest **two** changes Lucy can make that would cause a greater decrease in the length of the spring. [2]

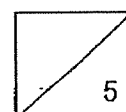

38. Meiling poured 100ml of water into four different containers of different shapes and sizes as shown below.

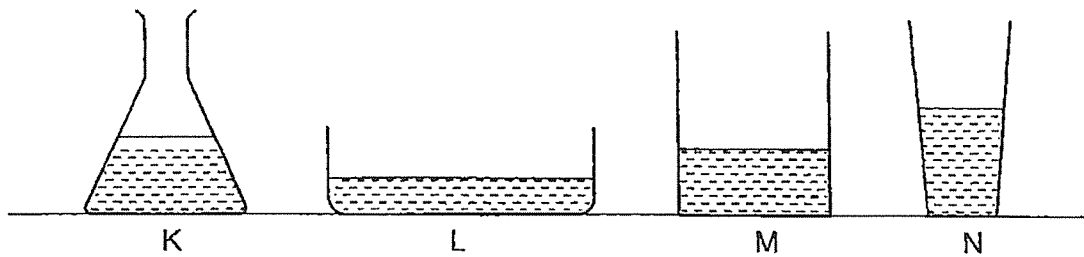

- (a) Besides taking up space, state another property of water based on the observation above. [1]

Meiling then poured all the water into the container below. She observed that the water level in the arms were different.

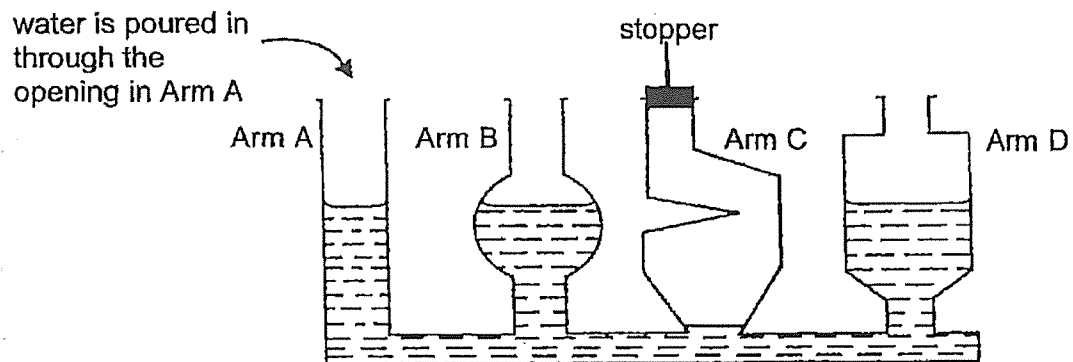

- (b) Explain why the water level in Arm C is lower than the water levels in Arms A, B and D of the connecting container. [1]

-
- (c) Suggest a way to make the water levels the same in all the arms. [1]

-
- (d) How would your suggestion in (c) affect the water level in other arms? [1]

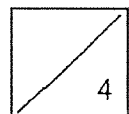

39. Alice wanted to find out the volume of the air in a container. She filled it to the brim with 250cm^3 of pebbles.

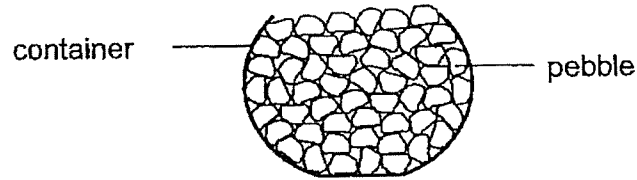

- (a) Tick (✓) the box that shows the most likely volume of the container. [1]

Volume of Container	Tick (✓) the correct volume
Less than 250cm^3	
Is equal to 250cm^3	
More than 250cm^3	

- (b) Explain your answer in part (a). [1]

- (c) Alice's teacher then gave her water and a measuring cylinder. Re-order the steps by filling in 1, 2 and 3 below so that Alice could get a more accurate measurement of the volume of the air in the container. [1]

Steps to be taken	Sequence of steps
Remove all the stones in the container.	
Use a measuring cylinder to measure the volume of the water in the container.	
Fill up the container of stones with water.	

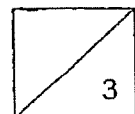

40. An object R was placed in a black sealed box with a small hole at the side.

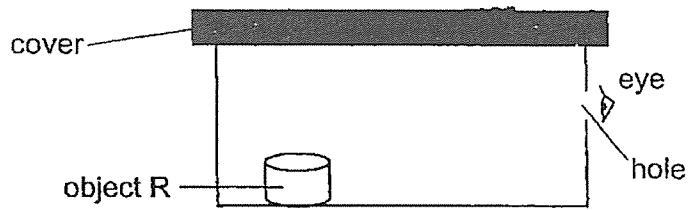

Nora looked through the hole in the box to see what object R was.

(a) Explain why Nora will not be able to see object R. [1]

(b) Without making changes to the sealed box, what can she do so that she can see object R in the box? [1]

Nora's father was driving his car at night, along a road with no street lamps. Reflective strips on the road helped him to see the road in the dark from a distance.

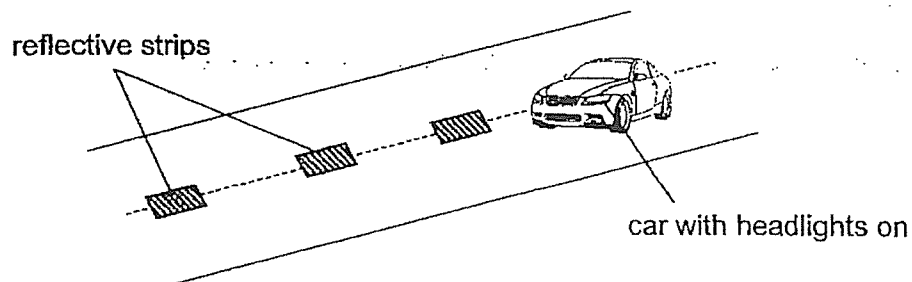

(c) Explain how Nora's father was able to see the reflective strips when he turned on his car's headlights. [1]

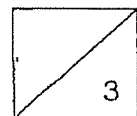

41. Percy set up an experiment using two identical glass flasks, P and Q, connected by a glass tube which contains a drop of ink as shown below.

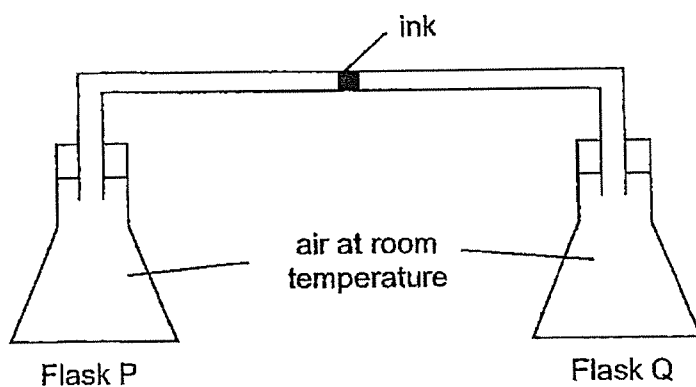

- (a) What would happen to the drop of ink in the glass tube after flask Q is placed in iced water for five minutes? [1]
-

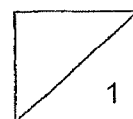

Percy then placed four rods made of different materials, R, S, T and U, into a container of hot water as shown below.

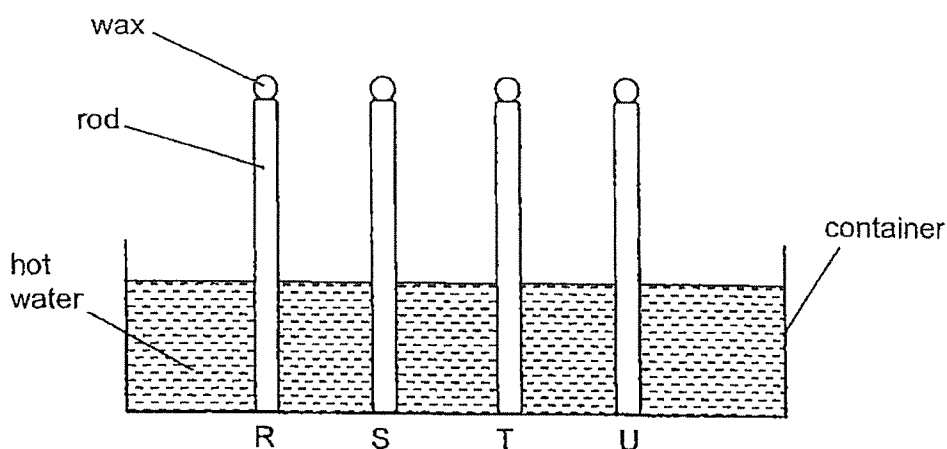

The rods had the same amount of wax on top of it. He recorded the time taken for each wax to melt completely on the rod in the table as shown below.

Material of rod	Time taken for the wax to melt completely (min)
R	10
S	2
T	15
U	8

- (b) Explain how the wax melted. [1]

Percy wanted to make a mug holder so that his hands would not feel warm whenever he held his mug filled with hot drinks.

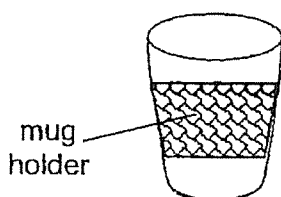

- (c) Based on the results table, which material, R, S, T or U, should Percy use to make the mug holder? Explain your answer. [2]

END OF BOOKLET B



SCHOOL : PAYA LEBAR PRIMARY SCHOOL
 LEVEL : PRIMARY 4
 SUBJECT : SCIENCE
 TERM : 2023 SA2

SECTION A

Q 1	Q2	Q3	Q4	Q5	Q6	Q7	Q8	Q9	Q10
2	4	3	3	3	1	2	4	4	1
Q 11	Q12	Q13	Q14	Q15	Q16	Q17	Q18	Q19	Q20
3	2	2	1	3	2	1	2	1	3
Q 21	Q22	Q23	Q24	Q25	Q26	Q27	Q28		
4	1	4	3	4	2	2	1		

SECTION B

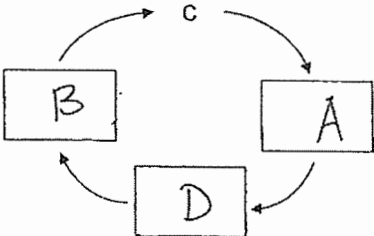
Q29)	<p>Animals</p>  <p>Groups</p> <ul style="list-style-type: none"> • mammal • fish • reptile • bird <p>Hand-drawn lines connect the fish to 'fish', the penguin to 'mammal', and the horse to 'mammal'.</p>
Q30)	 <p>a) b) Name stage D: Pupa c) Mosquito</p>
Q31)	<p>A: North B: South</p>

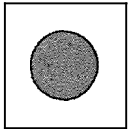
Q32)	 <p>a)</p> <p>b) A shadow is formed when light is blocked by an object</p> <p>c) Rectangle</p>
Q33)	<p>a) S</p> <p>b) Anna could measure the number of leaves</p> <p>c) Plant will die as leaves are unable to trap any sunlight to make food to survive and seed leaf will have dropped off</p> <p>d) Amount of water given to each plant</p>
Q34)	<p>a) Circle * Increases</p> <p>b) The water gained heat from the bottle of milk</p> <p>c) The temperature of milk will be at room temperature as heat flows from hotter region to colder region.</p>
Q35)	<p>a) Digestion is the process of breaking down food into simpler substances and absorbing the food into the bloodstream</p> <p>b) The smaller the size of food substance X, the shorter the time taken for food substance to be completely digested</p> <p>c) Chewing breaks down food into smaller pieces, decreasing time taken for the food to be completely digested</p>
Q36)	<p>a) Strength</p> <p>b) Flexibility</p> <p>c) G. When the 300g weight was placed on it, G did not bend. Material G is not flexible and can hold the phone camera up so that it does not shake when taking photographs</p>
Q37)	<p>a) Rod M has become an electromagnet</p> <p>b) The like poles of rod M and the bar magnet were facing each other, causing them to repel each other</p>
Q38)	<p>a) Water does not have a definite shape</p> <p>b) Air trapped inside arm C cannot escape and is taking up most of the space in Arm C so water cannot flow in Arm C to occupy the space the air is taking up.</p> <p>c) Remove the stopper at Arm C</p> <p>d) The water level in other arms will decrease</p>
Q39)	<p>a) More than 250cm³</p> <p>b) There are air spaces in between the pebbles and air take up space</p>

	c) 2, 3, 1
Q40)	<p>a) There is no light source in the sealed box for object R to reflect light into Nora's eyes and light enables us to see</p> <p>b) Nora can add a lighted torch into the box</p> <p>c) The reflective strips on the road reflected light from Nora's father's car's headlights into Nora's father's eyes, allowing Nora's father to see the road in the dark from a distance</p>
Q41)	<p>a) The drop of ink moves towards flask Q</p> <p>b) The rods conducted heat from the hot water to the wax, letting the wax gain heat and melt.</p> <p>c) T, it took the longest time for wax on top to drop, showing that it is the poorest conductor of heat so it will not gain heat from the hot drink easily, hence not letting Percy's hand feel warm whenever he holds his mug with hot drinks.</p>

