

Anglo-Chinese School (Junior)



END-OF-YEAR EXAMINATION (2023)

PRIMARY 4
SCIENCE
BOOKLET A

27 October 2023

Total Time for Booklet A and Booklet B : 1 h 45 min

Name: _____ () Class: 4.()

INSTRUCTIONS TO CANDIDATES

1. Do not turn over this page until you are told to do so.
2. Follow all instructions carefully.
3. Answer all questions.
4. Use a 2B pencil to shade your answers on the Optical Answer Sheet (OAS).

This booklet consists of 17 printed pages.

For each question from 1 to 28, four options are given. One of them is the correct answer. Make your choice (1, 2, 3 or 4). Shade your answer on the Optical Answer Sheet.

(56 marks)

1. The table shows how some living things can be grouped.

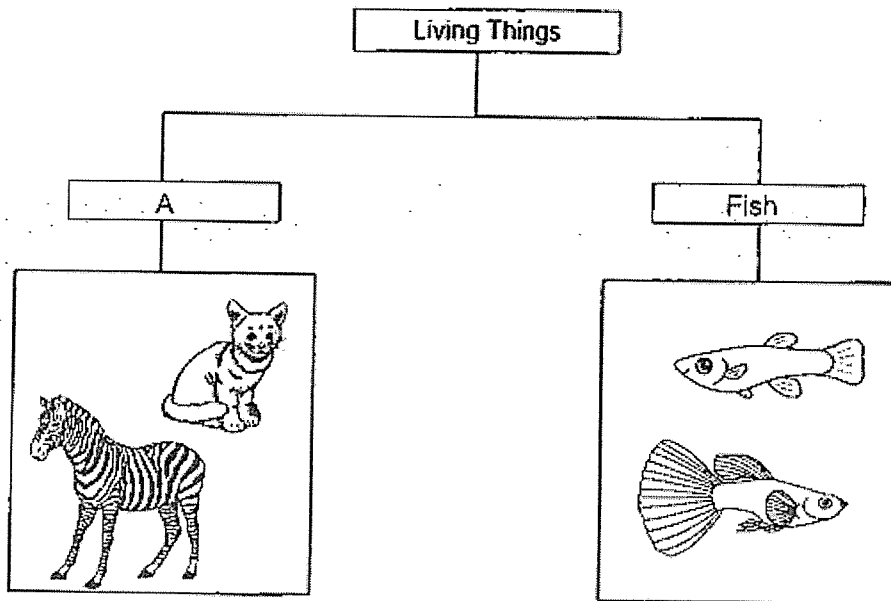

Which of the following is the most suitable heading for group A?

- (1) Birds
- (2) Insects
- (3) Mammals
- (4) Amphibians

2. Which animal is NOT a reptile?

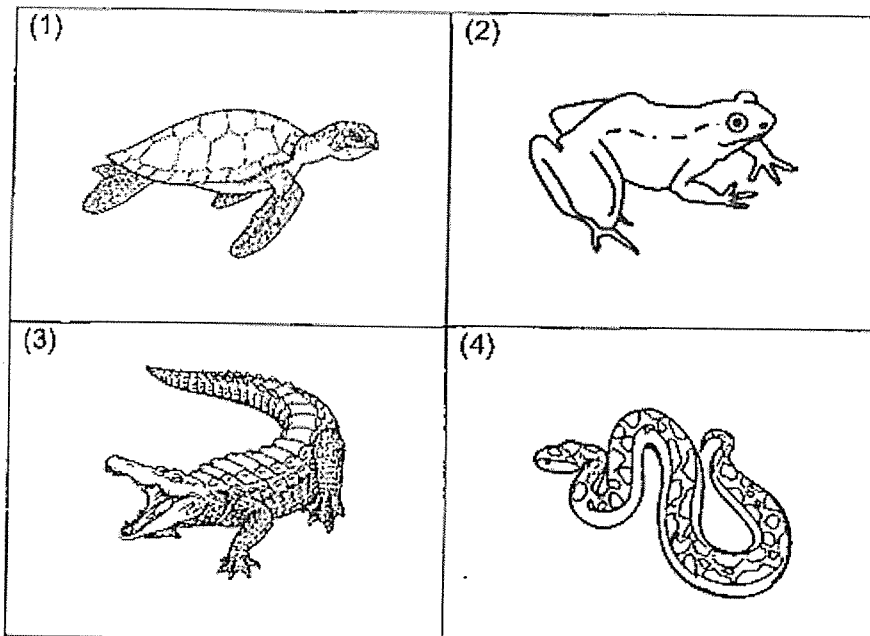

3. Which organ system is shown in the diagram?

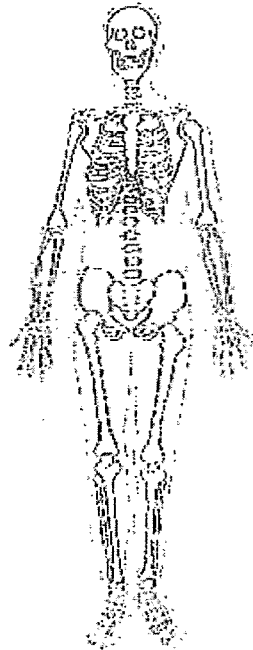

- (1) skeletal system
 - (2) muscular system
 - (3) circulatory system
 - (4) respiratory system
4. Which of the following is **NOT** a source of heat?
- (1) The Sun
 - (2) A lighted lamp
 - (3) A candle flame
 - (4) A woollen jacket

5. Which part, (1), (2), (3) or (4), supports the plant?

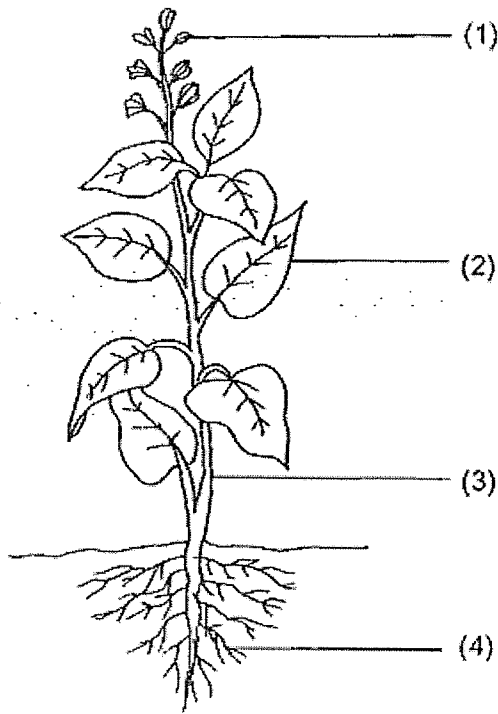

6. Which animal has a 4-stage life cycle?

(1)

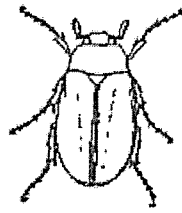

beetle

(2)



chicken

(3)

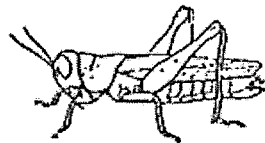

grasshopper

(4)







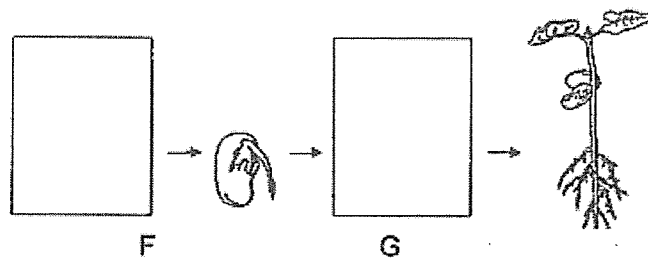



frog

7. The diagram shows the growth of a young plant with two missing stages, F and G.



Which of the following shows the correct stages for F and G?

	F	G
(1)		
(2)		
(3)		
(4)		

8. A magnet was brought near a plastic block as shown.



What will happen to the plastic block?

- (1) It will move up.
- (2) It will not move.
- (3) It will move to the left.
- (4) It will move to the right.

9. Which of the following is a source of light?

(1) a flower

(2) a star in the sky

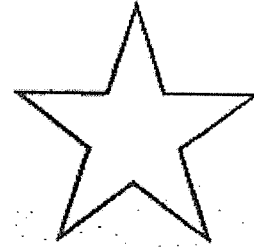
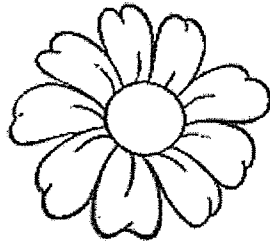

(3) the moon

(4) an apple

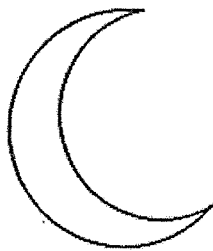

10. Danny places a metal spoon in a cup of hot coffee.

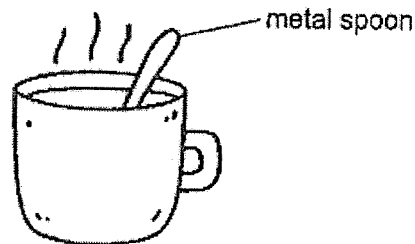

a cup of hot coffee

The spoon becomes hot after a while.

Which of the following explains this?

- (1) The cup loses heat to the hot coffee.
- (2) The spoon loses heat to the hot coffee.
- (3) The hot coffee gains heat from the spoon.
- (4) The spoon gains heat from the hot coffee.

11. Which of the following two statements correctly describe the circulatory system?

- A It absorbs digested food.
- B It breaks down food into simple substances.
- C It is made up of the heart, blood and blood vessels.
- D It works with the muscular system to remove air from the body.

- (1) A and B
- (2) A and C
- (3) B and C
- (4) B and D

12. The graph shows the number of days an insect remains at each stage of its life cycle.

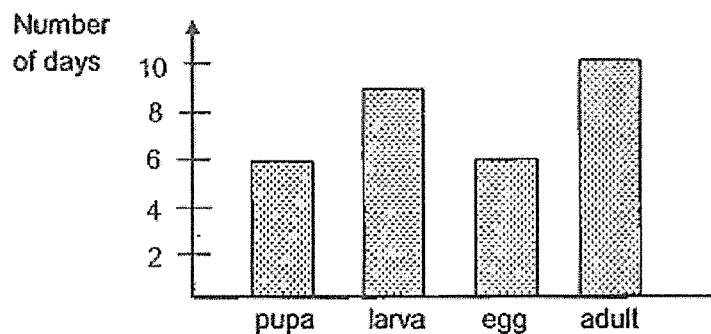

Which of the following conclusions can be made from the graph?

- (1) The pupa moults several times.
- (2) The insect is a pest to farmers for only 6 days.
- (3) The egg, larva and pupa live in water but the adult lives on land.
- (4) The insect takes 15 days to become an adult after the egg hatches.

13. The diagram shows the nymph and adult of a cockroach.

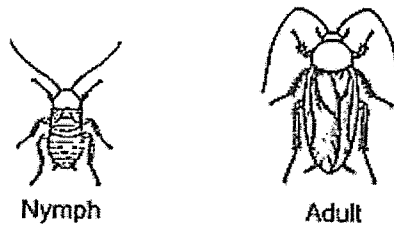

Which of the following statements are correct about them?

- A Both have feelers.
- B The nymph does not resemble the adult.
- C The nymph does not have wings but the adult has wings.
- D The nymph moults several times but the adult does not moult.

- (1) A and B only
- (2) C and D only
- (3) A, B and D only
- (4) A, C and D only

14. The diagrams show the life cycles of a chicken and a frog.

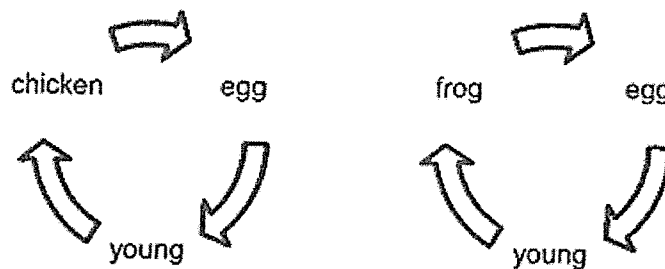

Which of the following describe the similarities between the two life cycles?

- A Both life cycles have three stages.
- B Both life cycles have an egg stage.
- C The young of both animals resemble the adult.
- D The young of both animals live both on land and in water.

- (1) A only
- (2) A and B only
- (3) C and D only
- (4) B, C and D only

15. Shanti investigated the conditions needed for the germination of green bean seeds. She prepared three set-ups, A, B and C, containing the same amount of cotton and the same number of green bean seeds.

A tick (✓) in the table indicates the condition present in each set-up.

Set-up	Condition		
	Light	Water	Air
A	✓	✓	
B		✓	✓
C	✓	✓	✓

She observed that the seeds in set-ups B and C germinated.

What can she conclude from her experiment?

- (1) Light is needed for germination.
 - (2) Only air is needed for germination.
 - (3) Water and air are needed for germination.
 - (4) The seeds in set-up B did not need warmth to germinate.
16. Helen wanted to find the volume of a stone. She poured some water in a measuring cylinder, and then placed the stone into the cylinder of water.

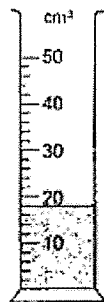

Before putting in the stone

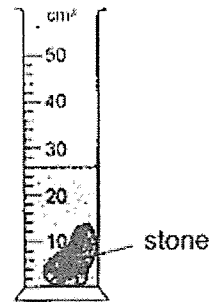

After putting in the stone

Which of the following statements is correct?

- (1) The mass of the stone is 26g.
- (2) The water displaced the stone.
- (3) The volume of the stone is 8cm³.
- (4) The stone takes up more space than the water.

17. The diagram shows four objects, A, B, C and D of different mass placed on a balance, two at a time.

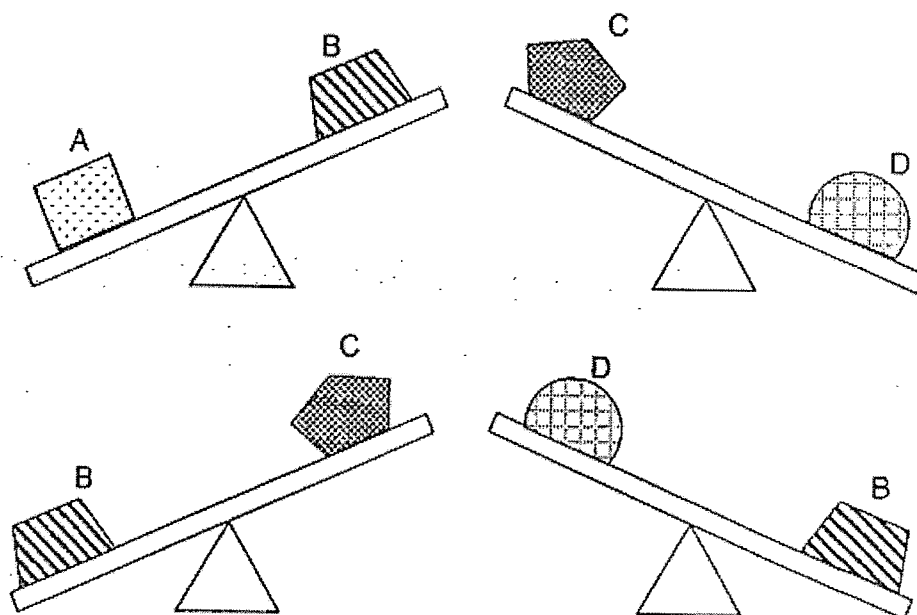

Which of the following correctly shows the mass of A, B, C and D from the greatest mass to the least mass?

	Greatest → Least			
(1)	A	B	D	C
(2)	A	C	B	D
(3)	C	D	B	A
(4)	D	A	B	C

18. Kamal filled a syringe with some water and sealed it. He observed that there was air in the syringe.

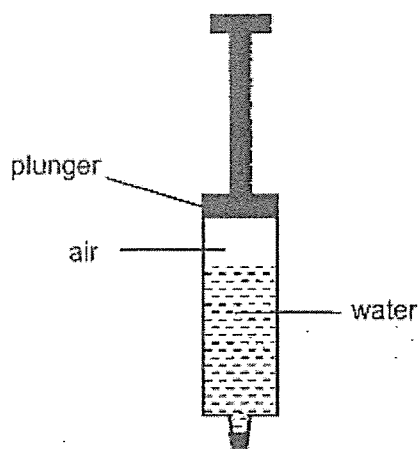

He pushed down the plunger of the syringe slightly. What will happen to the volumes of the water and air in the syringe?

	Volume (cm ³)	
	water	air
(1)	decrease	decrease
(2)	same	increase
(3)	same	decrease
(4)	increase	decrease

19. Jay set up an experiment as shown and observed how objects A and B interacted with magnet X.

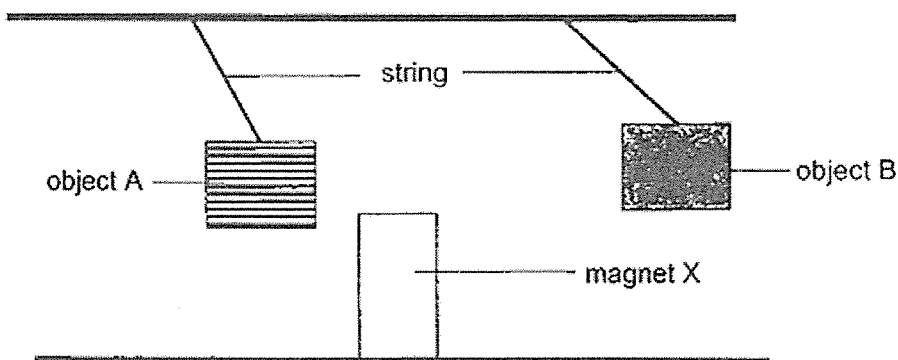

Which of the following is correct?

	Object A	Object B
(1)	magnetic material	non-magnetic material
(2)	magnetic material	magnet
(3)	magnet	non-magnetic material
(4)	non-magnetic material	magnet

20. Study the flow chart carefully.

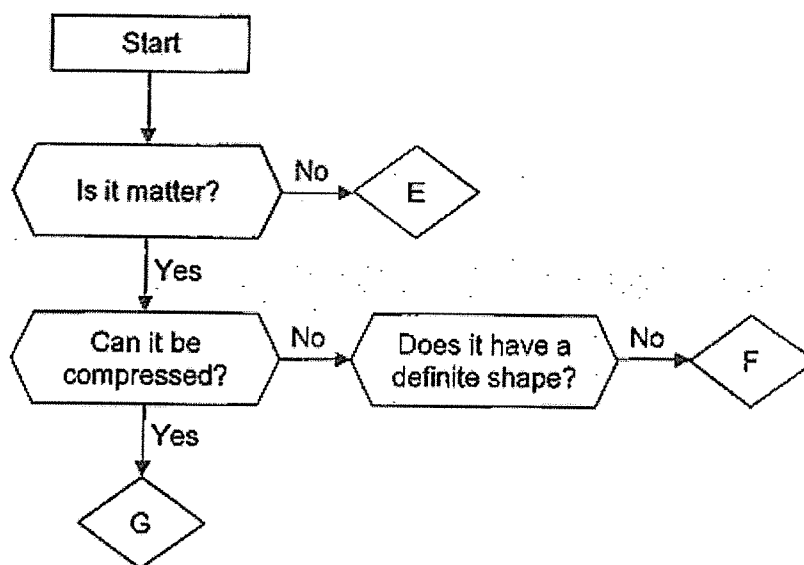

Which one of the following correctly identifies E, F and G?

	E	F	G
(1)	heat	juice	air
(2)	light	gas	juice
(3)	music	juice	light
(4)	air	music	gas

21. Four identical mugs each containing 300ml of water at different temperatures were left in the kitchen with a room temperature of 25°C.



Which of the following is most likely the temperature of the water in each mug after five minutes?

Temperature of water in the mug (°C)				
	Mug A	Mug B	Mug C	Mug D
(1)	20	20	20	25
(2)	30	30	30	30
(3)	50	40	30	25
(4)	70	40	20	20

22. Part X of four rods, P, Q, R and S, of identical size were placed one at a time next to a magnet as shown.

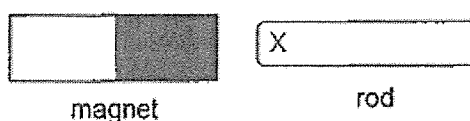

The interactions between the magnet and the rods were recorded in the table.

Rod	Attracted	Repelled	No interaction
P	✓		
Q		✓	
R			✓
S	✓		

Based on the results, which of the following conclusion(s) can be made?

- A Rod Q is a magnet.
- B Rod S is made of wood.
- C Rod R is made of a magnetic material.
- D Rods P, Q and S are magnetic materials.

- (1) B only
- (2) A and D only
- (3) B and C only
- (4) A, C and D only

23. A dark room was brightly lit when Ally turned on a torch on the table. She then placed a frosted glass jar over the lit torch. The room became less brightly lit.

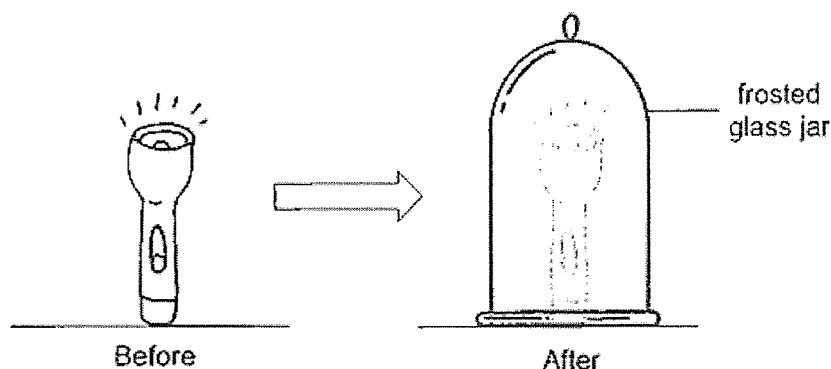

Which of the following explains why the room became less brightly lit?

- (1) Light from the torch is reflected into Ally's eyes.
- (2) No light is reflected from the torch into Ally's eyes.
- (3) The frosted glass jar blocks all light from the torch.
- (4) The frosted glass jar blocks some light from the torch.

24. Isa wants to find out how the number of batteries affects the strength of an electromagnet.

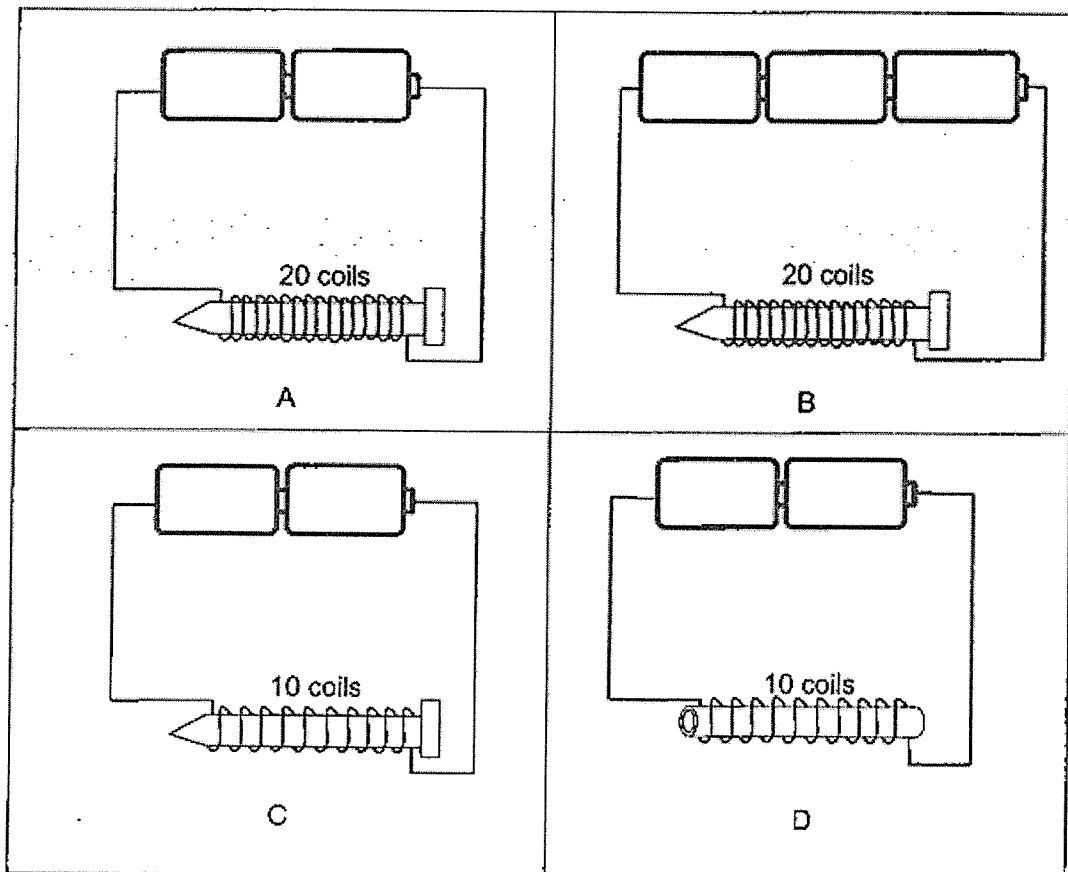

Which two set-ups should he use to test his aim?

- (1) A and B
- (2) A and C
- (3) B and C
- (4) C and D

25. Janet carried out an experiment with an iron nail and three magnets, X, Y and Z, of different sizes.

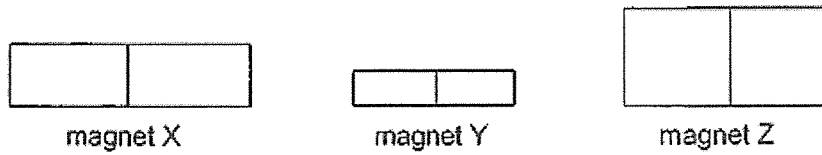

She moved magnet X towards the nail until the magnet attracted the nail.

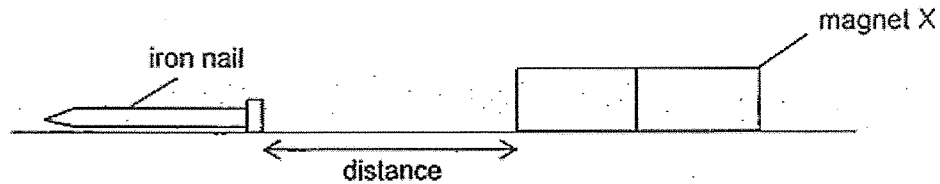

She then measured the distance between the nail and magnet X. She repeated the experiment with magnets Y and Z and recorded the results in the table.

Magnet	Distance (cm)
X	10
Y	5
Z	15

Based on her results, what could Janet conclude?

- (1) Magnet Z is the weakest magnet.
- (2) The bigger the magnet, the stronger it is.
- (3) The size of the magnet does not affect its strength.
- (4) Magnet X is stronger than magnet Z but weaker than magnet Y.

26. Sara wanted to find out how the different positions of a lighted torch affects the length of the shadow of a wooden ball. She prepared the set-up as shown and slowly moved the lighted torch from position A to C.

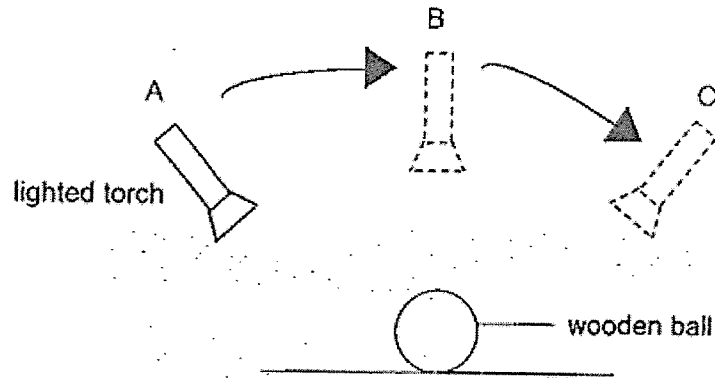

Which graph correctly shows the length of the shadow cast by the ball?

(1) Length of shadow

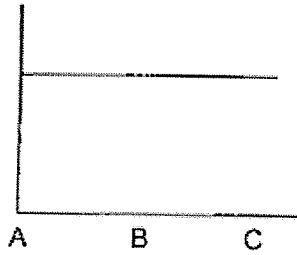

(2) Length of shadow

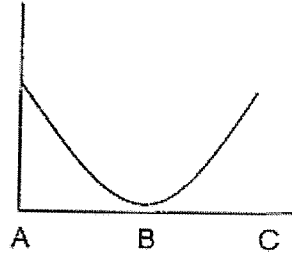

(3) Length of shadow

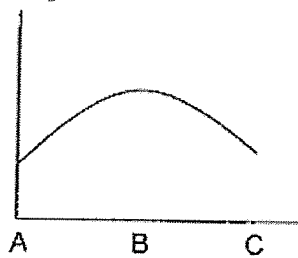

(4) Length of shadow

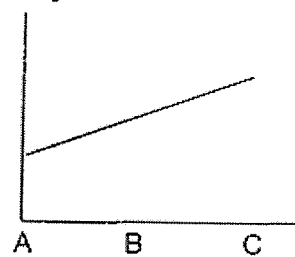

27. Anna used a hollow wooden tube to look at a flame.

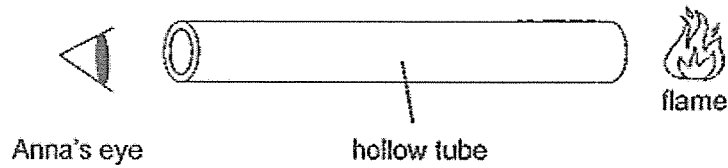

Which two statements explain why she was able to see the flame through the hollow wooden tube?

- A Light travels in a straight line.
- B Light from the flame enters her eyes.
- C Light is reflected away from her eyes.
- D Light from her eyes is reflected off the flame.

- (1) A and B
- (2) A and D
- (3) B and C
- (4) C and D

28. Laila noticed that there are gaps in the between the tiles on pavements.

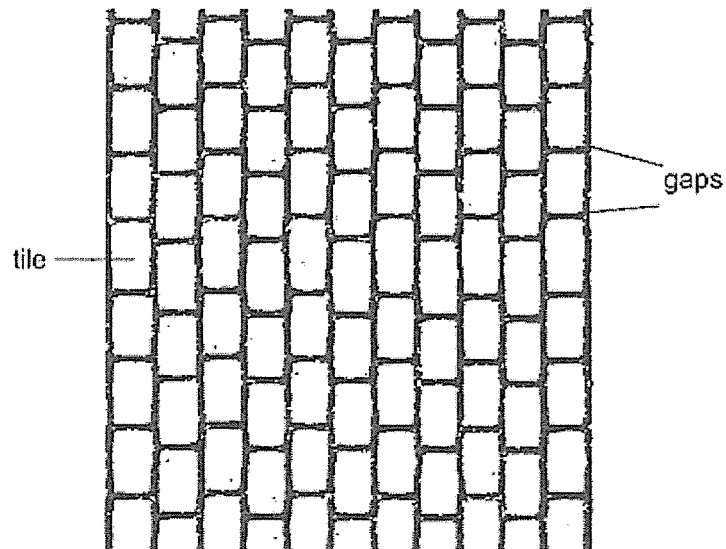

What would happen to the gaps on a hot day?

- (1) They will become larger.
- (2) They will become narrower.
- (3) They will expand more than the tiles.
- (4) They will gain heat from the surroundings.

End of Booklet A



Anglo-Chinese School (Junior)



END-OF-YEAR EXAMINATION (2023)

PRIMARY 4
SCIENCE
BOOKLET B

27 October 2023

Total Time for Booklet A and Booklet B : 1 h 45 min

Name: _____ () Class: 4.()

Parent's Signature: _____

INSTRUCTIONS TO CANDIDATES

1. Do not turn over this page until you are told to do so.
2. Follow all instructions carefully.
3. Answer all questions.

Booklet	Possible Marks	Marks Obtained
A	56	
B	44	
Total	100	

This question paper consists of 16 printed pages

For questions 29 to 41, write your answers in this booklet.
The number of marks available is shown in the brackets [] at the end of each question or part question.
(44 marks)

29. The diagram shows a window.

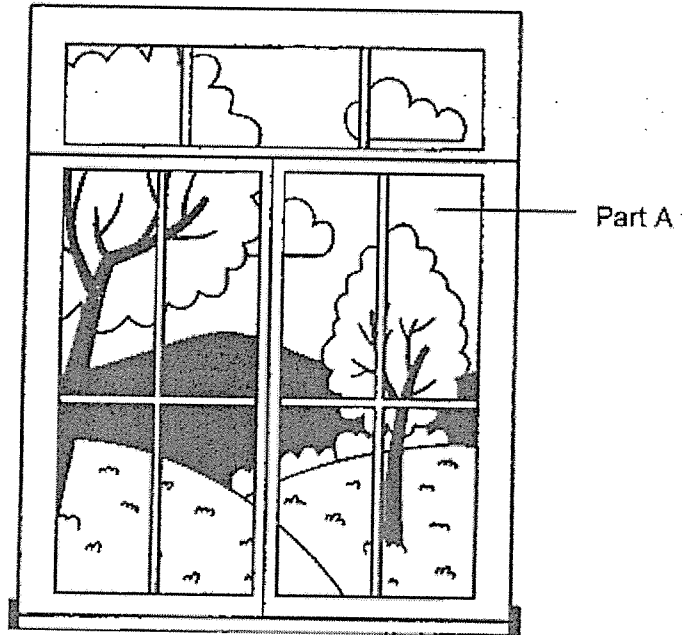

Fill in the blanks using the correct words in the box.

[3]

heat	breaks	metal
bends	light	glass

Part A is made of _____ because it allows _____

to pass through so that we can see the trees outside. However, part A

_____ easily when dropped.

(Go on to the next page)

SCORE	
	3

30. (a) The diagram shows part of the human digestive system. Tick (✓) one box to show where the large intestine is.

[1]

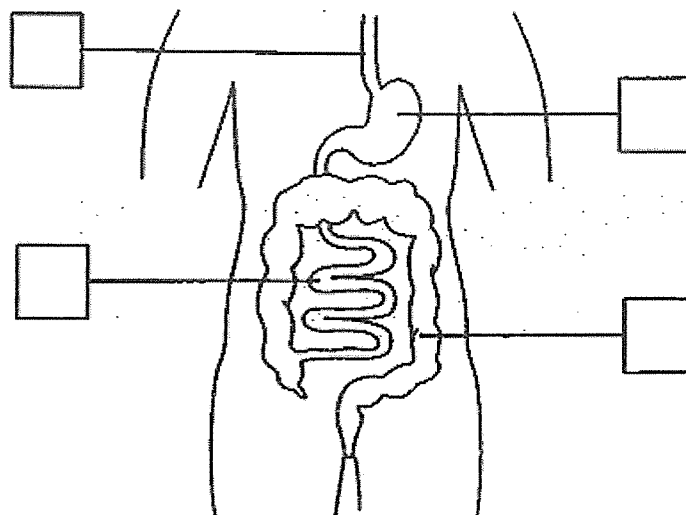

- (b) Fill in the blank using the following helping words.

[1]

gullet	mouth	large intestine	small intestine
--------	-------	-----------------	-----------------

Food from the stomach is next passed on to the _____

(Go on to the next page)

SCORE	2
-------	---

31. Tick (✓) in the box if each of the following has a definite shape and/or a definite volume. [3]

	Has definite shape	Has definite volume
(a) fruit juice	<input type="checkbox"/>	<input type="checkbox"/>
(b) air	<input type="checkbox"/>	<input type="checkbox"/>
(a) water bottle	<input type="checkbox"/>	<input type="checkbox"/>

32. Kayden placed two ring magnets, A and B, through a holder as shown.

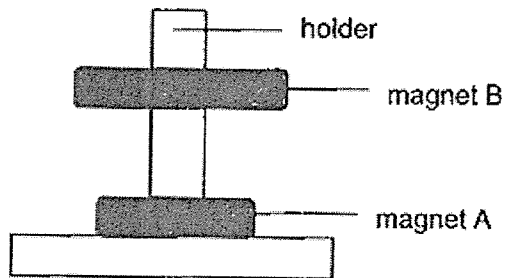

- (a) The holder was made of glass and did not attract the magnets. [1]

Glass is a _____ material.

- (b) Why was magnet B floating above magnet A? [1]

Magnet B was _____ magnet A.

(Go on to the next page)

SCORE	5
-------	---

33. (a) State what matter is.

[1]

Violet prepared a vase as shown.

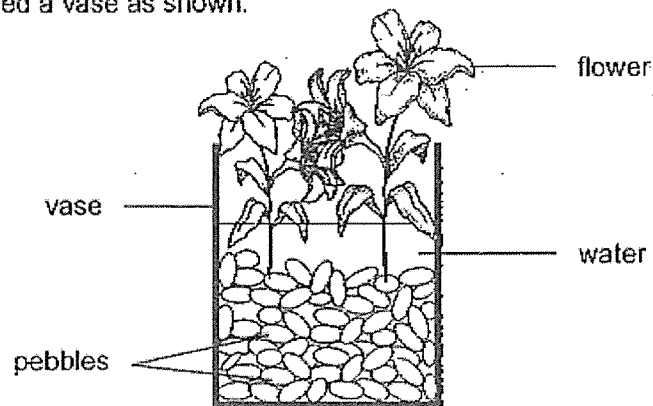

(b) Identify the state(s) of matter found in the vase.

[1]

(c) Violet added more pebbles to beautify the vase. Soon, the water in the vase overflowed. Explain why this happened based on the property of matter.

[2]

(Go on to the next page)

SCORE	4
-------	---

34. (a) State the stages in the life cycle of a mosquito by filling in the boxes.

[1]

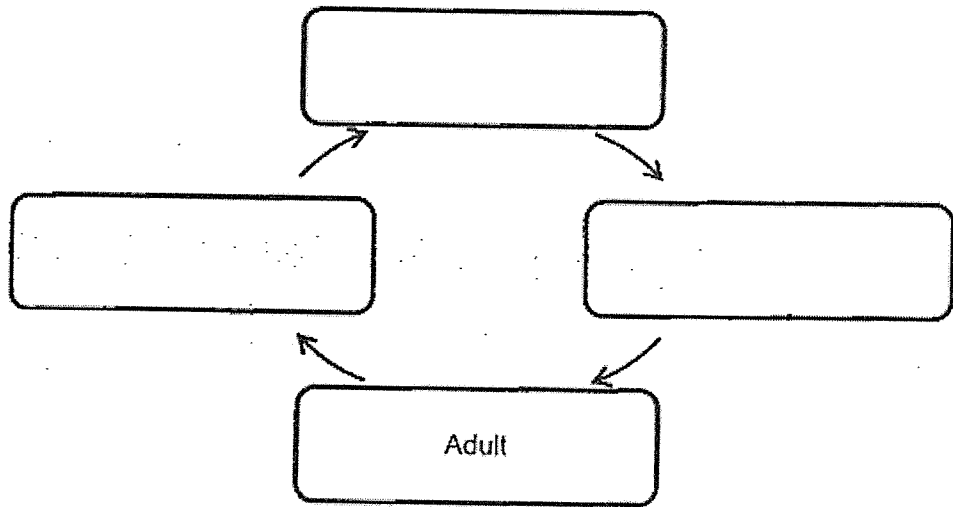

(b) Oil is sprayed on stagnant water as shown.

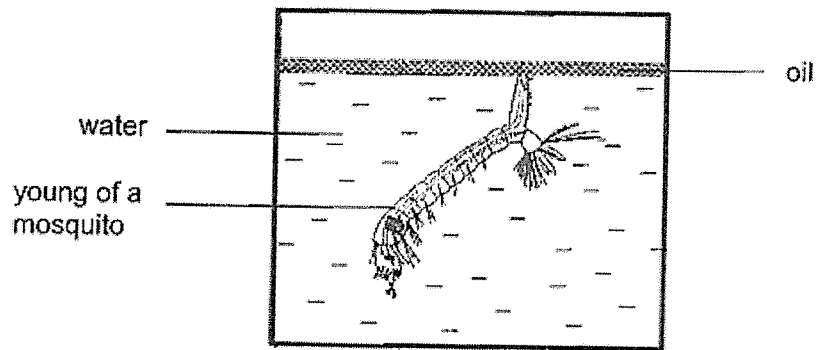

[2]

Explain how this prevents mosquitoes from breeding.

(Go on to the next page)

SCORE	
	3

- (c) A scientist wanted to find out the conditions that affect the life cycle of mosquitoes.

He set up an experiment by placing 30 eggs in a container of stagnant water. He recorded the number of mosquito eggs that hatched in a day at different temperatures.

Temperature of the surrounding (°C)	Numbers of eggs hatched in a day
22	18
25	23
28	28

State how the temperature of the surrounding affects the numbers of mosquito eggs hatched in a day.

[1]

(Go on to the next page)

SCORE	
-------	---

35. Chandra observed the growth of a seedling for one week.



- (a) He recorded his observations in a table.

Tick (✓) the boxes to indicate which of Chandra's observations are true and false. [1]

	Observation	True	False
(i)	The leaves allow the seedling to exchange gases.		
(ii)	The shoot grew before the roots.		
(iii)	The roots absorb water for the seedling.		

- (b) As the seedling grew, Chandra observed that the size of the seed leaves decreases. Explain why. [1]

- (c) The seedling died when Chandra cut away all its leaves. Explain why. [1]

(Go on to the next page)

SCORE	3
-------	---

36. Ayra made a temporary magnet using iron nail K with ends V and W as shown.

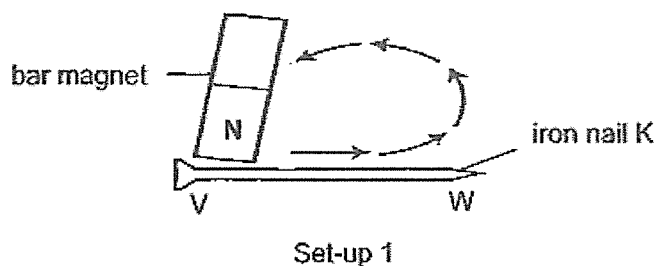

She found out that end-W is the South pole of the temporary magnet.

(a) Name the method Ayra used to make the temporary magnet. [1]

Ayra made another temporary magnet using iron bar L with ends X and Y.

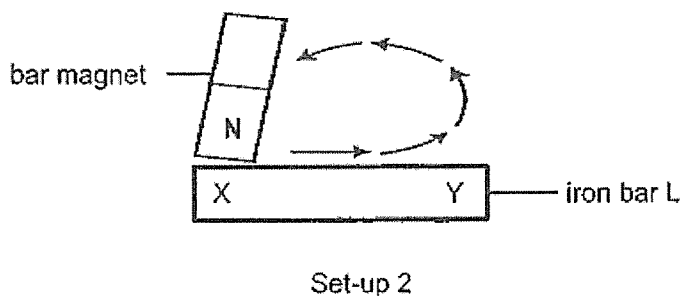

She brought the temporary magnet near a hanging magnet, Z, as shown.

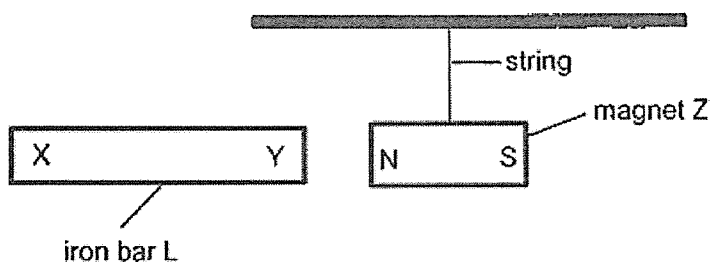

(b) How will iron bar L and magnet Z interact? Explain your answer. [2]

(Go on to the next page)

SCORE	3
-------	---

The diagram shows magnet Z after Ayra lifted it from a tray of metal paper clips.

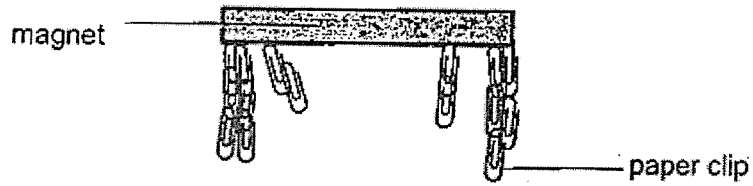

- (c) Based on her observation, what can she conclude about the ends of the magnet? [1]

37. Maria conducted an experiment with similar iron nails, wires and batteries in setups A and B as shown. The batteries are in working condition.

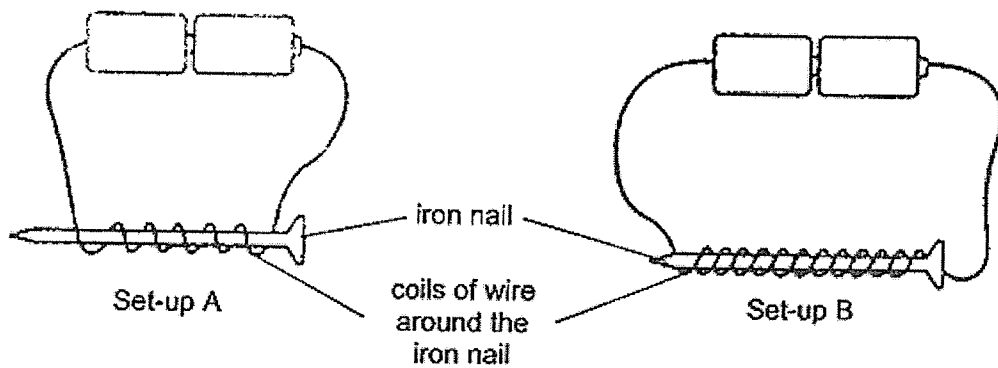

She placed the electromagnets near some steel pins and recorded the number of pins attracted to each electromagnet in the table.

Set-up	Number of steel pins attracted
A	3
B	5

- (a) State the aim of Maria's experiment. [1]

(Go on to the next page)

SCORE	2
-------	---

- (b) How can Maria attract more steel pins using set-up B without changing the number of batteries and the number of coils of wire around the iron nail? [1]

- (c) Maria wanted to find out if the number of batteries affects the magnetic strength of the electromagnet. State two changes she needs to make to set-up A to carry out her experiment. [1]

Change 1: _____

Change 2: _____

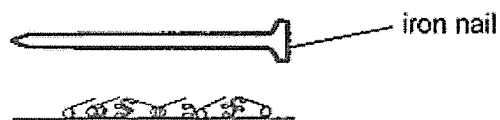

- (d) Maria removed the iron nail from set-up B. She found that the nail could not attract any steel pins. Give a reason why. [1]

(Go on to the next page)

SCORE	
	3

38. Joanne set up an experiment with three different liquids in a dark room as shown.

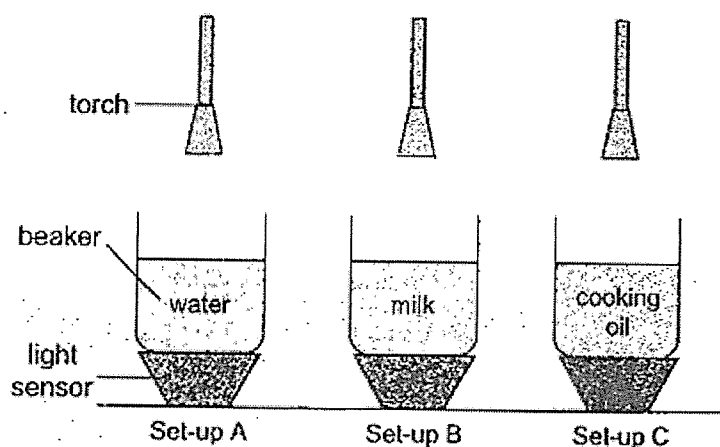

She used light sensors to measure the amount of light that passed through each beaker of liquid from the torches and recorded her results in the table.

Set-up	A	B	C
Amount of light (unit)	300	_____	150

- (a) State the amount of light that is most likely measured by the light sensor in set-up B in the table above. [1]
- (b) Based on Joanne's experiment, state a property of light. [1]
-
- (c) Tick(✓) the variables that must be kept constant for her to carry out a fair test. [1]

Variable	Tick (✓)
Type of liquid	
Type of beaker	
Type of light sensor	
Amount of light given off by the torch	
Amount of light measured by the light sensor	

- (d) Joanne added something to set-up A such that less light was detected by the light sensor. Suggest what she could have added and what she did with it. [1]
-
-

(Go on to the next page)

SCORE	4
-------	---

39. Umar set up an experiment to find out how the distance between a rubber ring and screen affects the size of the shadow formed on the screen.

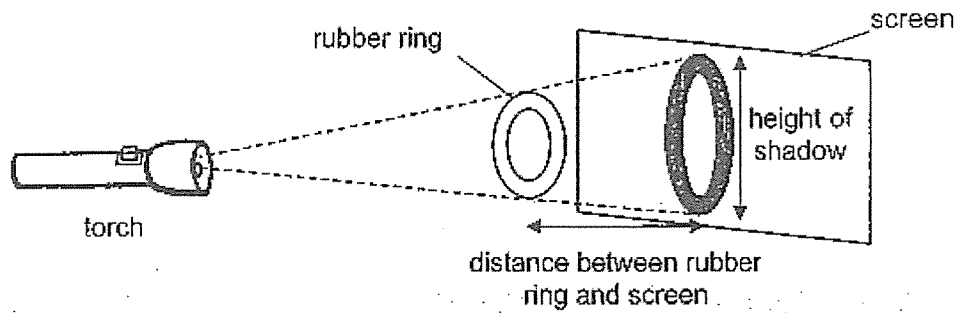

He changed the distance between the rubber ring and screen by moving the ring and recorded the height of the shadow formed in the table.

Distance between rubber ring and screen (cm)	Height of shadow (cm)
10	14
5	11
3	8

- (a) Based on the results of the experiment, what happens to the height of the shadow when the distance between the rubber ring and screen decreases? [1]

- (b) Without moving the rubber ring, state another way that Umar could increase the size of the shadow. [1]

- (c) Umar changed the rubber ring to a similar-sized ring made of another material. He noticed that the shadow formed on the screen was lighter. Give a reason why. [1]

(Go on to the next page)

SCORE	3
-------	---

40. Rani placed equal amounts of wax at the ends of three rods, made of different materials A, B and C. She then placed the rods at the same time into a container of boiling water as shown.

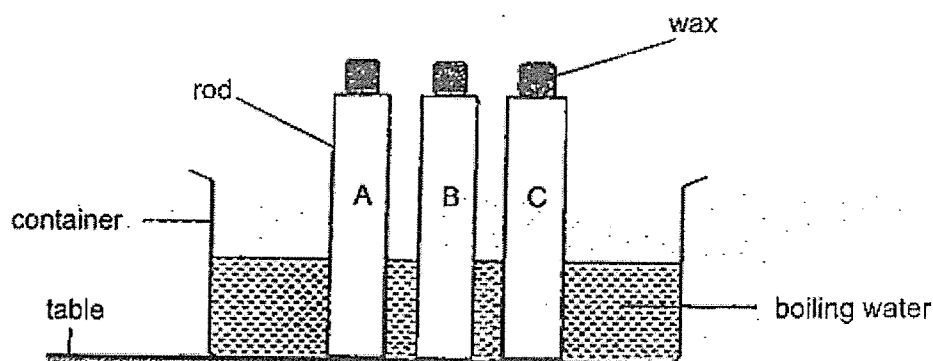

Rani recorded the time taken for the wax on each material to melt completely in the table.

Material	Time taken for the wax to melt completely (seconds)
A	20
B	45
C	35

- (a) State the source of heat in Rani's experiment. [1]

- (b) Which material A, B or C, is the best conductor of heat? Explain your answer based on the results in the table. [1]

- (c) State another variable that Rani has to keep constant to ensure a fair test. [1]

(Go on to the next page)

SCORE	3
-------	---

Rani lit a tealight candle made of wax as shown in Diagram 1. When the candle was burning, some of the wax was in the liquid state.

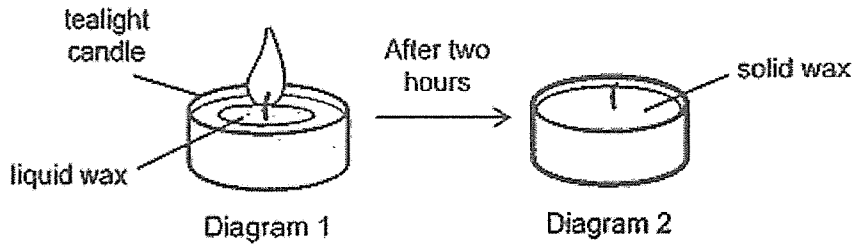

- (d) Two hours after Rani put out the candle, she observed that the liquid wax became solid wax. Explain why. [1]

41. Tula placed a pack of frozen sausages wrapped in plastic from the freezer onto a table. There was a thin layer of ice on the surface of the plastic.

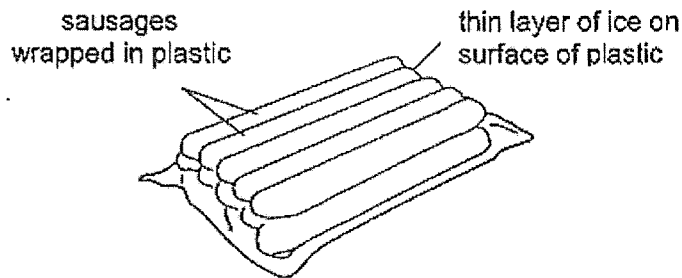

- (a) Name the state of ice. [1]

- (b) After a while, Tula could not see the ice. Instead, there was water around the pack of sausages. Explain why. [2]

(Go on to the next page)

SCORE	4
-------	---

Tula wanted to cook the sausages in boiling water. She prepared two identical set-ups with different volumes of room temperature water as shown.

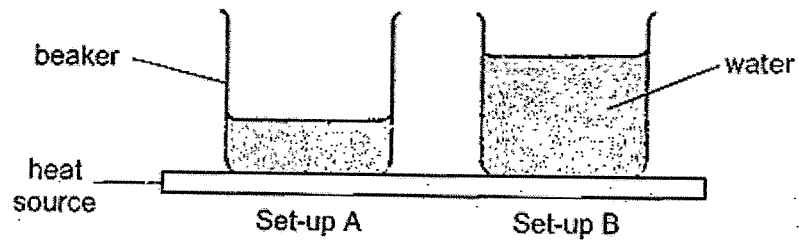

(c) In which set-up, A or B, would the water boil first? Explain your answer. [1]

END OF PAPER

SCORE	1
-------	---

SCHOOL : ACS PRIMARY SCHOOL
 LEVEL : PRIMARY 4
 SUBJECT : SCIENCE
 TERM : 2023 SA2

SECTION A

Q1	Q2	Q3	Q4	Q5	Q6	Q7	Q8	Q9	Q10
3	2	1	4	3	1	2	2	2	4
Q11	Q12	Q13	Q14	Q15	Q16	Q17	Q18	Q19	Q20
2	4	4	2	3	3	1	3	2	1
Q21	Q22	Q23	Q24	Q25	Q26	Q27	Q28		
3	2	4	1	2	2	1	2		

SECTION B

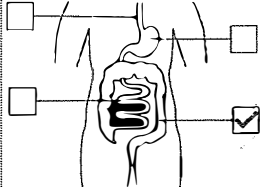
Q29a)	Glass; light; breaks
Q30a)	
Q30b)	Small intestine
Q31a)	Has definite volume
Q31b)	None
Q31c)	Has definite shape & has definite volume
Q32a)	Non-magnetic
Q32b)	Repelling
Q33a)	Matter occupies space and has mass.
Q33b)	Gas, liquid and solid
Q33c)	Pebbles are matter and occupy space. The extra pebbles occupy the space originally taken up by the water and the water would overflow.
Q34a)	Adult → egg → larva → pupa
Q34b)	Oil floating on the surface of the water blocks the breathing tube of the young mosquito, causing them to be unable to breathe. This leads to them dying and will not grow into adult mosquitoes to breed.

Q34c)	The warmer the temperature of the surroundings, the more the mosquito eggs hatched in a day.
Q35a)	i. True ii. False iii. True
Q35b)	The food stored in the seed leaves is being used up by the seedling.
Q35c)	The leaves make food for the plant.
Q36a)	Stroking method
Q36b)	They will attract. End Y of the iron bar becomes the South-pole of the temporary magnet and unlike poles attract so end Y would be attracted to North-pole of magnet Z.
Q36c)	The magnet is the strongest at its poles.
Q37a)	To find out if more coils of wire around the nail will affect the number of steel pins attracted.
Q37b)	Use lighter steel pins.
Q37c)	1. Remove on battery 2. Increase number of coils around iron nail to be equal to set up B
Q37d)	As there was no batteries, the iron nail could not become an electromagnet, so it could not attract any steel pins.
Q38a)	100
Q38b)	Light travels in a straight line.
Q38c)	Type of beaker; type of light sensor; amount of light given off by torch
Q38d)	Add some cooking oil to the water.
Q39a)	Height of shadow decreases.
Q39b)	Move torch closer to the rubber ring.
Q39c)	It is because the material allowed more light to pass through than the rubber ring.
Q40a)	Boiling water.
Q40b)	A. A took the least amount of time for the wax to melt completely as A gains heat the fastest.
Q40c)	Size of rods.
Q40d)	The liquid wax lost heat to the surrounding air and froze to become solid wax.
Q41a)	Solid.
Q41b)	The ice gained heat from the surrounding air and melted into water.
Q41c)	A. The beaker in A has less water, so less heat is needed to boil the water.