



ROSYTH SCHOOL
2022 PRELIMINARY EXAMINATION
MATHEMATICS
PRIMARY 6
PAPER 1

Name: _____

Register No. _____

Class: Pr 6 - _____

Teacher: _____

Date: 23 August 2022

Parent's Signature: _____

Total Time for Booklets A and B : 1 hour

BOOKLET A

Instructions to Pupils:

1. Do not open this booklet until you are told to do so.
2. Follow all instructions carefully.
3. Shade your answers in the Optical Answer Sheet (OAS) provided.
4. You are **not** allowed to use a calculator.
5. Answer all questions.

Section	Maximum Mark	Marks Obtained
Paper 1 (Booklet A)	20	

* This booklet consists of **8** pages (including this cover page).

This paper is not to be reproduced in part or whole without the permission of the Principal.

Questions 1 to 10 carry 1 mark each. Questions 11 to 15 carry 2 marks each.
For each question, four options are given. One of them is the correct answer.
Make your choice (1, 2, 3 or 4). Shade the oval (1, 2, 3 or 4) on the Optical Answer Sheet.

All diagrams in this paper are not drawn to scale unless stated otherwise.

(20 marks)

1. Round off 299.996 to 2 decimal places.

- (1) 299.97
- (2) 299.99
- (3) 300.00
- (4) 300.09

2. Express $8 + 4y - (6 \div 2) - 2y$ in the simplest form.

- (1) $6y + 5$
- (2) $6y + 1$
- (3) $2y + 5$
- (4) $2y + 1$

3. Which of the following is the same as 9070 ml ?

- (1) 9 l 7 ml
- (2) 9 l 70 ml
- (3) 90 l 7 ml
- (4) 90 l 70 ml

Study the bar graphs and answer questions 4 and 5.

Ms Noraini baked some buns to sell. Figure 1 shows the number of buns that she baked. Figure 2 shows the number of buns that were left unsold.

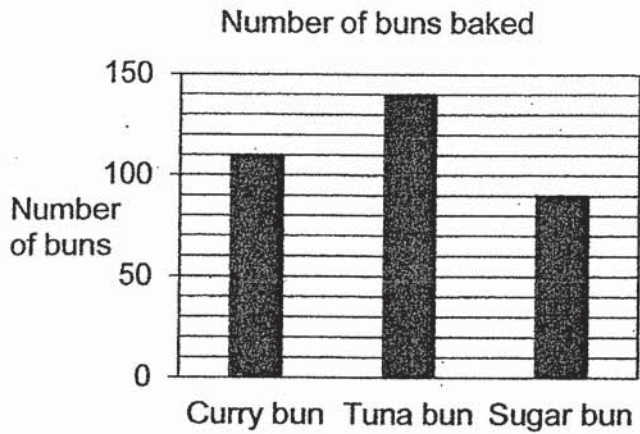

Figure 1

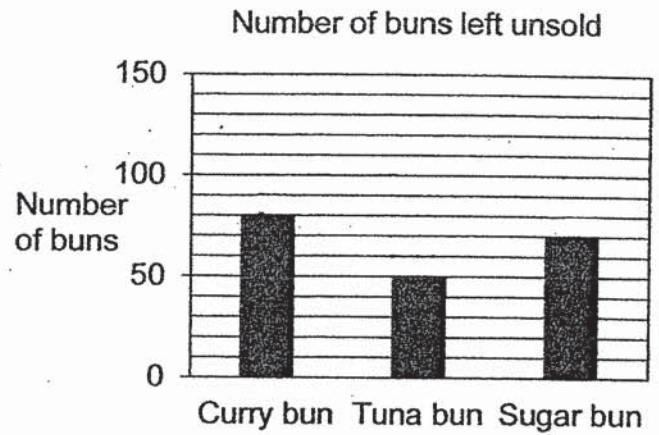

Figure 2

4. How many curry buns and sugar buns did Ms Noraini bake altogether?

- (1) 150
- (2) 200
- (3) 340
- (4) 350

5. How many tuna buns did Ms Noraini sell?

- (1) 20
- (2) 30
- (3) 50
- (4) 90

6. The National Day Parade started at 5.55 p.m. and ended at 8.15 p.m. How long was the National Day Parade? Give your answer in hours and minutes.

- (1) 2 h 10 min
- (2) 2 h 20 min
- (3) 3 h 10 min
- (4) 3 h 20 min

7. Which pair of lines are parallel?

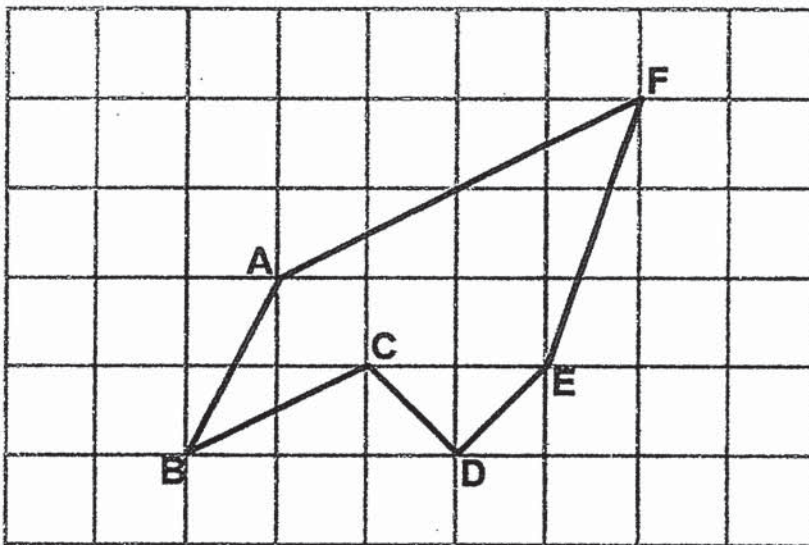

- (1) AB and EF
- (2) CD and DE
- (3) BC and DE
- (4) AF and BC

8. Ali took part in a race. He ran for 3 km and cycled for 9 km. He took a total time of 120 min. What was his average speed for the race?

- (1) 6 km/h
- (2) 7.2 km/h
- (3) 10 km/h
- (4) 24 km/h

9. Which statement about the rhombus is false?

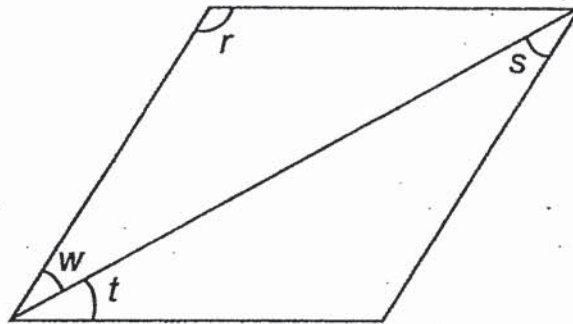

- (1) $\angle w = \angle t$
(2) $\angle t + \angle w = 180^\circ - \angle r$
(3) $\angle r + \angle s + \angle w = 180^\circ$
(4) $\angle s + \angle t + \angle w = 180^\circ$
10. The figure shows an 8-point compass. Vishal was facing south-east (SE) at first. He turned 135° anticlockwise. Which direction does he face now?

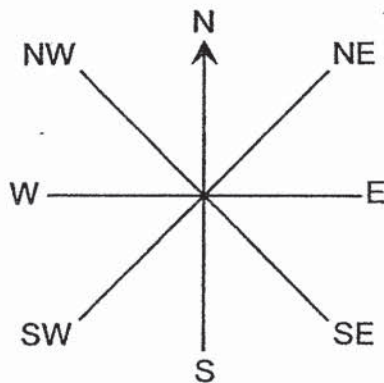

- (1) North (N)
(2) South (S)
(3) East (E)
(4) West (W)

11. The figure shows a pyramid.

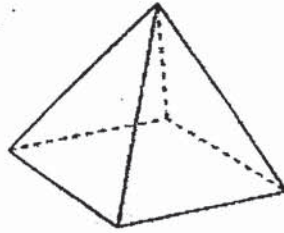

Which of the following are possible nets of the pyramid?

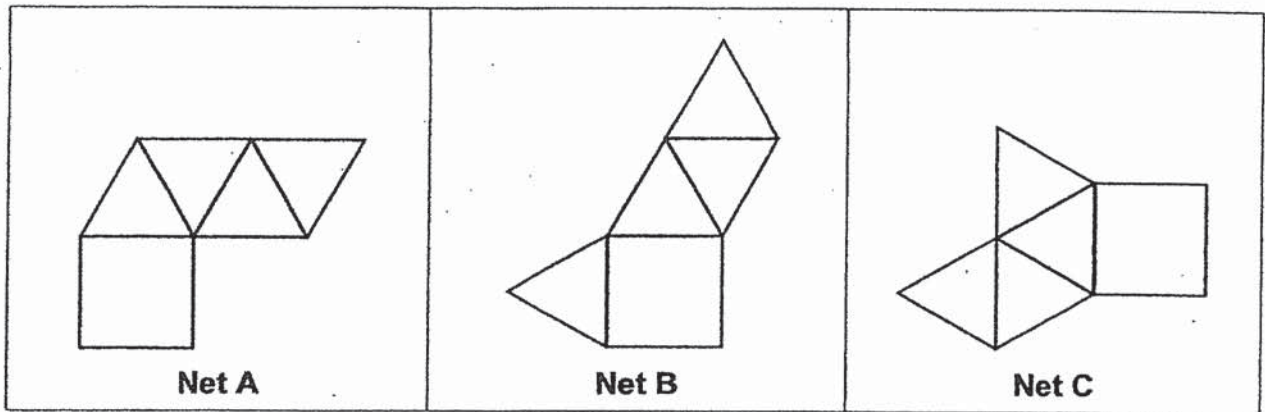

- (1) Net A and Net B
(2) Net A and Net C
(3) Net B and Net C
(4) Net A, Net B and Net C
12. A shop gave a discount of \$0.30 for every \$2 spent. Paul paid \$8.50 for a file after discount. What was the price of the file before the discount?
- (1) \$9.70
(2) \$9.40
(3) \$9.10
(4) \$8.80

13. The figure below is formed by 3 identical shaded circles and a rectangle. The length of the rectangle is 18 cm. Find the total area of the 3 shaded circles. Give your answer in terms of π .

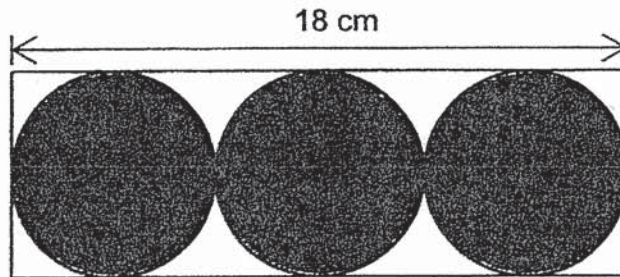

- (1) $9\pi \text{ cm}^2$
(2) $27\pi \text{ cm}^2$
(3) $36\pi \text{ cm}^2$
(4) $108\pi \text{ cm}^2$
14. Sam has a 30 cm paper strip. He cuts it into 4 pieces.
The length of the first piece is 1 cm less than the length of the second piece.
The length of the second piece is 1 cm less than the length of the third piece.
The length of the last piece is 3 cm longer than the length of the first piece.
Find the length of the shortest piece as a fraction of the length of the original strip.

- (1) $\frac{1}{5}$
(2) $\frac{1}{4}$
(3) $\frac{3}{10}$
(4) $\frac{3}{7}$

15. The figure below is made up of 5 identical rectangles. The length of the big rectangle ABCD is 20 cm. Find the area of the shaded triangle.

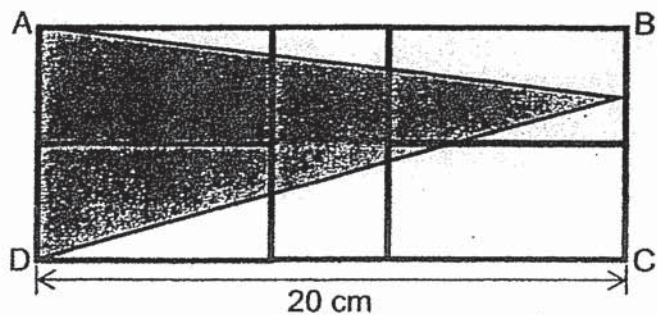

- (1) 5 cm^2
- (2) 80 cm^2
- (3) 100 cm^2
- (4) 160 cm^2



ROSYTH SCHOOL
2022 PRELIMINARY EXAMINATION
MATHEMATICS
PRIMARY 6
PAPER 1

Name: _____ Register No. _____

Class: Pr 6 - _____ Teacher: _____

Date: 23 August 2022 Parent's Signature: _____

Total Time for Booklets A and B : 1 hour

BOOKLET B

Instructions to Pupils:

1. Do not turn over this page until you are told to do so.
2. Follow all instructions carefully.
3. Answer all questions.
4. Use a dark blue or black ballpoint pen to write your answers in the space provided for each question.
5. Do not use correction fluid/tape or highlighters.
6. You are **not** allowed to use a calculator.

Section	Maximum Mark	Marks Obtained
Paper 1 (Booklet B)	25	

* This booklet consists of 9 pages (including this cover page).
This paper is not to be reproduced in part or whole without the permission of the Principal.

Questions 16 to 20 carry 1 mark each. Write your answers in the spaces provided. For questions which require units, give your answers in the units stated.

Do not write in this space

All diagrams in this paper are not drawn to scale unless stated otherwise.
(5 marks)

16. Find the value of $7 \times 2 + (25 - 10) \div 5$

Ans: _____

17. What is the percentage discount for the item shown below?

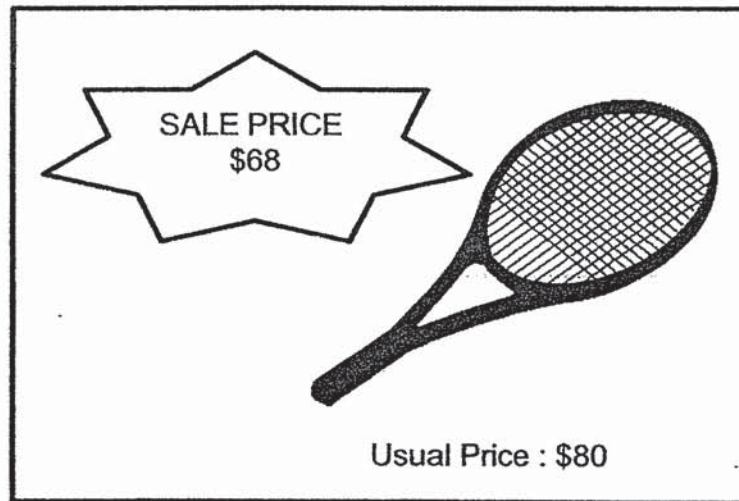

Ans: _____ %

18. Find the average of 5, 11 and 23.

Do not write
in this space

Ans: _____

19. The figure below shows a quadrant with radius 7 cm. What is the perimeter of the quadrant? (Take $\pi = \frac{22}{7}$)

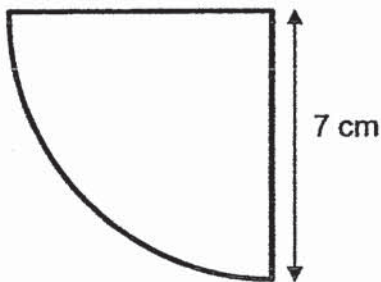

Ans: _____ cm

20. ABC is an isosceles triangle, where $AC = BC$ and $ED \parallel BC$. Find $\angle EDC$.

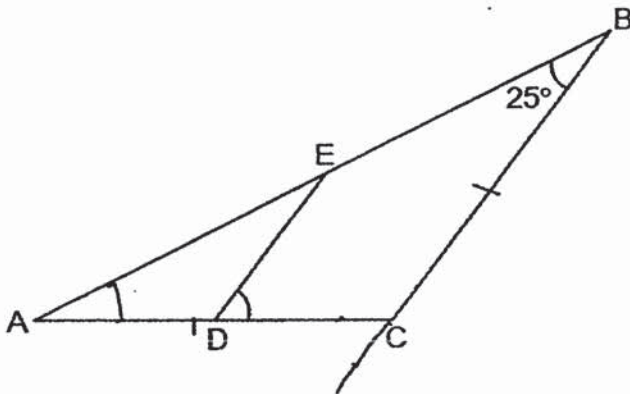

Ans: _____ °

Questions 21 to 30 carry 2 marks each. Show your workings clearly in the space provided for each question and write your answers in the spaces provided. For questions which require units, give your answers in the units stated.

Do not write
in this space

All diagrams in this paper are not drawn to scale unless stated otherwise.
(20 marks)

21. B is a whole number that lies between 40 and 50. It has an odd number of factors. Find the number B.

Ans: _____

22. Find the value of the following when $m = 5$. Leave your answer in the simplest form.

(a) $3m - 3$

Ans: a) _____

(b) $2m - \frac{m}{2}^5$

Ans: b) _____

23. Mary is 16 years old now. Her father is thrice as old as her a year ago. How old is her father now?

Do not write in this space

Ans: _____

24. Tank X contained some water. The base area of the tank is 60 cm^2 . The volume of water in the container is 1020 ml. What is the height of the water level in the tank?

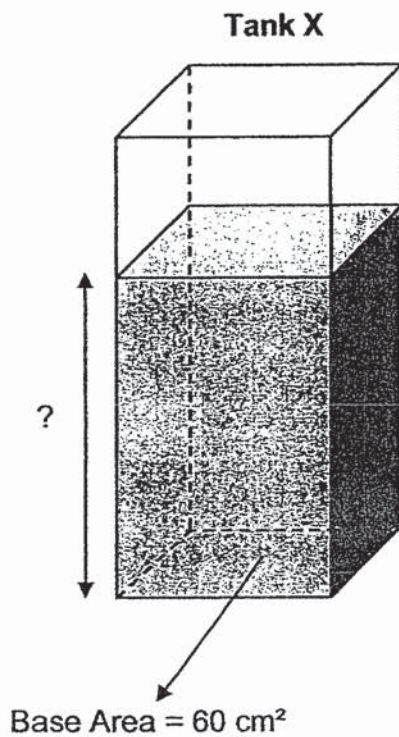

Ans: _____ cm

25. The scores of all the children who participated in a game were recorded. The table shows the number of children with the following scores.

Do not write in this space.

Score	10	15	20	25	30	35	40
Number of children	2	7	8	9	6	5	3

A higher score means a better performance. The prize table for their performance is shown below.

Prize	Condition
Medal	Score at least 30 points.
Sticker	Score above 15 points.

Each of the statement is either true, false or not possible to tell from the information given above. For each statement, put a tick (✓) to indicate your answer.

Statement	True	False	Not possible to tell
40 children participated in the game.			
Medals were given to 20% of the children.			
17 children won only stickers.			

26. The table below shows the rental cost of booking a badminton court.

Day	Cost of rental per hour
Weekdays	\$3
Weekends	\$5

Lily spent a total of \$42 to book the badminton court for 4 hours on Tuesday and a number of hours on Saturday.

How long did she book the badminton court on Saturday?

Ans: _____ h

27. A trapezium ABCD is drawn on a square grid.

Do not write
in this space

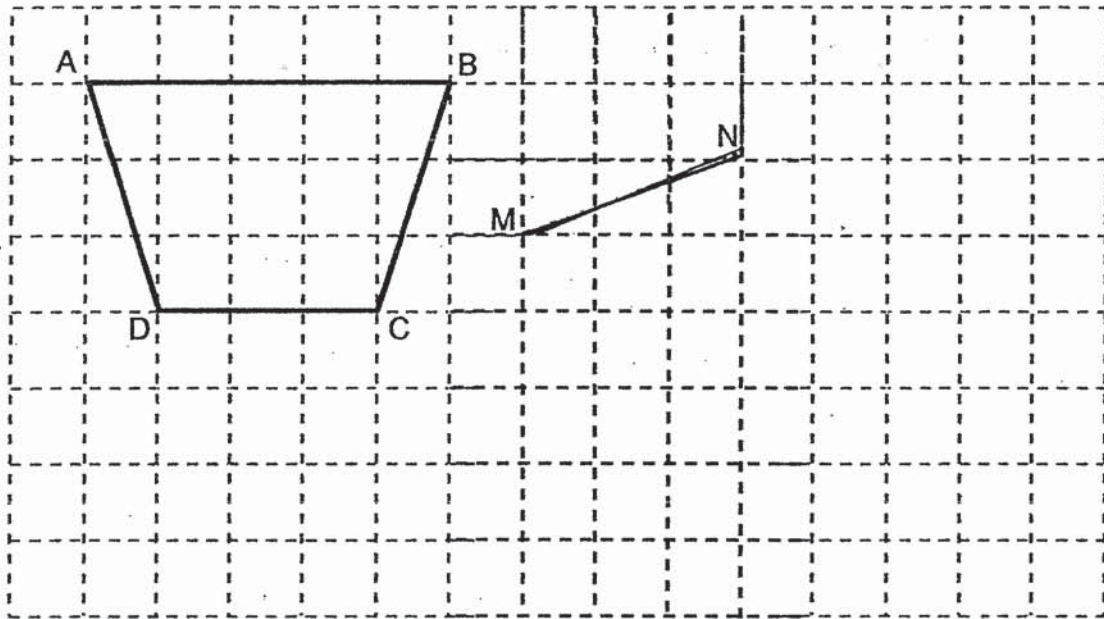

a) Using the line MN, draw a parallelogram MNPQ such that it has the same perimeter as ABCD.

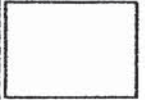

b) Find the ratio of the area of ABCD to the area of MNPQ.

Ans: b) _____

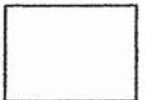

28. In the figure below, PTRS is a trapezium. QTR is a straight line and $PT = PS$. Find $\angle RST$.

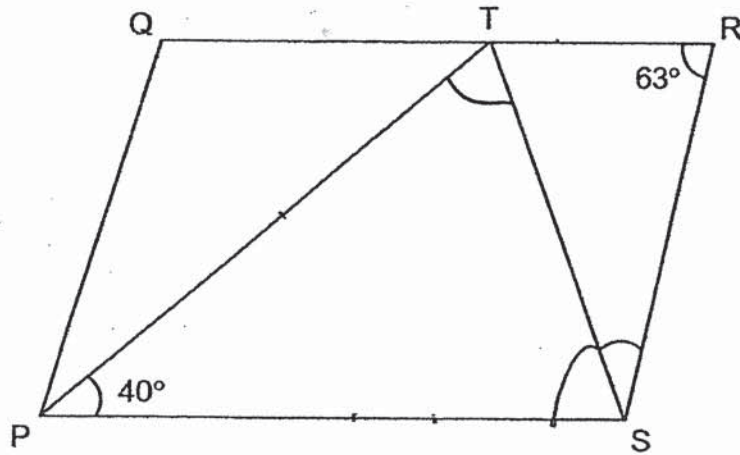

Do not write in this space

Ans: _____ °

29. The table below shows the sum of the numbers in each row.

Row	Sum of numbers
1	1
2	2 + 3 + 4
3	3 + 4 + 5 + 6 + 7
4	4 + 5 + 6 + 7 + 8 + 9 + 10

Find the sum of all the numbers in row 6.

Ans: _____

30. The figure shows two identical equilateral triangles, ABC and CDE. AD, BE and AE are straight lines. Find $\angle x$.

Do not write
in this space

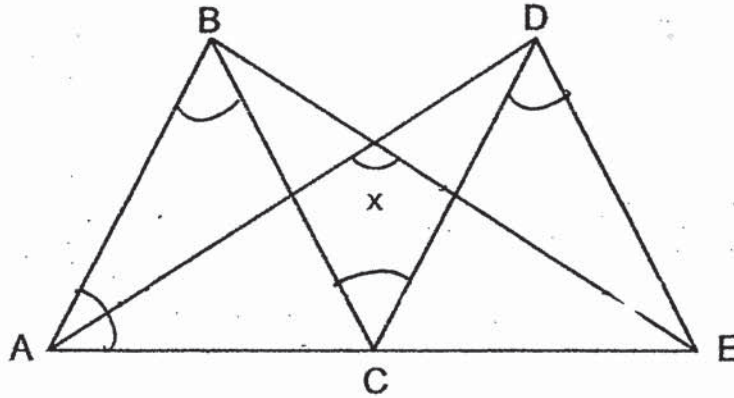

Ans: _____°

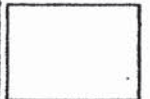

End of paper
Have you checked your work?



ROSYTH SCHOOL
PRELIMINARY EXAMINATION 2022
MATHEMATICS
PRIMARY 6
PAPER 2

Name: _____

Register No. _____

Class: Pr 6 - _____

Teacher: _____

Date: 23 August 2022

Parent's Signature: _____

Time: 1 h 30 min

Instructions to Pupils:

1. Do not turn over this page until you are told to do so.
2. Follow all instructions carefully.
3. Answer all questions.
4. Use a dark blue or black ballpoint pen to write your answers in the space provided for each question.
5. Do not use correction fluid/tape or highlighters.
6. The use of an approved calculator is allowed.

Questions	Maximum Mark	Marks Obtained
Q 1 to 5	10	
Q 6 to 17	45	

Section	Maximum Mark	Marks Obtained
Paper 1	45	
Paper 2	55	
Total	100	

* This booklet consists of 17 pages (including this cover page)
This paper is not to be reproduced in part or whole without the permission of the Principal.

Questions 1 to 5 carry 2 marks each. Show your working clearly in the space provided for each question and write your answers in the spaces provided. For questions which require units, give your answers in the units stated.

Do not write in this space

(10 marks)

All diagrams in this paper are not drawn to scale unless stated otherwise.

1. In the figure below, PQRS is a parallelogram. RSN and QRT are straight lines. Find $\angle SNP$.

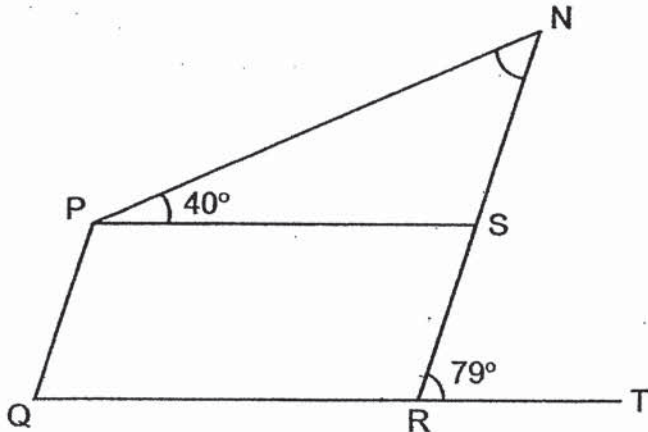

Ans: _____ °

2. Three children shared 34 marbles. Kate has p marbles. Nigel has 11 more marbles than Kate. Rizal has 6 marbles less than Nigel. Find the value of p .

Ans: _____

3. A rectangle is first divided into two equal parts. The left half is divided into 5 equal parts while the right half is divided into 2 equal parts.

Do not write
in this space

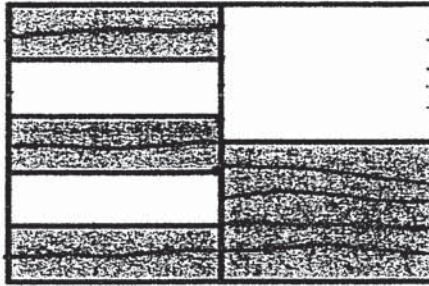

The total area of the shaded parts is 176 cm^2 . What is the area of the rectangle?

Ans: _____ cm^2

4. Mr Tan started cycling from home to work at 450 m/min for 30 minutes. His wife, Mrs Tan, started cycling from home 5 minutes before Mr Tan and reached the same work place 5 minutes after Mr Tan. They travelled the same distance. Find Mrs Tan's cycling speed.

Ans: _____ m/min

5. Students in a hall were lining up in rows. Each row had the same number of students. Jeremy was in one of the rows. There were 7 students to his right and 7 students to his left. There were 21 rows of students in front of him and 21 rows of students behind him. How many students were there in the hall?

Do not write
in this space

Ans: _____

For Questions 6 to 17, show your working clearly in the space provided for each question and write your answers in the spaces provided. The number of marks available is shown in brackets [] at the end of each question or part-question. For questions which require units, give your answers in the units stated. (45 marks)

Do not write
in this space

All diagrams in this paper are not drawn to scale unless stated otherwise.

6. A class of 25 students were each offered a box of donuts to sell during a fun fair. 3 of the students could not sell any of the donuts so they passed their boxes of donuts to the rest of the classmates to sell. As a result, each of the remaining students had to sell 6 more donuts. How many donuts were there in each box at first?

Ans: _____ [3]

7. Container A, B and C had a total of 9894 tokens.

$\frac{1}{5}$ of the tokens in A were transferred into B. $\frac{3}{8}$ of the tokens in A were transferred into C. After that, the 3 containers had an equal number of tokens.

(a) How many tokens were there in each container at the end?

Ans: (a) _____ [1]

Do not write
in this space

(b) What was the number of tokens in Container B at first?

Ans: (b) _____ [2]

8. Ryan and Aqil had 352 stickers altogether. After Ryan lost 25% of his stickers, the ratio of Ryan's stickers to Aqil's stickers was 9 : 4. How many stickers did Aqil have?

Do not write
in this space

Ans: _____ [3]

9. A and B are two rectangular containers. The base area of A is 50 cm^2 while the base area of B is 40 cm^2 . Container A contained some water and the height of the water level in Container A was 43.2 cm as shown below. Container B was empty at first.

Do not write
in this space

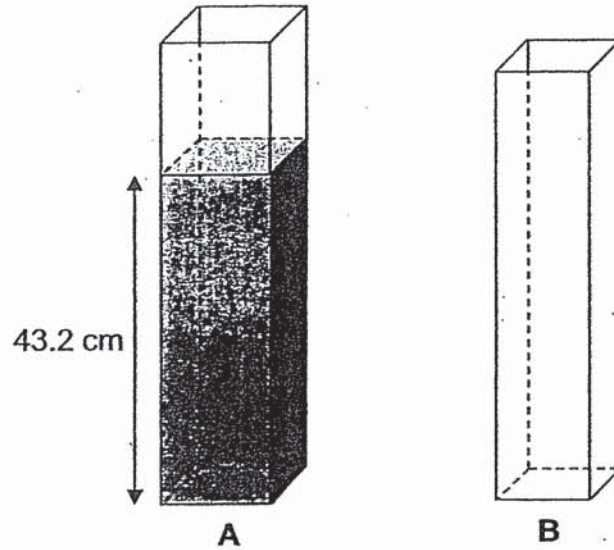

Selina then poured some water from Container A into Container B. After that, the height of the water level in both containers became the same. What was the height of the water level in the end?

Ans: _____ [3]

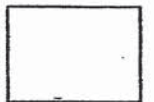

10.

ABCD is a square piece of paper. The paper is folded along the line CX such that point B touches point Y.

Do not write in this space

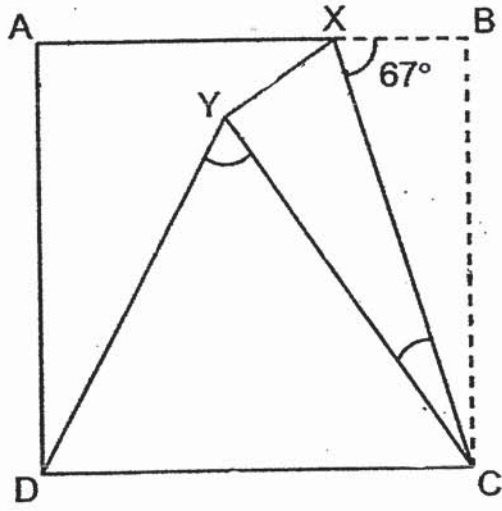

(a) Find $\angle XCY$.

Ans: (a) _____ [1]

(b) Find $\angle CYD$.

Ans: (b) _____ [2]

11.

Imran pasted three rectangular strips of the same size together to form a big rectangle, as shown in Figure 1 below.

Do not write in this space

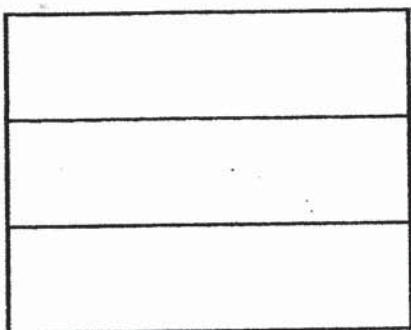

Figure 1

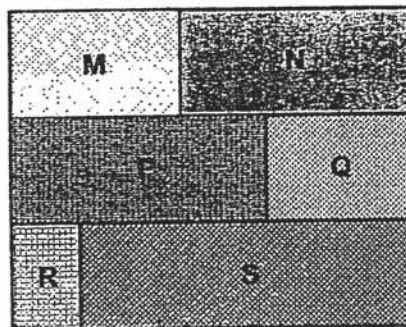
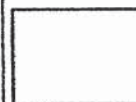

Figure 2

Imran then divided the big rectangle into 6 parts and labelled them M, N, P, Q, R and S, as shown in Figure 2. The ratio of the area of M to the area of N to the area of P is $5 : 7 : 8$. The ratio of the area of Q to the area of R to the area of S is $2 : 1 : 5$. The area of N is bigger than the area of Q by 291 cm^2 .

- (a) What is the ratio of the area of N to the area of S?

Ans: (a) _____ [2]



- (b) Find the area of the big rectangle.

Ans: (b) _____ [2]

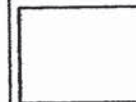

12.

The figure below is formed by 4 identical right-angled isosceles triangles and a square in the centre. The shaded area of the figure is 200 m^2 . Find the perimeter of the square.

Do not write in this space

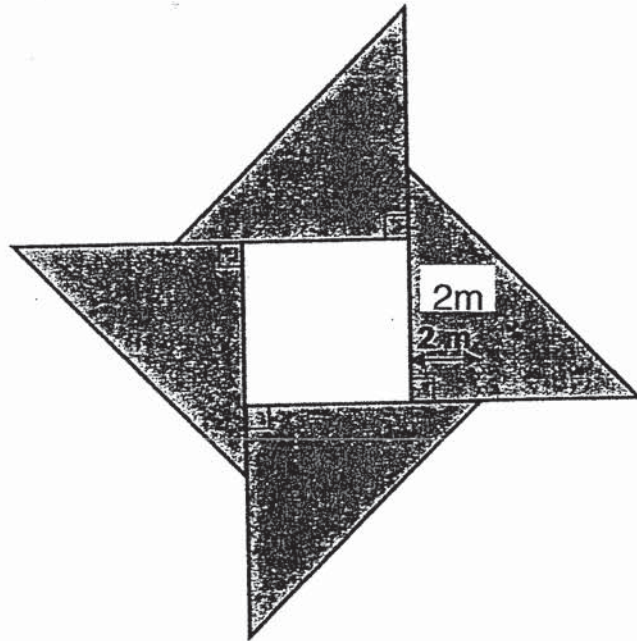

Ans: _____ [4]

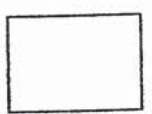

13. The pie chart shows the different flavours of ice-cream that the Primary 6 pupils had chosen.

Do not write in this space.



The number of pupils who have chosen each ice-cream flavour is also represented by the bar graph below. The bars for the number of pupils who chose Chocolate and Mint have not been drawn.

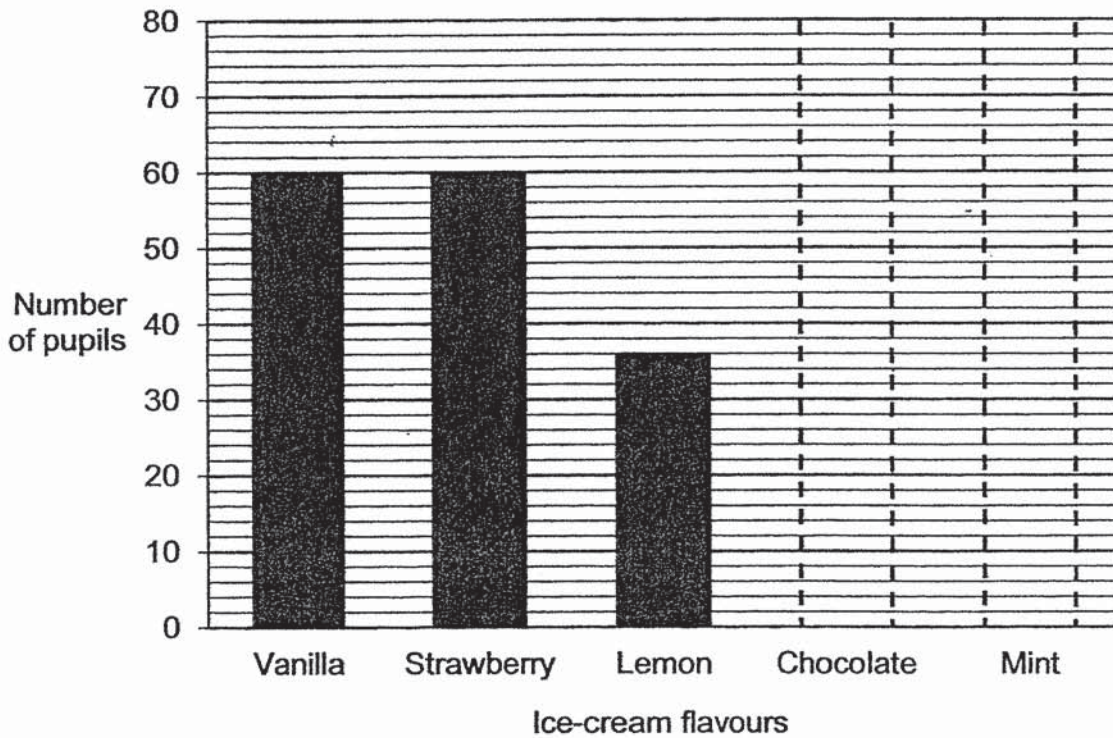

- (a) How many Primary 6 pupils are there?

Ans: (a) _____ [1]

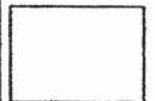

Continue with part (b) on the next page.

(b) The number of pupils who chose Chocolate ice-cream is six times the number of pupils who chose Mint ice-cream. Draw the bars for the number of pupils who have chosen Chocolate ice-cream and Mint ice-cream in the bar graph below.

Do not write in this space

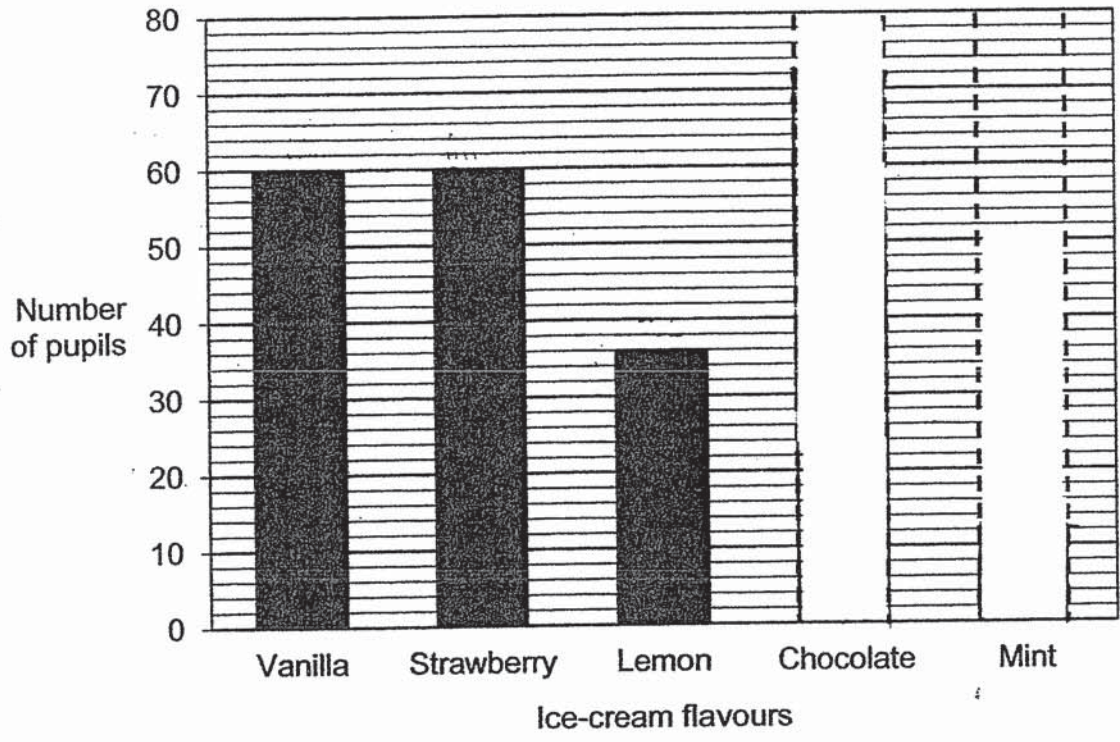

[3]

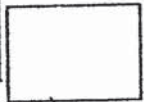

14. A rectangular tank was completely filled with water. Adam turned on Tap D first. Water started flowing out from the tank through Tap D. After 8 minutes, he turned on Tap E, which adds water into the rectangular tank. Both taps were turned off at the same time when the rectangular tank was empty.

Do not write
in this space

The graph below shows the amount of water in the tank for 20 minutes.

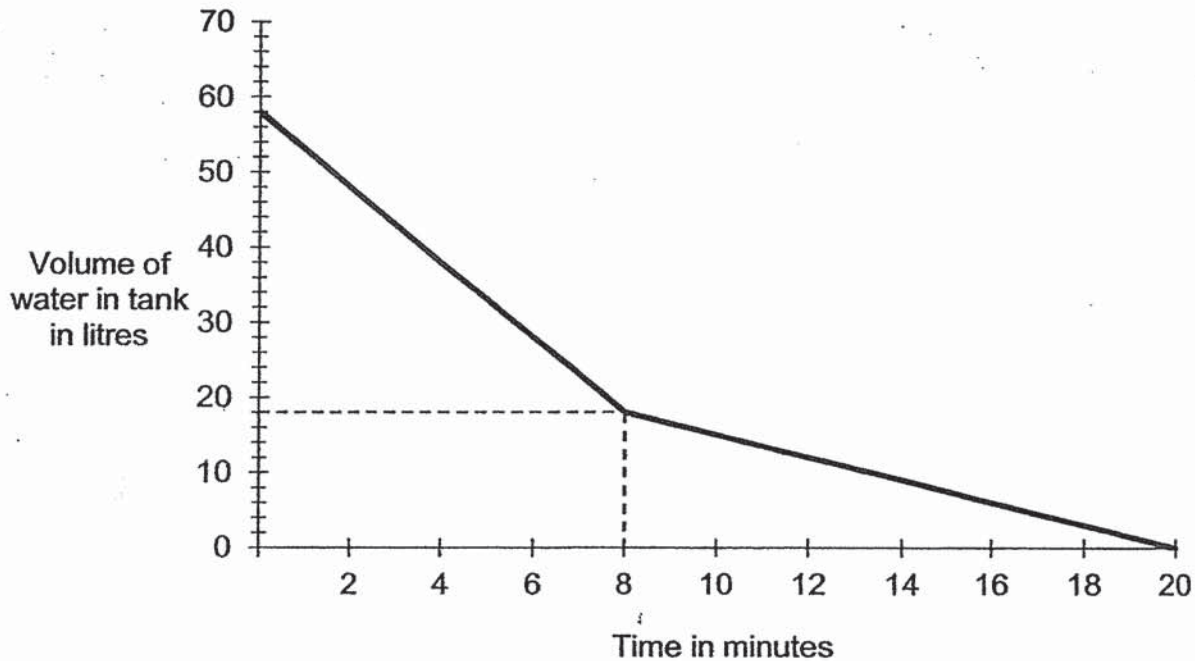

- (a) After Tap D was turned on for 8 minutes, what fraction of the tank was filled with water? Leave your answer in the simplest form.

Ans: (a) _____ [1]

- (b) In one minute, how many litres of water was added by Tap E?

(b) _____ [3]

15. In the figure below, PQST is a rhombus and QRS is a triangle. TSR is a straight line and $TS = SR$.

Do not write in this space

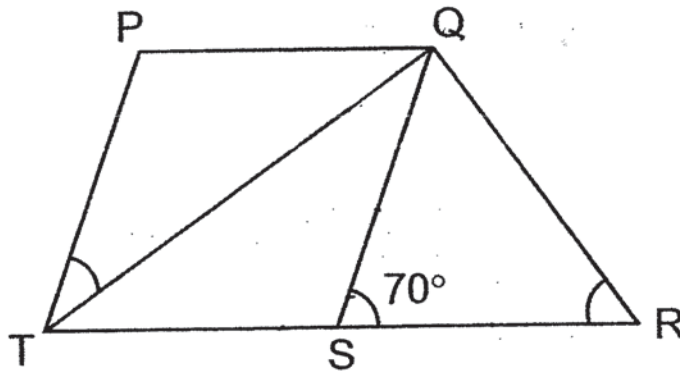

- (a) Find $\angle QRS$.

Ans: (a) _____ [2]

- (b) Find $\angle PTQ$.

Ans: (b) _____ [2]

16. At a shop, pens were only sold in boxes. A box of 6 ballpoint pens cost \$1.80 and a box of 4 gel pens cost \$6.40.

Do not write
in this space

- (a) Sam spent \$10 to buy both types of pens. Find the least total number of ballpoint pens and gel pens bought by Sam.

Ans: (a) _____ [2]

-
- (b) Tom bought 22 more gel pens than ballpoint pens. The total number of pens he bought was more than 40 but fewer than 60. How many pens did Tom buy altogether?

Ans: (b) _____ [3]

17. In January, a kindergarten was given a total sum of \$2400. It spent 80% of the sum of money on books and the rest on stationery. In February, the sum given to the kindergarten was increased. It increased its spending on books by \$240. It spent the remaining 20% of the sum given in February on stationery.

Do not write
in this space

- (a) How much did the kindergarten spend on stationery in January?

Ans: (a) _____ [2]

- (b) What was the percentage increase in the sum of money spent on stationery in February?

Ans: (b) _____ [3]

End of paper
Have you checked your work?

ANSWER KEY

YEAR : 2022
LEVEL : PRIMARY 6
SCHOOL : ROSYTH
SUBJECT : MATHEMATICS
TERM : PRELIMINARY

BOOKLET A (PAPER 1)

Q1	3	Q2	3	Q3	2	Q4	2	Q5	4
Q6	2	Q7	4	Q8	1	Q9	4	Q10	1
Q11	3	Q12	1	Q13	2	Q14	1	Q15	2

BOOKLET B (PAPER 1)

Q16	$7 \times 2 = 14$ $25 - 10 = 15$ $15 \div 5 = 3$ $14 + 3 = 17$ ANS : 17	Q17	$80 \div 100 = 0.8$ $12 \div 0.8 = 15$ ANS : 15%																
Q18	$5 + 11 + 23 = 39$ $39 \div 3 = 13$ ANS : 13	Q19	$(7+7) \times \frac{22}{7} \times \frac{1}{4} = 11$ $11 + 7 + 7 = 25$ ANS : 25cm																
Q20	50°	Q21	49																
Q22	a) $15 - 3 = 12$ b) $10 - \frac{5}{2} = 7\frac{1}{2}$	Q23	Ago $\rightarrow 16 - 1 = 15$ Father $\rightarrow 15 \times 3 + 1 = 46$ ANS : 46																
Q24	$1020 \div 60 = 17$ ANS : 17cm	Q25	<table border="1" style="width: 100%; border-collapse: collapse;"> <thead> <tr> <th style="width: 50%;">Statement</th> <th style="width: 12.5%;">True</th> <th style="width: 12.5%;">False</th> <th style="width: 12.5%;">Not possible to tell</th> </tr> </thead> <tbody> <tr> <td>40 children participated in the game</td> <td style="text-align: center;">√</td> <td></td> <td></td> </tr> <tr> <td>Medals were given 20% of the children.</td> <td></td> <td style="text-align: center;">√</td> <td></td> </tr> <tr> <td>17 children won only stickers.</td> <td style="text-align: center;">√</td> <td></td> <td></td> </tr> </tbody> </table>	Statement	True	False	Not possible to tell	40 children participated in the game	√			Medals were given 20% of the children.		√		17 children won only stickers.	√		
Statement	True	False	Not possible to tell																
40 children participated in the game	√																		
Medals were given 20% of the children.		√																	
17 children won only stickers.	√																		

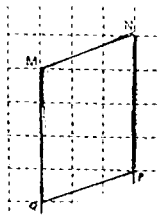
Q26	Tues $\rightarrow 3 \times 4 = 12$ Left $\rightarrow 42 - 12 = 30$ Sat $\rightarrow 30 \div 5 = 6$ ANS : 6h	Q27	a)  b) $ABCD = 12u$ $MNPQ = 12u$ $ABCD : MNPQ$ $12 \div 12 = 1 : 1$
Q28	$\angle PST \rightarrow (180 - 40) \div 2 = 70$ $\angle RST \rightarrow 180 - 70 - 63 = 47$ ANS : 47°	Q29	$15 + 15 + 25 + 11 + 30 + 25 = 121$ ANS : 121
Q30	$\angle BEA \rightarrow 60 \div 2 = 30$ $\angle X \rightarrow 180 - 30 - 30 = 120$ ANS : 120°		

PAPER 2

Q1	$\angle QRS \rightarrow 180 - 79 = 101$ $\angle PSR \rightarrow 180 - 101 = 79$ $\angle NSP \rightarrow 180 - 79 = 101$ $\angle PNS \rightarrow 180 - 101 - 40 = 39$ ANS : 39°	Q2	$3p \rightarrow 34 - 11 - 5 = 18$ $P \rightarrow 18 \div 3 = 6$ ANS : 6
Q3	$\frac{1}{20} \rightarrow 176 \div 11 = 16$ $20u \rightarrow 16 \times 20 = 320$ ANS : 320 cm^2	Q4	Total distance $\rightarrow 450 \times 30 = 13500$ Mrs Tan $\rightarrow 10 \text{ min longer}$ Mrs Tan speed $\rightarrow 13500 \div 40 = 337.5$ ANS : 337.5 m/min
Q5	Total rows $\rightarrow 21 + 21 + 1 = 43$ Students $\rightarrow 43 \times 15 = 645$	Q6	Left $\rightarrow 25 - 3 = 22$ Extra $\rightarrow 22 \times 6 = 132$ 1 box $\rightarrow 132 \div 3 = 44$ ANS : 44
Q7	a) 1 container $\rightarrow 9894 \div 3 = 3298$ ANS : 3298 b) $\frac{1}{40} \rightarrow 3298 \div 17 = 194$ Extra B $\rightarrow 194 \times 8 = 1552$ B $\rightarrow 3298 - 1552 = 1746$ ANS : 1746	Q8	$1u \rightarrow 352 \div 16 = 22$ A $\rightarrow 22 \times 4 = 88$ ANS : 88

Q9	<p>Volume $\rightarrow 43.2 \times 50 = 2160$ 1cm for A $\rightarrow 50\text{cm}^3$ 1cm for B $\rightarrow 40\text{cm}^3$ 1cm for both $\rightarrow 40 + 50 = 90$ Height $\rightarrow 2160 \div 90 = 24$ ANS : 24cm</p>	Q10	<p>a) $\angle XCY \rightarrow 180 - 90 - 67 = 23$ ANS : 23° b) $\angle YCD \rightarrow 90 - 23 - 23 = 44$ $\angle CYD \rightarrow (180 - 44) \div 2 = 68$ ANS : 68°</p>
Q11	<p>a) 7 : 10 b) $1u \rightarrow 291 \div 3 = 97$ Total area $\rightarrow 97 \times 36 = 3492$ ANS: 3492cm^2</p>	Q12	<p>1 big square $\rightarrow 100\text{cm}^2$ Length of $\Delta \rightarrow \sqrt{100}$ Perimeter of the square $\rightarrow (10 - 2) \times 4 = 32$ ANS : 32cm</p>
Q13	<p>a) Pupils $\rightarrow 60 \times 4 = 240$ b) $V+S+L \rightarrow 60+60+36=156$ $7u \rightarrow 240-156=84$ $1u \rightarrow 84 \div 7 = 12$ Choc $\rightarrow 12 \times 6 = 72$</p>	Q14	<p>a) $\frac{18}{58} = \frac{9}{29}$ b) D drain after $\rightarrow 18 \div 12 = 1.5\ell$ per min $E \rightarrow 5 - 1.5 = 3.5$ ANS : 3.5ℓ</p>
Q15	<p>a) $\angle QRS \rightarrow (180-70) \div 2 = 55^\circ$ b) $\angle PTQ \rightarrow 70 \div 2 = 35^\circ$</p>	Q16	<p>a) 4 gels after $\rightarrow 10 - 6.4 = 3.6$ Pacts $\rightarrow 3.6 \div 1.8 = 2$ Pens $\rightarrow 6+6+4=16$ ANS : 16 b) 10 box of gel pens $\rightarrow 4 \times 10 = 40$ No of ball pens $\rightarrow 40 - 22 = 18$ Total pens $\rightarrow 40 + 18 = 58$ ANS : 58</p>
Q17	<p>a) 10% $\rightarrow 2400 \div 10 = 240$ Stationery $\rightarrow 240 \times 2 = 480$ ANS : \$480 b) Feb \rightarrow Books : 80% $1920 + 240 = 2160$ Stationery : 20% $\frac{2160}{4} = 540$ % increase $\rightarrow \frac{60}{480} \times 100$ $= 12.5$ ANS : 12.5%</p>		

3
END

