

PAYA LEBAR METHODIST GIRLS' SCHOOL (PRIMARY)

PRELIMINARY EXAMINATION, 2022

PRIMARY SIX

**MATHEMATICS
PAPER 1
(BOOKLET A)**

NAME : _____ ()

CLASS : P 6 _____

DATE : 19 August 2022

Total Time for Booklets A and B: 1 hour

INSTRUCTIONS TO CANDIDATES

1. Do not turn over this page until you are told to do so.
2. Follow all the instructions carefully.
3. Answer all questions.
4. Shade your answers in the Optical Answer Sheet (OAS) provided.
5. You are **not** allowed to use a calculator.

	Marks Obtained	/	Maximum Marks
PAPER 1(Booklet A)		/	20
PAPER 1(Booklet B)		/	25
PAPER 2		/	55
TOTAL		/	100

Parent's Signature: _____

Questions 1 to 10 carry 1 mark each. Questions 11 to 15 carry 2 marks each.
For each question, four options are given. One of them is the correct answer.
Make your choice (1, 2, 3 or 4). Shade the correct oval (1, 2, 3 or 4) on the Optical Answer Sheet. (20 marks)

1. Which of the following is one hundred and four thousand and two in numerals?

- (1) 1 042 000
- (2) 104 002
- (3) 14 020
- (4) 10 042

2. Which of the following is the same as 3050.cm?

- (1) 0.305 m
- (2) 30.05 m
- (3) 30.5 m
- (4) 3.05 m

3. Part of a scale is shown below. What is the value of the reading at X?

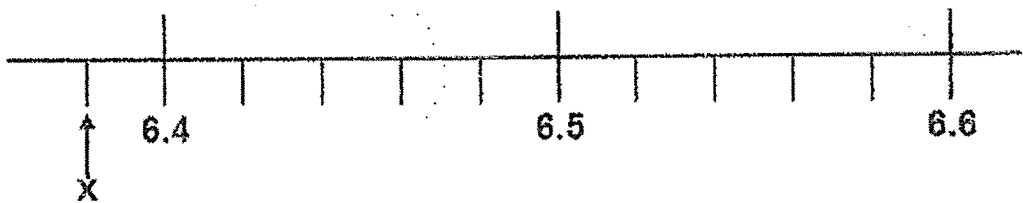

- (1) 6.39
- (2) 6.38
- (3) 6.34
- (4) 6.30

4. The diagram below shows a car.
Which of the following could be the length of the car?

- (1) 4.5 m
- (2) 4.5 km
- (3) 45 cm
- (4) 45 m

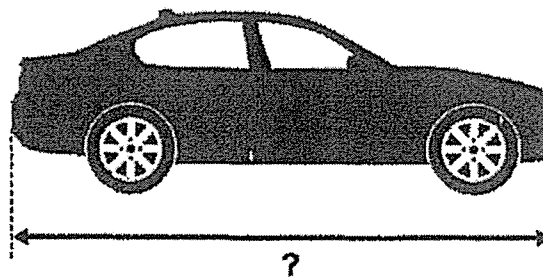

5. The bar graph below shows the number of medals won by 3 classes during a Sports Meet.

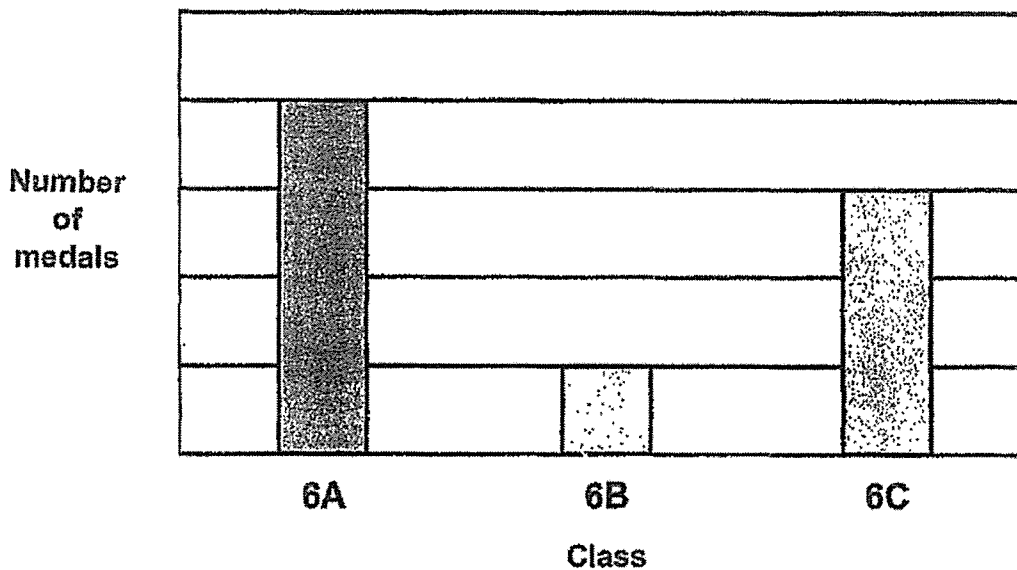

What percentage of the medals was won by Class 6B?

- (1) 12.5 %
- (2) 25 %
- (3) 35 %
- (4) 37.5 %

6. In the figure, ABCD is a square. DB and DE are straight lines.
 $\angle DEC = 75^\circ$. Find $\angle BDE$.

- (1) 15°
- (2) 20°
- (3) 30°
- (4) 45°

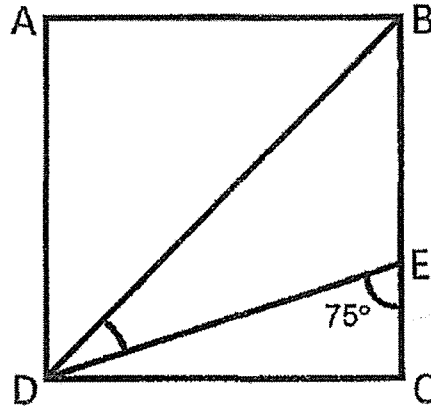

7. The shaded figure is a quarter circle of radius 7 cm.
What is the perimeter of the shaded figure? Take $\pi = \frac{22}{7}$

- (1) 18 cm
- (2) 25 cm
- (3) 36 cm
- (4) 58 cm

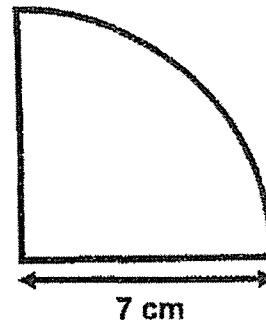

8. During a sale, a chair was sold at \$210. This was 30% less than the usual price of the chair. What was the usual price of the chair?
- (1) \$63
 - (2) \$147
 - (3) \$300
 - (4) \$700

9. Which of the following is not the net of a cube?

(1)

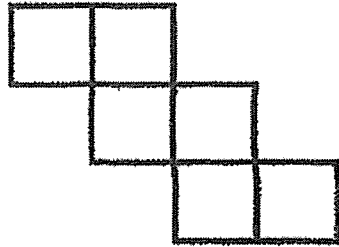

(2)

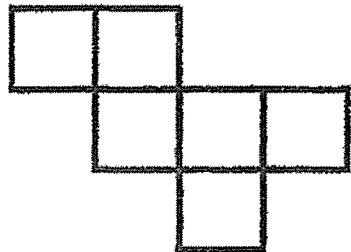

(3)

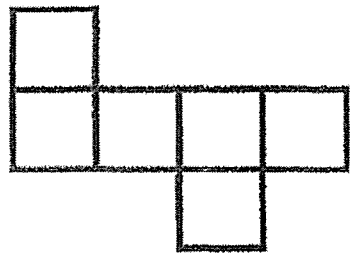

(4)

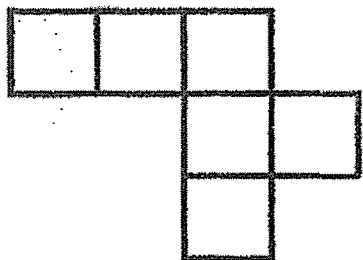

10. Some pupils were asked to choose one brand of pen from Brands A, B, C or D. The pie chart shows their choices. Half of the pupils chose Brand A.

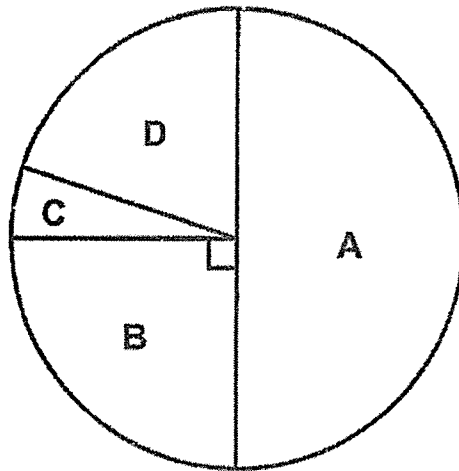

Which bar graph best represents the information in the pie chart above?

(1)

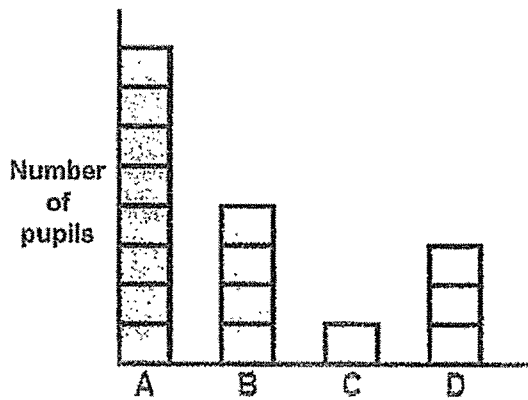

(2)

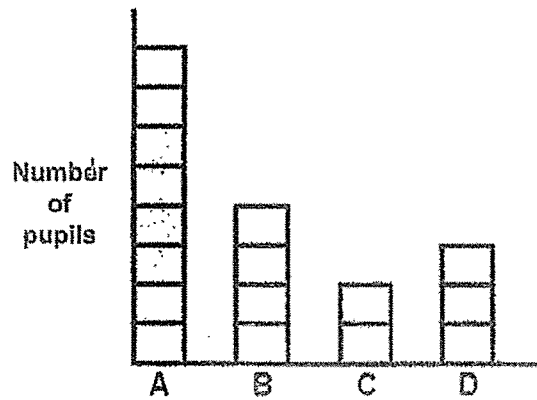

(3)

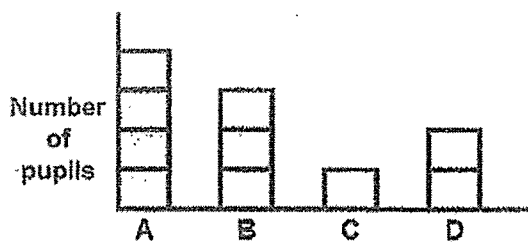

(4)

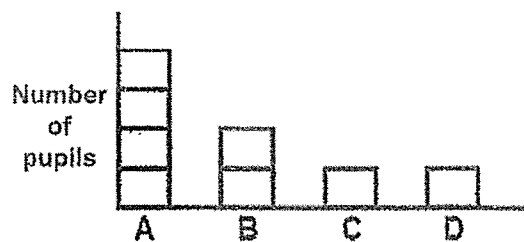

11. Mina has \$ p . She has half as much money as Siti. Linda has \$7 less than Siti. How much money does Linda have?

(1) $\$(2p - 7)$

(2) $\$(2p + 7)$

(3) $\$(\frac{p}{2} - 7)$

(4) $\$(\frac{p}{2} + 7)$

12. Participants of a quiz must obtain at least a certain score to win a prize. There were 90 participants and the table below shows the number of participants with the following scores.

Score	Number of Participants
20	4
22	10
24	13
25	27
28	9
29	20
30	7

$\frac{3}{10}$

30% of the participants won prizes. From the table, what was the highest score of a participant who did not win a prize?

(1) 29

(2) 28

(3) 25

(4) 24

13. Figure 1 shows a triangle with a perimeter of 25 cm. The shortest side of the triangle is 5 cm. Figure 2 is formed using 5 such triangles.

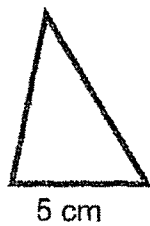

Figure 1

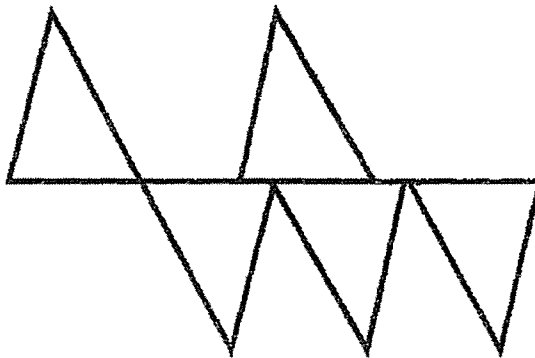

Figure 2

Find the perimeter of Figure 2.

- (1) 125 cm
 - (2) 120 cm
 - (3) 115 cm
 - (4) 110 cm
14. John had $5x$ packets of game cards. Each packet contained 7 game cards. After giving away 1 packet of game cards, how many game cards had he left?
- (1) $28x$
 - (2) $5x - 1$
 - (3) $35x - 1$
 - (4) $35x - 7$

15. A table with 4 columns is filled with numbers in a certain pattern. The first five rows of the table are shown below.

	Column A	Column B	Column C	Column D
Row 1	1		2	
Row 2		4		3
Row 3	5		6	
Row 4		8		7
Row 5	9		10	
⋮	⋮	⋮	⋮	⋮

In which column will the number 923 appear?

- (1) Column A
- (2) Column B
- (3) Column C
- (4) Column D

End of Booklet A

PAYA LEBAR METHODIST GIRLS' SCHOOL (PRIMARY)

PRELIMINARY EXAMINATION, 2022

PRIMARY SIX

**MATHEMATICS
PAPER 1
(BOOKLET B)**

NAME : _____ ()

CLASS : P 6 | _____

DATE : 19 August 2022

Total Time for Booklets A and B: 1 hour

INSTRUCTIONS TO CANDIDATES

1. Do not turn over this page until you are told to do so.
2. Follow all the instructions carefully.
3. Answer all questions.
4. You are not allowed to use a calculator.

	Marks Obtained	Maximum Marks
Booklet B	/	25

Questions 16 to 20 carry 1 mark each. Write your answers in the spaces provided.
For questions which require units, give your answers in the units stated. (5 marks)

Do not write
in this space

16. Find the value of $(24 - 9 \div 3) \times 5$

Ans: _____

17. Find the value of $\frac{2}{3} \div 8$

Give your answer as a fraction in the simplest form.

Ans: _____

18. Shawn left his home at 5.50 a.m. and travelled for $1\frac{1}{4}$ h to reach his school.
What time did Shawn reach his school?

Ans: _____ a.m.

19. Find $\angle p$ in the figure below.

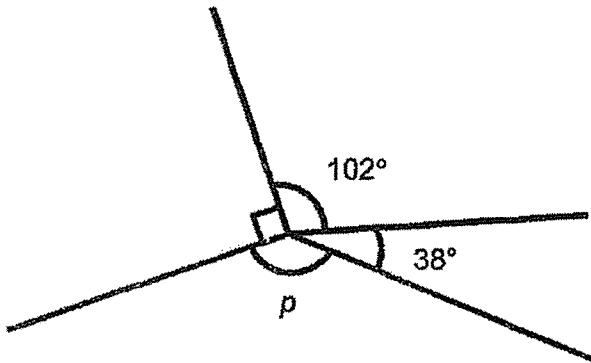

Do not write
in this space

Ans: _____°

20. In a school hall, the number of girls was 40% less than the number of boys. There were 408 children altogether. How many girls were there in the hall?

Ans: _____

Questions 21 to 30 carry 2 marks each. Show your working clearly and write your answers in the spaces provided. For questions which require units, give your answers in the units stated. (20 marks)

Do not write in this space

21. Find the value of

(a) $\frac{7}{8} \frac{2}{3}$

Ans: (a) _____

(b) $5m - 9 - m + 2m + 12$

Ans: (b) _____

22. In the diagram below, the cubical tank is half filled with water. What is the volume of the water in the tank? Give your answer in litres.

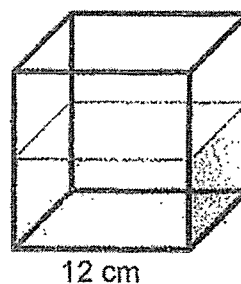

Ans: _____ ℓ

23. The square grid shows the positions of points A, B, C and D.

Do not write
in this space

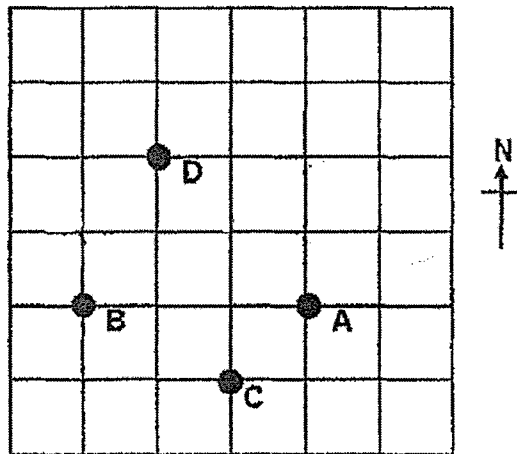

(a) Ravi walked directly from point A to point B in a straight line.
In which direction did Ravi walk?

Ans: (a) _____

(b) Jane was standing at a location south-east of point D and north of point C.
Mark Jane's position on the square grid with an X.

24. The figure below is made up of a semicircle and a quarter circle, both of radius 10 cm. Find the area of the shaded part. Take $\pi = 3.14$.

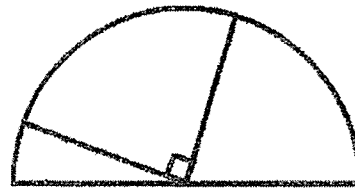

Ans: _____ cm²

25. 8 identical cubes are stacked to form the following solid.

Do not write
in this space

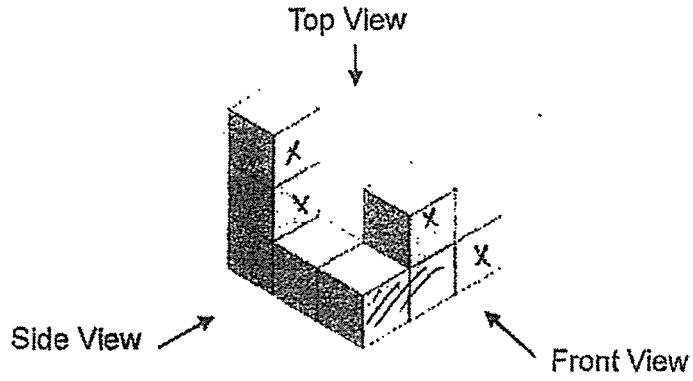

(a) Draw the top view of the solid in the square grid below.

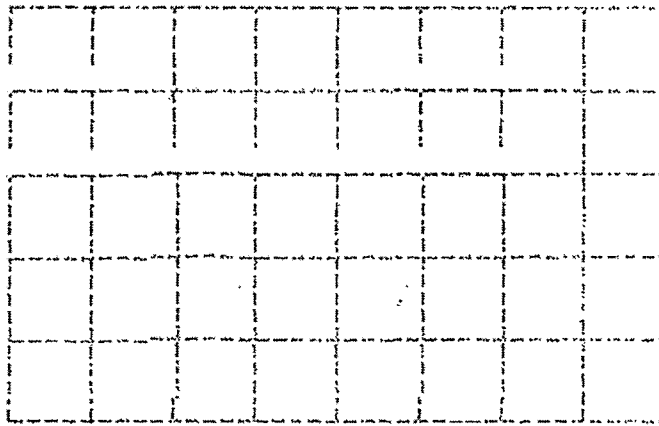

(b) Find the **least** number of cubes that can be removed from the above solid such that the new solid has the following front view:

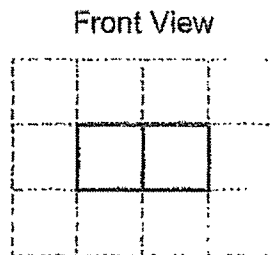

Ans: (b) _____



Do not write
in this space

26. Norman's daily allowances for a particular week are shown in the table below.

Day	Mon	Tue	Wed	Thur	Fri	Sat	Sun
Amount (\$)	8	10	8	5	6	5	0

Find his average daily allowance for the week.

Ans: \$ _____

27. ABCD is a trapezium. AB is parallel to DC. AB = BC.

$\angle ABC = 100^\circ$ and $\angle ADC = 62^\circ$.

Find $\angle CAD$.

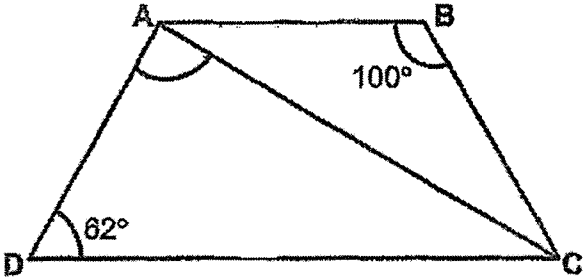

Ans: _____ °

28. A tank, which was completely filled with water at first, started leaking. Water flowed out of the tank until it was completely emptied.

Do not write
in this space

The line graph shows the volume of water in the tank during the first 7 minutes.

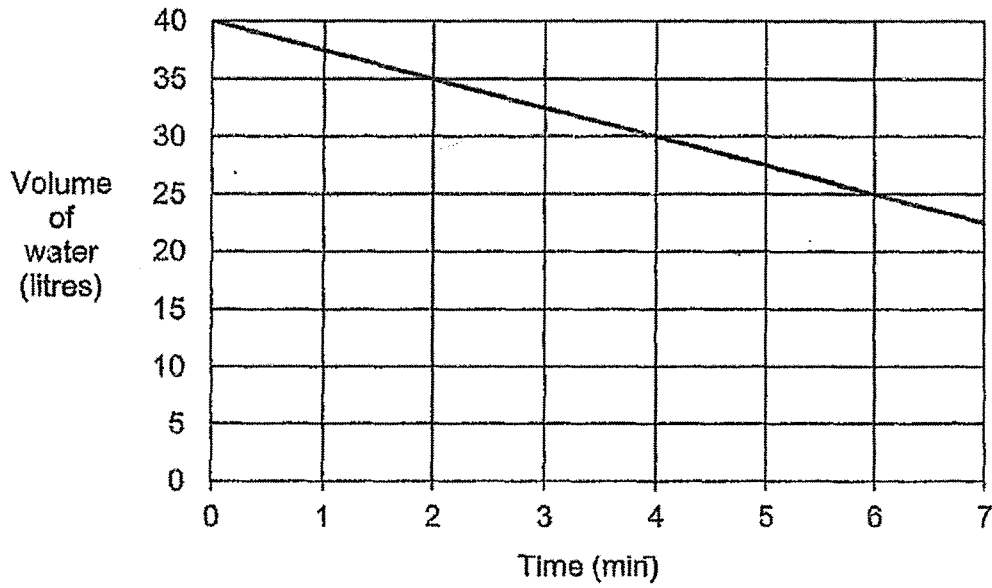

At this rate, how long did it take to empty the tank?

Ans: _____ min

Do not write
in this space

29. A trapezium **G** is drawn by joining dots on the square grid below with four straight lines. In the same way,

(a) draw a rectangle with the same area as **G**. Label the rectangle **R**.

(b) draw a parallelogram with the same perimeter as **G**.
Label the parallelogram **P**.

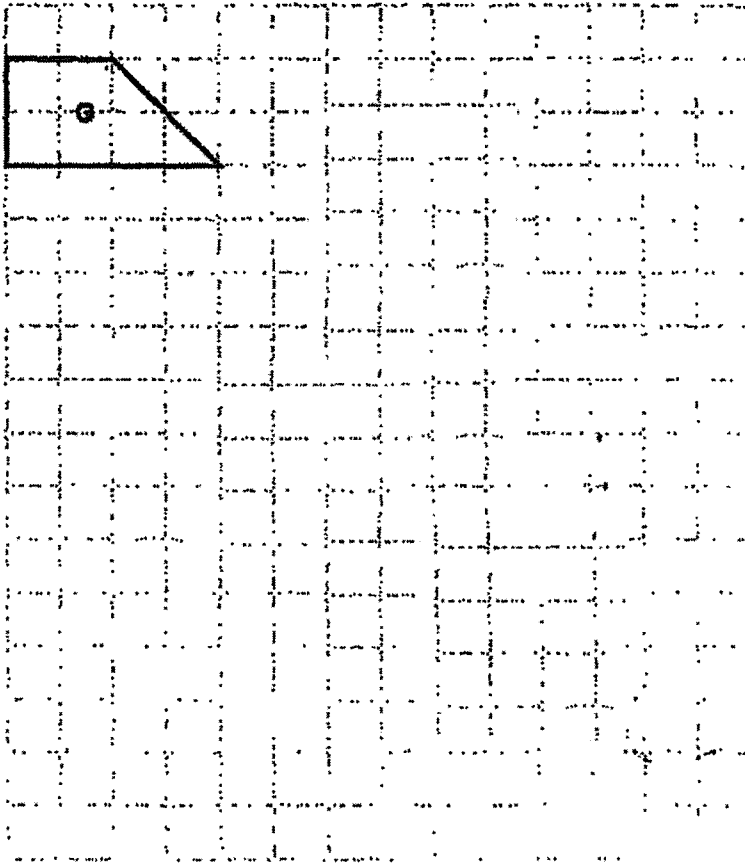

Do not write
in this space

30. A box contained red, blue, yellow and green beads. The table below provides information about the number of each type of beads. The number of red beads was covered by an ink blot.

Colour	Number of Beads
Red	
Blue	10 %
Yellow	$\frac{1}{5}$
Green	More than 30%

Each statement below is either true, false or not possible to tell from the information given above. For each statement, put a tick (✓) to indicate your answer.

Statement	True	False	Not possible to tell
There are 105 beads in the box altogether.			
40% of the beads are red.			
There are more red beads than green beads.			

End of Booklet B

Questions 1 to 5 carry 2 marks each. Show your working clearly and write your answers in the spaces provided. For questions which require units, give your answers in the units stated. (10 marks)

Do not write in this space

1. Find the area of Triangle ABC.

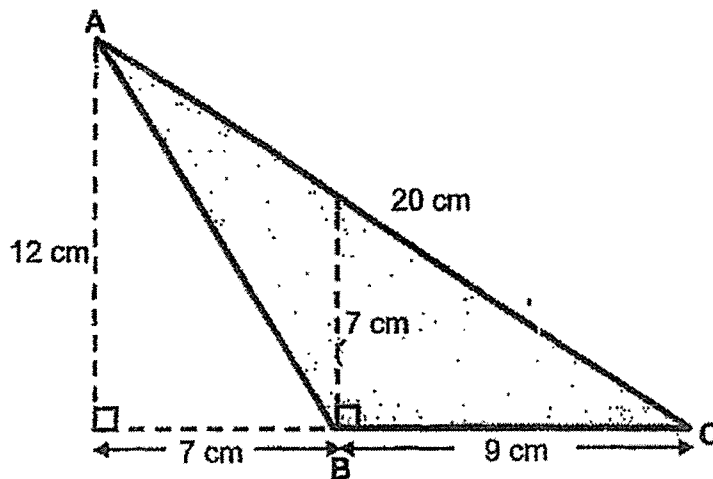

Ans: _____ cm²

2. The total cost of a handphone and a laptop is \$1185. The handphone costs $\frac{2}{3}$ as much as the laptop. What is the cost of the handphone?

Ans: \$ _____

3. AEB is an equilateral triangle and FBC is a straight line. Find $\angle BDC$.

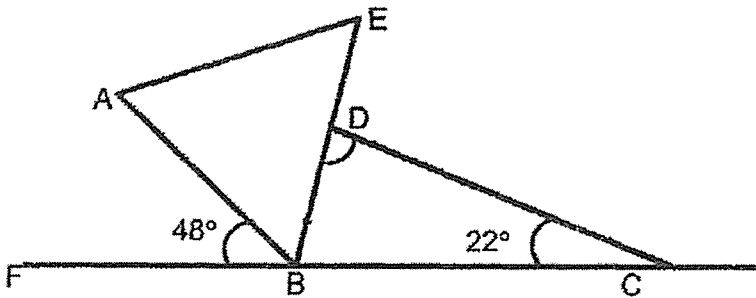

Ans: _____ °

Do not write
in this space

4. The sum of three different 3-digit numbers is 375. The smallest number is 120. What is the biggest possible difference between the other two numbers?

Ans: _____

5. The table below shows how Aaron, Bernice and Charlotte shared the cost of a present for their mother. They paid a total of \$170 for the present.

Child	Amount (\$)
Aaron	$4m$
Bernice	$2m + 3$
Charlotte	$m - 1$

Find the value of m .

Ans: _____

For questions 6 to 17, show your working clearly and write your answers in the spaces provided. The number of marks available is shown in brackets [] at the end of each question or part-question. (45 marks)

Do not write in this space

6. Muthu cycled from point A to point B at 375 m/min. Then, he used the same amount of time to cycle from point B to point C. What was his average speed for the entire journey? Express your answer in m/min.

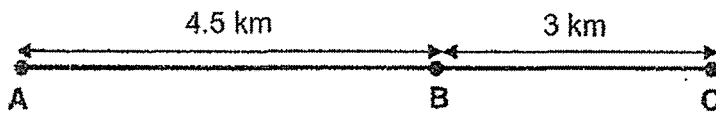

Ans: 375 m/min [3]

7. The participants of a run were divided equally into Group A and Group B. The ratio of the number of boys to the number of girls was 1 : 2 in Group A and 4 : 3 in Group B. A total of 345 girls took part in the run. How many more boys were there in Group B than in Group A?

Do not write
in this space

Ans: _____ [3]



8. Amy packed some 3-cm cubes into a box shown below. She wanted to fill the remaining space with as many 2-cm cubes as possible and still be able to close the cover of the box. How many 2-cm cubes would she need?

Do not write
in this space

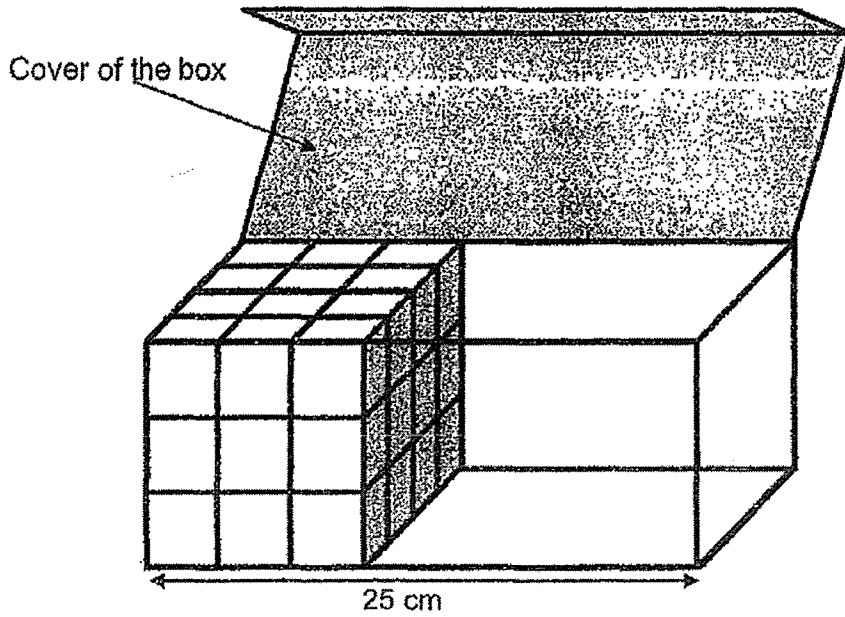

Ans: _____ [3]

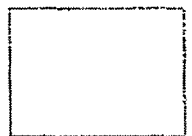

9. The actual average income of a group of adults was \$3150. When Ms Tan recorded the income of these adults, she wrongly keyed in one adult's income as \$2400 when it should have been \$4200. As a result, Ms Tan calculated the average income as \$3100. How many adults were there in the group?

Do not write
in this space

Ans: _____ [3]

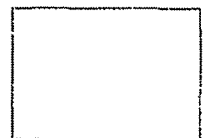

10. At first, Mr Ahmad had a total of 600 bowls and plates in his shop.

He sold $\frac{3}{5}$ of the bowls and 124 plates. After that, Mr Ahmad had thrice as many bowls as plates in his shop.

(a) What was the ratio of the number of bowls sold to the number of bowls left in Mr Ahmad's shop? Express your answer in its simplest form.

Ans: (a) _____ [1]

(b) How many plates and bowls did he sell altogether?

Ans: (b) _____ [3]

Do not write
in this space



11. The figure is made up of a square and a quarter circle.
The ratio of the length of AB to the length of AC is 2 : 3.

Do not write
in this space

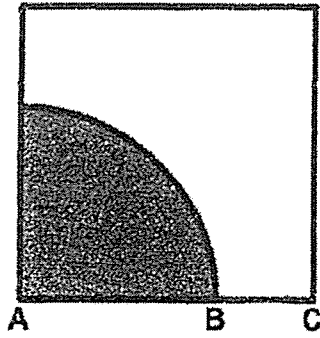

- (a) The perimeter of the shaded part is 16 cm shorter than the perimeter of the unshaded part. What is the length of AC?

Ans: (a) _____ [1]

- (b) What percentage of the square is shaded? Round your answer to 2 decimal places. Take $\pi = 3.14$

Ans: (b) _____ [3]



12. ABCD is a parallelogram and DFCG is a rhombus. EFC is a straight line.

Do not write
in this space

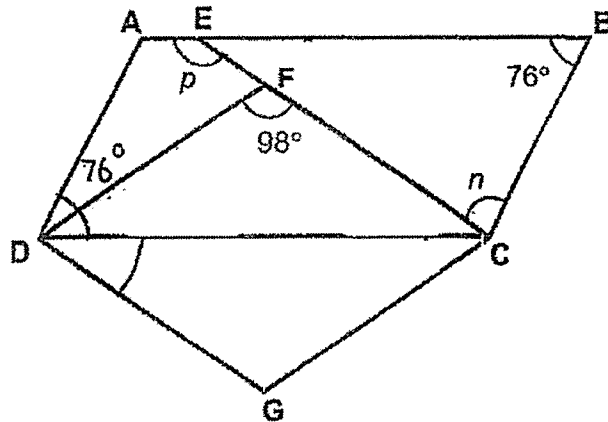

(a) Find $\angle n$.

Ans: (a) _____ [2]

(b) Find $\angle p$.

Ans: (b) _____ [1]

(c) Circle the word that describes triangle BCE.

Triangle BCE (is / is not) an isosceles triangle. [1]



13. Sue had $\frac{2}{3}$ as many stickers as Peggy. Esther had 12 more stickers than Sue. After Peggy gave 40 stickers to Sue and some stickers to Esther, all three girls had the same number of stickers.

Do not write
in this space

(a) How many stickers did Peggy give to Esther?

Ans: (a) _____ [1]

(b) How many stickers did the three girls have altogether?

Ans: (b) _____ [3]



14. Mr Lim and Mr Tan each had 200 identical pots to sell. Both started selling the pots on the same day. The line graphs show the total number of pots sold by them by the end of each day.

Do not write in this space

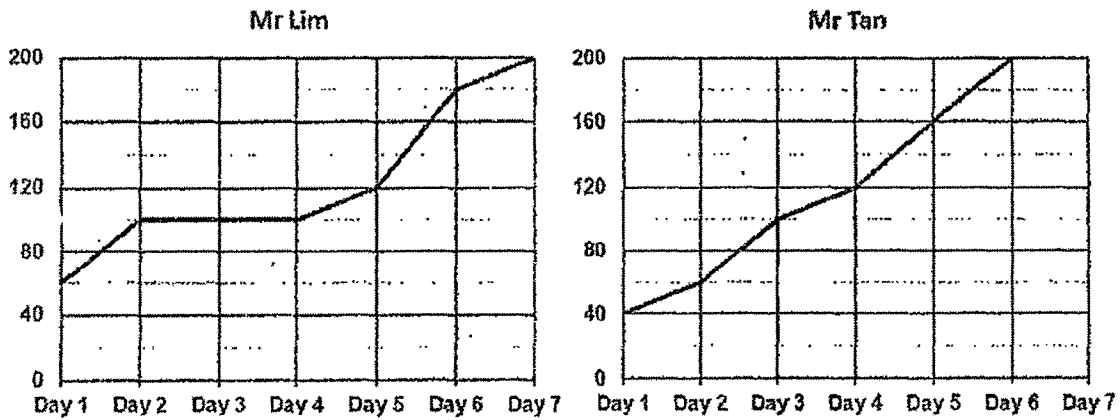

(a) Who took fewer days to sell half of his pots?

Ans: (a) _____ [1]

(b) How many pots did Mr Lim sell on Day 6?

Ans: (b) _____ [1]

(c) The original price of each pot was \$70. On the day when Mr Tan had sold 80% of his pots, Mr Lim decided to offer a 15% discount for his remaining pots. How much did Mr Lim collect from the sale of these remaining pots?

Ans: (c) _____ [2]



15. The figure below shows the net of a solid with a square base. The area of one of its rectangular faces is 84 cm^2 and the area of one of its square faces is 196 cm^2 .

Do not write
in this space

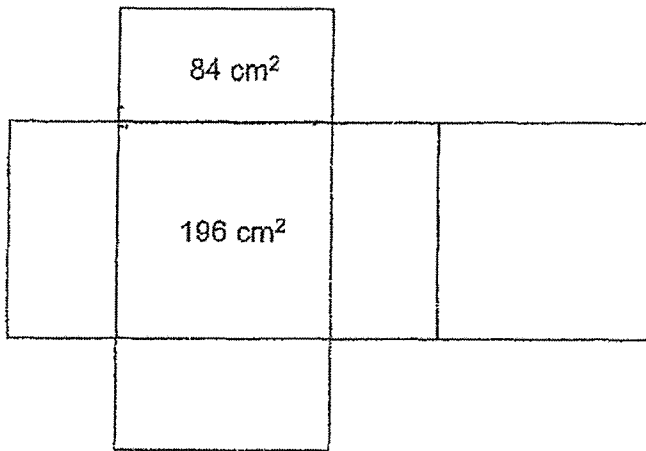

- (a) Name the solid.

Ans: (a) _____ [1]

- (b) Find the volume of the solid.

Ans: (b) _____ [2]

- (c) John took 5 of the above solid and stacked them one on top of another. What was the greatest possible height of the new solid formed?

Ans: (c) _____ [1]

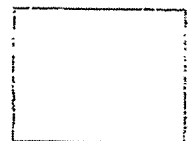

16. The first four figures of a pattern are shown below.

Do not write
in this space

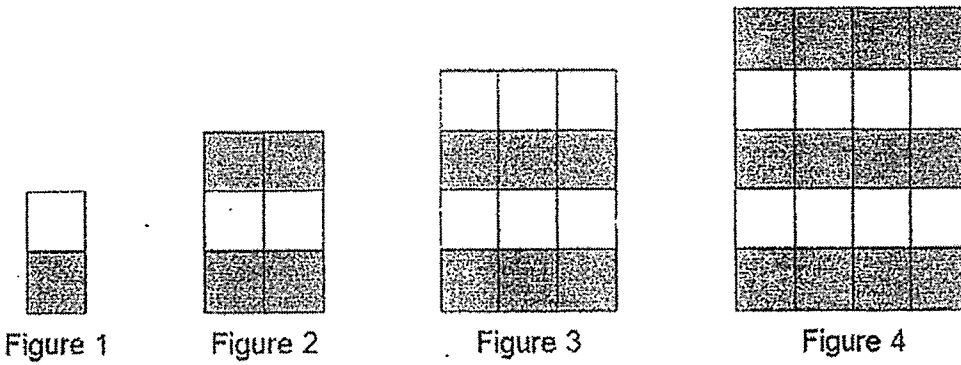

The table below shows the number of squares used for each figure.

Figure Number	Number of grey squares	Number of white squares	Total number of squares
1	1	1	2
2	4	2	6
3	6	6	12
4	12	8	20
5	(a) _____	(a) _____	30

[1]

(a) Fill in the numbers for Figure 5.

(b) How many white squares are there in Figure 15?

Ans: (b) _____ [2]

Continue Q16 on the next page.

(c) How many grey squares are there in Figure 80?

Do not write
in this space

Ans: (c) _____ [2]



17. Lily and Megan had an equal number of coins.

Lily had equal number of fifty-cent coins and twenty-cent coins. $\frac{1}{4}$ of Megan's coins were fifty-cent coins and the rest of her coins were twenty-cent coins. Lily had \$13.50 more than Megan.

(a) How many coins did each girl have?

Ans: (a) _____ [2]

(b) Megan decided to exchange all her twenty-cent coins for fifty-cent coins of the same value. What was the percentage increase in her number of fifty-cent coins?

Ans: (b) _____ [2]

Do not write
in this space



End of Paper 2

SCHOOL : Paya Lebar Methodist Girls
LEVEL : PRIMARY 6
SUBJECT : MATH
TERM : 2022 Prelim

PAPER 1 BOOKLET A

Q 1	Q2	Q3	Q4	Q5	Q6	Q7	Q8	Q9	Q10
2	3	2	1	1	3	2	3	4	1

Q 11	Q12	Q13	Q14	Q15
1	2	3	4	4

PAPER 1 BOOKLET B

Q16) $(24 - 9 \div 3) \times 5 = (24 - 3) \times 5 = 21 \times 5 = 105$
Q17) $2/3 \div 8 = 2/3 \times 1/8 = 1/12$
Q18) 7.05 am
Q19) Angle P = $360^\circ - (90^\circ + 102^\circ + 38^\circ) = 130^\circ$
Q20) $408 \div 16 = 25.5$ Number of girls = $25.5 \times 6 = 153$
Q21) a) $7/8 - 2/3 = 21/24 - 16/24 = 5/24$ b) $5m - 9 - m + 2m + 12 = 6m + 3$
Q22) $12 \times 12 \times 6 = 864 \text{ cm}^3$ $864 \text{ cm}^3 = 0.864 \text{ L}$
Q23) a) North-west b) X lies one right, one unit down of D
Q24) Shaded area = $10 \times 10 \times \frac{1}{2} \times 3.14 = 157 \text{ cm}^2$
Q25) a) S S SSSSSS b) 4
Q26) Average = $(8 + 10 + 8 + 5 + 6 + 5 + 0) \div 7 = 42 \div 7 = 6$
Q27) Angle BAC = $(180 - 100) \div 2 = 40$ Angle DAB = $180 - 62 = 118$

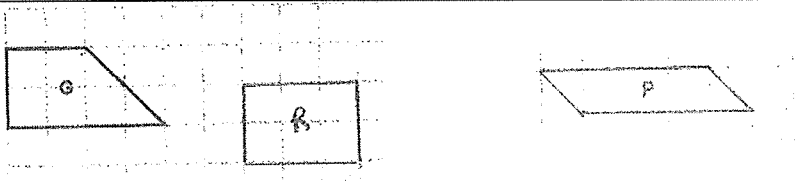
	Angle CAD = $118 - 40 = 78$
Q28)	Every 2 mins, 5 litres of water flows out of the tank $40 \% 5 = 8$ $8 \times 2 = 16$ minutes
Q29)	
Q30)	a) False b) False c) Not possible to tell

PAPER 2

Q1)	Area of ABC = $\frac{1}{2} \times 12 \times 9 = 54 \text{ cm}^2$
Q2)	$\$1185 \div 5 = \237 $\$237 \times 2 = \474
Q3)	$48^\circ + 60^\circ = 108^\circ$ $108^\circ - 22^\circ = 86^\circ$
Q4)	$875 - 120 = 255$ $255 - 121 = 134$ $134 - 121 = 13$
Q5)	$170 = 4m + m - 1 + 2m + 3$ $= 7m + 2$ $7m = 168$ $M = 24$
Q6)	$4.5 \text{ km} \div 375 = 12 \text{ min}$ $3 \text{ km} \div 12 = 250 \text{ m/min}$ Average speed = $(250 + 375) / 2 = 312.5 \text{ m/min}$
Q7)	A B G:B G:B 2:1 3:4 14:7 9:12 $345 = (14+9)u = 23u$ $U = 15$ $5u = 75$
Q8)	$25 - 9 = 16$ $16/2 = 8$ $12/2 = 6$

	$9/2 = 4 R 1$ $8 \times 6 \times 4 = 192$
Q9)	$4200 - 2400 = 1800$ $3150 - 3100 = 50$ $1800 \div 50 = 36$
Q10)	a) $5x + (U + 124) = 600$ $2x + u = 476 - 3x$ $3u + u = 476 - 4.5u$ $8.5u = 476$ $U = 56$ $3x = 4.5u = 252$ $252 : 168$ $3 : 2$ b) $252 + 124 = 376$
Q11)	a) $16 = (6u + 2u) - 4u$ $= 4u$ $U = 4$ $AC = 3u = 12 \text{ cm}$ b) Shaded area = $1/4 \times 8 \times 8 \times 3.14 = 50.24$ Square = $12 \times 12 = 144$ Percentage shaded = $50.24 / 144 \times 100\% = 34.9\%$
Q12)	A) $(180 - 98) / 2 = 41$ Angle n = $(180 - 76) - 41 = 63$ b) angle p = $76 + 63 = 139$ c) is not
Q13)	a) $40 - 12 = 28$ b) $4u = 40 + 28 + 40 = 108$ $7u = 108 \times 7 = 756$ $756 + 12 = 768$
Q14)	a) Mr Lim b) $180 - 120 = 60$ c) $80/100 \times 200 = 160$ $200 - 120 = 80$ $85\% \times 70 = 59.50$ $59.50 \times 86 = \$4760$
Q15)	a) Cuboid b) $14 \times 14 \times 6 = 1176 \text{ cm}^3$ c) $14 \times 5 = 70 \text{ cm}$
Q16)	a) 20, 15

	b) Total = $15 \times 16 = 240$ $240 \div 2 = 120$
Q17)	Grey Square $\rightarrow 3200 + 80 = 3280$ White $\rightarrow 6480 - 80 = 6400$ $6400 \div 2 = 3200$ Total $\rightarrow 80 \times 81 = 6480$

Q1)	$\text{Area of } ABC = \frac{1}{2} \times 12 \times 9 = 54 \text{ cm}^2$
Q2)	$\frac{28}{4} = 7 \text{ cm}$ $\frac{1}{2} \times \frac{32}{7} \times 14 = 22 \text{ cm}$ $\frac{1}{4} \times \frac{22}{7} \times 14 = 18$ $\text{perimeter} = 86 \text{ cm}$
Q3)	$100\% = 40$ $120\% = 48$
Q4)	$18 \times 3 = 54 \text{ cm}$ $4u = 48 \text{ cm}$ $1u = 12 \text{ cm}$
Q5)	
Q6)	(a) $QTS = 180^\circ - 37^\circ - 37^\circ = 106^\circ$ $PTQ = 180^\circ - 106^\circ = 74^\circ$ $PQT = 180^\circ - 74^\circ - 39^\circ = 67^\circ$ $SQR = 180^\circ - 67^\circ - 37^\circ = 76^\circ$ $QSR = 180^\circ - 76^\circ - 66^\circ = 38^\circ$ (b) is not & is not
Q7)	$\frac{1}{2} \times 3.14 \times 5 \times 5 = 39.25 \text{ cm}^2$ $\frac{1}{4} \times 3.14 \times 20 \times 20 = 314 \text{ cm}^2$ $314 - 39.25 - 39.25 = 235.5 \text{ cm}^2$

<p>Q8)</p> <ul style="list-style-type: none"> - Not possible to tell - False - True 	$b = \frac{1}{2} \text{ of area of } x$ $\text{area of } x = 5 \times 2 = 10$ $\text{area of } c = 5 - 1 = 4$
	<p>Q9)</p> $\frac{1}{4} \times \frac{22}{7} \times 14 = 11\text{cm}$ $11 + 7 = 18\text{cm}$ $125 - 11 = 114$ $114 - 21 - 21 = 72\text{cm}$ $\frac{72}{2} = 36\text{cm}$
	<p>Q10)</p> $\frac{1}{2} \times \frac{3}{14} \times 8 \times 8 = 110.48\text{cm}^2$ $(16 \times 16) \times 2 = 512\text{cm}^2$ $16 \times 8 = 128\text{cm}^2$ $\text{total} = 128 + 100.48 + 100.48 + 512 = 840.96\text{cm}^2$
<p>Q11) (a) $10u = \\$2000$</p> <p>(b) <i>March transport</i> = $\frac{10}{100} \times 2000 = \\200</p> <p><i>shopping</i> = $\frac{60}{100} \times 2000 = \\1200</p> <p><i>food</i> = $\\$2000 - \\$1200 - \\$200 = \\600</p> <p><i>April transport</i> = $\\$200$</p> <p><i>shopping</i> = $\frac{90}{100} \times \\$1200 = \\1080</p> <p>80% = $\\$1080 + \\$200 = \\$1280$</p> <p>100% = $\\$16 \times 100 = \\1600</p>	$3u = \$600$
<p>Q12) (a) $60 \div 5 = 15$</p> <p>(b) $23 \div 2 = 11.5$</p>	$15 \times 2 = 30\text{cm}$ $4 \div 2 = 2$ $5 \div 2 = 2.5$ $11 \times 2 \times 2 = 44$
<p>Q13) (a) <i>AOB</i></p> <p>(b) <i>OBA</i> = $(180 - 90) \div 2 = 45$</p> <p>(C) <i>BOC</i> = $180 - 58 - 58 = 64$</p>	$OBC = 58$ $ABC = 58 - 45 = 13$ $AOC = 90 - 64 = 26$

Q14)

$$\begin{aligned} \text{choco left} &= \frac{1}{6} \text{ of } \frac{3}{4} = \frac{1}{8} \\ \text{butter left} &= \frac{1}{5} - \frac{1}{8} = \frac{3}{40} \\ \text{butter sold} &= \frac{1}{4} - \frac{3}{40} = \frac{7}{40} \\ \frac{7}{40} &= 105 \\ \frac{1}{40} &= 15 \\ \frac{40}{40} &= 600 \end{aligned}$$

Q15) (a) $m:w = 23:5$

$$\begin{aligned} 23u &= 46 \\ 1u &= 46 \div 23 = 2 \\ 8u &= 16 \end{aligned}$$

(b) $\frac{1}{3}$ of $M = 16$

$$\begin{aligned} \text{men} &= 16 \times 3 = 48 \\ 4u &= 48 \\ 3u &= 36 \end{aligned}$$

Q16) (a) jerry had 6 more kaya buns = $6 \times 50\text{cents} = 300\text{cents}$

$$\text{total diff} = 300\text{cents} + 90\text{cents} = 390\text{cents}$$

$$\text{per diff} = 80\text{cents} - 50\text{cents} = 30\text{cents}$$

$$\text{no. of buns} = 390\text{cents} \div 30\text{cents} = 13$$

(b) jerry = $13 + 6 = 19$

$$\text{cost} = 19 \times 50\text{cents} = \$9.50$$

Q17) (a) $P = 3 \times 4 = 12\text{cm}$

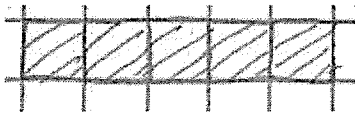

(b)

(c) largest area = $7 \times 8 = 56\text{cm}^2$