



**NAN HUA PRIMARY SCHOOL  
PRELIMINARY EXAMINATION 2022  
PRIMARY 6**

**MATHEMATICS  
PAPER 1  
(BOOKLET A)**

**Total Time for Booklets A and B: 1 hour**

**INSTRUCTIONS TO CANDIDATES**

1. Write your name and index number in the space provided.
2. Do not turn over the page until you are told to do so.
3. Follow all instructions carefully.
4. Answer all questions.
5. Shade your answers in the Optical Answer Sheet (OAS) provided.
6. The use of calculators is **NOT** allowed.

Name : \_\_\_\_\_ (       )

Class : 6 \_\_\_\_\_

Date : 24 August 2022

Parent's Signature : \_\_\_\_\_

*This booklet consists of 8 printed pages and 2 blank pages.*

**BLANK PAGE**

Questions 1 to 10 carry 1 mark each. Questions 11 to 15 carry 2 marks each.  
 For each question, four options are given. One of them is the correct answer.  
 Make your choice (1, 2, 3 or 4) and shade your answer on the Optical Answer Sheet.  
 (20 marks)

---

1 Round 56 354 to the nearest 1000.

- (1) 56 000
- (2) 56 300
- (3) 56 400
- (4) 57 000

2 In 18.624, which digit is in the tenths place?

- (1) 1
- (2) 2
- (3) 6
- (4) 8

3 Arrange the following numbers from the smallest to the largest.

7	7.3	7.03	
---	-----	------	--

- |     | <u>Smallest</u> | , |      | , | <u>Largest</u> |
|-----|-----------------|---|------|---|----------------|
| (1) | 7               |   | 7.03 |   | 7.3            |
| (2) | 7.3             |   | 7    |   | 7.03           |
| (3) | 7.3             |   | 7.03 |   | 7              |
| (4) | 7.03            |   | 7.3  |   | 7              |

4 Express  $\frac{1}{8}$  as a decimal.

(1) 0.125

(2) 1.25

(3) 12.5

(4) 125

5 In a marathon, there are 40 Malay participants, 70 Chinese participants and 30 Indian participants. What is the ratio of the number of Malay participants to the total number of Chinese and Indian participants?

(1) 2 : 5

(2) 2 : 7

(3) 4 : 3

(4) 4 : 7

6 John is thinking of a number. 40% of the number is 36. What is the number?

(1) 9

(2) 18

(3) 54

(4) 90

- 7 Aini spent \$40 in school in January. In February, she spent \$32 in school. Find the percentage decrease in her spending.
- (1) 8 %
  - (2) 20 %
  - (3) 25 %
  - (4) 72 %
- 8 Simplify  $9 + 5d - 3d + 4$ .
- (1)  $5 + 2d$
  - (2)  $5 + 8d$
  - (3)  $13 + 2d$
  - (4)  $13 + 8d$
- 9 Which of the following is the most likely mass of a calculator shown below?
- (1) 5 g
  - (2) 15 g
  - (3) 150 g
  - (4) 1500 g



10 Which of the following is the same as 8050 cm?

- (1) 8 m 5 cm
- (2) 8 m 50 cm
- (3) 80 m 5 cm
- (4) 80 m 50 cm

11 Below are the operating hours of ABC Dental Clinic.

**ABC Dental Clinic**

Opens Monday to Friday  
Closed on weekends

8.30 a.m. to 12.30 p.m.

2.30 p.m. to 4.30 p.m.

7 p.m. to 9.15 p.m.

How long is the clinic open on Wednesday?

- (1) 9 h 15 min
- (2) 8 h 15 min
- (3) 7 h 15 min
- (4) 6 h 15 min

- 12 The figure shows a circle inside a square of side 14 cm.

Find the area and perimeter of the circle. Take  $\pi = \frac{22}{7}$ .

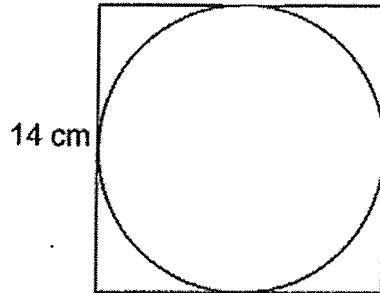

	<u>Area</u>	<u>Perimeter</u>
(1)	154 cm <sup>2</sup>	44 cm
(2)	154 cm <sup>2</sup>	22 cm
(3)	44 cm <sup>2</sup>	154 cm
(4)	22 cm <sup>2</sup>	154 cm

- 13 Mrs Lim had  $\frac{2}{5}$  ℓ of syrup. She mixed the syrup with  $\frac{9}{10}$  ℓ of water to make fruit punch. The fruit punch was poured into bottles, each containing  $\frac{1}{5}$  ℓ. How much fruit punch was left?

- (1)  $\frac{1}{10}$  ℓ
- (2)  $\frac{1}{2}$  ℓ
- (3)  $\frac{3}{10}$  ℓ
- (4)  $\frac{11}{10}$  ℓ

- 14 The graph below shows the number of books that the students in Class 6A read in a week.

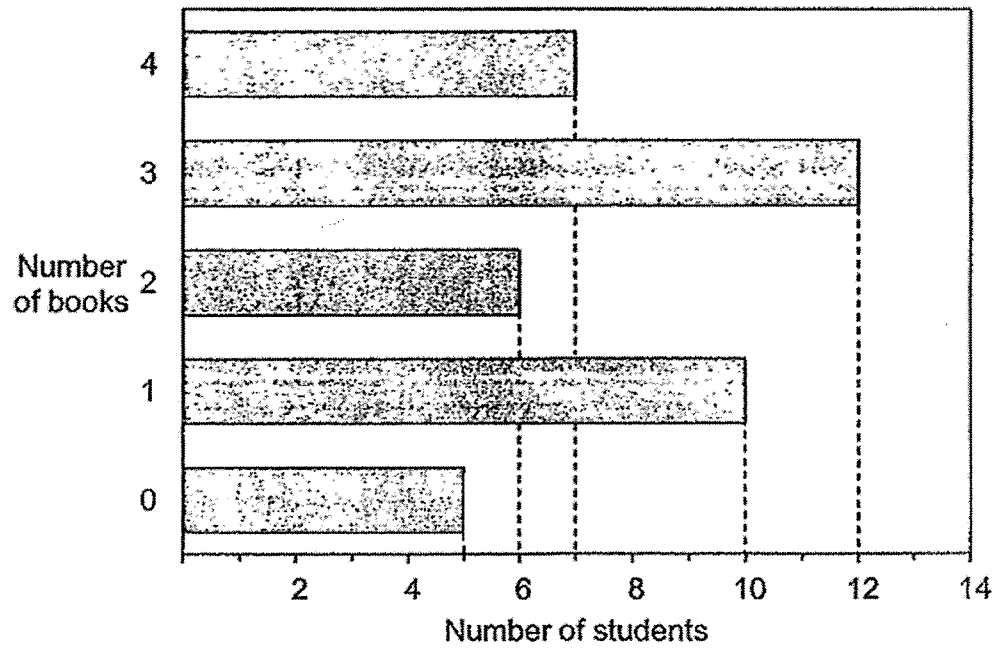

Find the total number of books read by students who read more than 2 books.

- (1) 19
- (2) 25
- (3) 64
- (4) 76



- 15 Halim's result slip was accidentally torn. His average mark for 4 subjects is 78. Part of his Mathematics and Science marks are missing. What is the greatest possible difference between Halim's Mathematics and Science mark?

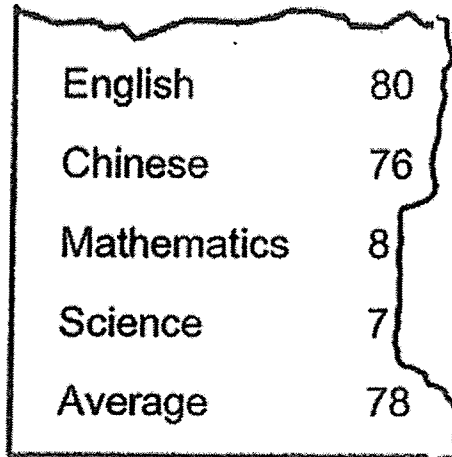

English	80
Chinese	76
Mathematics	8
Science	7
Average	78

- (1) 19  
(2) 16  
(3) 10  
(4) 4

(Go on to Booklet B)

**BLANK PAGE**

## ERRATA

Name : \_\_\_\_\_ (       )

Class : 6 \_\_\_\_\_

Replace Page 7 Question 13 with the following question

- 13 Mrs Lim had  $\frac{1}{10}$  ℓ of syrup. She mixed the syrup with  $\frac{4}{5}$  ℓ of water to make fruit punch. The fruit punch was poured into bottles, each containing  $\frac{1}{5}$  ℓ. How much fruit punch was left?

(1)  $\frac{1}{10}$  ℓ

(2)  $\frac{1}{2}$  ℓ

(3)  $\frac{7}{10}$  ℓ

(4)  $\frac{4}{5}$  ℓ





NAN HUA PRIMARY SCHOOL  
PRELIMINARY EXAMINATION 2022  
PRIMARY 6

MATHEMATICS  
PAPER 1  
(BOOKLET B)

Total Time for Booklets A and B: 1 hour

**INSTRUCTIONS TO CANDIDATES**

1. Write your name and index number in the space provided.
2. Do not turn over the page until you are told to do so.
3. Follow all instructions carefully.
4. Answer all questions.
5. Write your answers in this booklet.
6. The use of calculators is **NOT** allowed.

**Marks Obtained**

Paper 1	Booklet A		/ 45
	Booklet B		
Paper 2			/ 55
Total			/ 100

Name : \_\_\_\_\_ (            )

Class : 6 \_\_\_\_\_

Date : 24 August 2022

Parent's Signature: \_\_\_\_\_

*This booklet consists of 12 printed pages and 2 blank pages.*

**BLANK PAGE**

Questions 16 to 20 carry 1 mark each. Write your answers in the spaces provided.  
For questions which require units, give your answers in the units stated. (5 marks)

Do not write  
in this space

16 Measure and write down the size of  $\angle ABC$ .

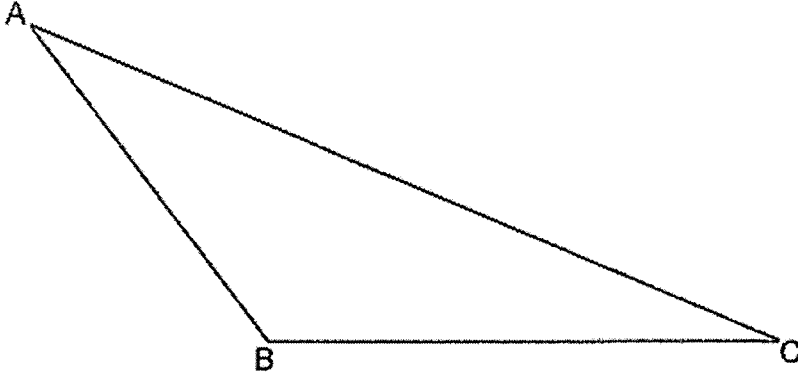

Ans : \_\_\_\_\_ °

17 The volume of the cuboid is  $96 \text{ cm}^3$ . The area of the shaded face is  $8 \text{ cm}^2$ . Find the height of the cuboid.

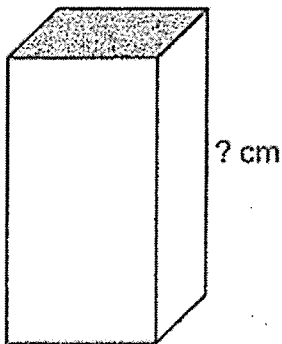

Ans : \_\_\_\_\_ cm

(Go on to the next page)

18 Figure A and B are nets of solids.

Do not write  
in this space

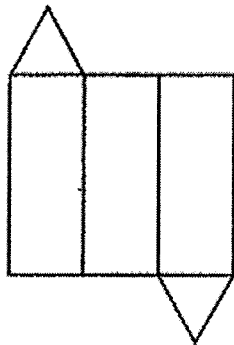

Figure A

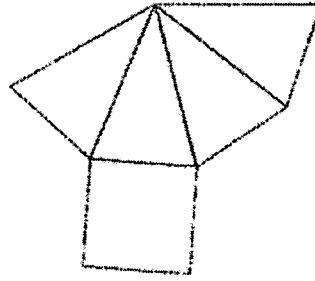

Figure B

Circle the words that describe the figures above.

Figure A is a net of a ( prism / pyramid ).

Figure B is a net of a ( prism / pyramid ).

19 There are 4 shaded squares in the figure. Shade 3 more squares to form a symmetric figure with AB as the line of symmetry.

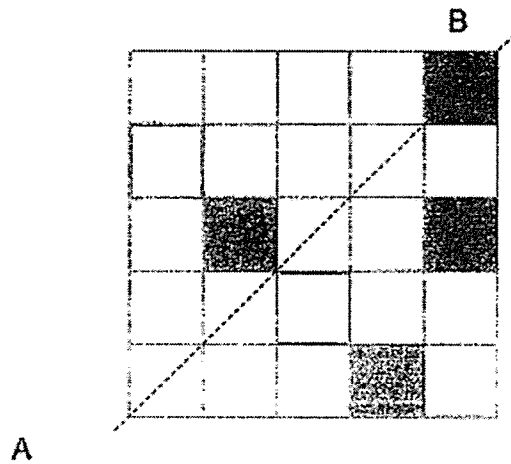

A

B



20 ABCD is a trapezium with AB parallel to DC. Find  $\angle y$ .

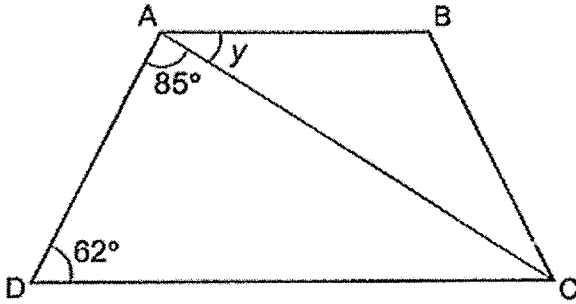

Do not write  
in this space

Ans : \_\_\_\_\_ °

(Go on to the next page)

Questions 21 to 30 carry 2 marks each. Show your working clearly and write your answers in the spaces provided. For question which require units, give your answers in the units stated. (20 marks)

Do not write  
in this space

21 (a) Find the value of  $\frac{2}{7} \div 4$ .

Give your answer in fraction in the simplest form.

Ans : (a) \_\_\_\_\_

(b) Find the value of  $2 \div 9$ .  
Give your answer correct to 1 decimal place.

Ans : (b) \_\_\_\_\_

- 22 (a) Which fraction is smaller?

Do not write  
in this space

$\frac{4}{9}$	$\frac{2}{3}$
---------------	---------------

Ans : (a) \_\_\_\_\_

- (b) Arrange  $\frac{5}{9}$ ,  $\frac{2}{3}$ ,  $\frac{9}{8}$  in decreasing order.

Ans : (b) \_\_\_\_\_ , \_\_\_\_\_ , \_\_\_\_\_

(Go on to the next page)

23 The square grid shows the positions of points A, B, C, D, E, F, G and H.

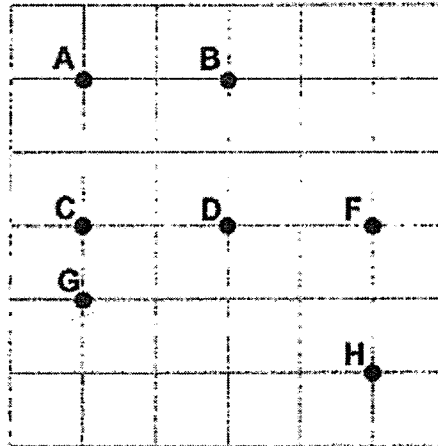

Do not write  
in this space

(a) In which direction is point A from point D?

Ans : (a) \_\_\_\_\_

(b) Winnie is at point B facing East at first. She turns  $135^\circ$  clockwise. Which point is she facing after the turn?

Ans : (b) \_\_\_\_\_



- 24 A box contains red, green, blue and black markers.  
 $\frac{3}{8}$  of the markers are red.  $\frac{3}{10}$  of the remaining markers are green. The number of blue and black markers are equal.  
What fraction of the markers in the box are blue?

Do not write  
in this space

Ans : \_\_\_\_\_

- 25 John is  $t$  years old. His mother is 25 years older than him.

- (a) How old is John's mother?  
Express your answer in terms of  $t$ .

Ans : (a) \_\_\_\_\_ years old

- (b) What is their total age when  $t = 10$ ?

Ans : (b) \_\_\_\_\_ years old

(Go on to the next page)

26 Draw the following cuboid on the isometric grid.

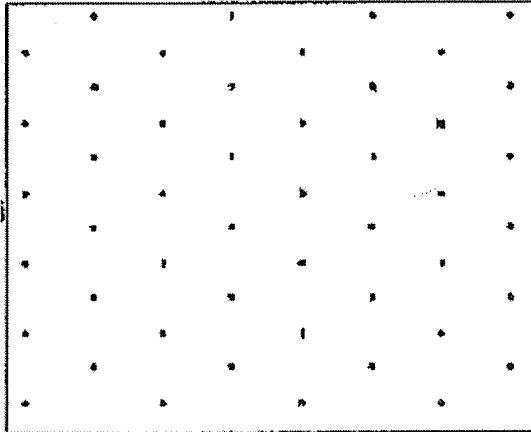
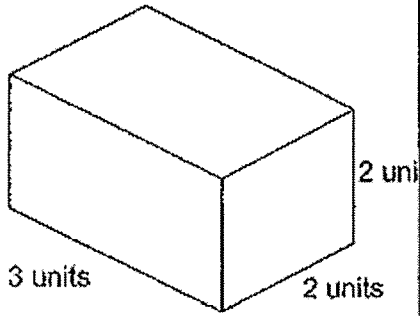

Do not write  
in this space

27 The figure shows a rectangular glass box filled with unit cubes. How many more unit cubes are needed to fill the box completely?

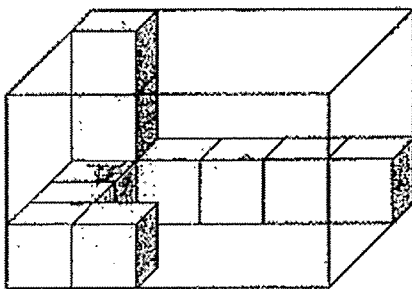

Ans : \_\_\_\_\_

- 28 In the figure, ABCD is a square. BCE is an equilateral triangle.  
Find  $\angle AEB$ .

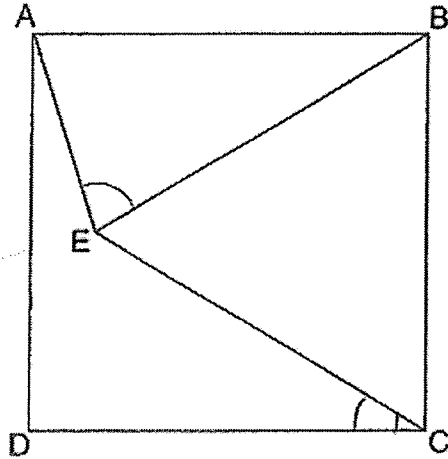

Do not write  
in this space

Ans : \_\_\_\_\_ °

29 A triangle ABC is drawn on a square grid.

Do not write  
in this space

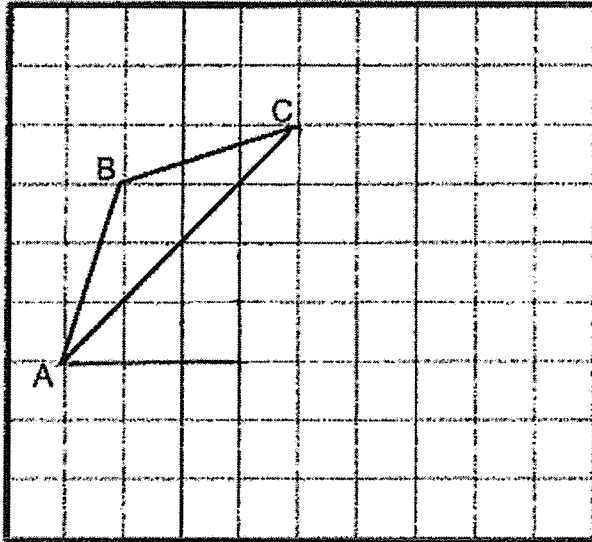

- (a) Using triangle ABC, draw rhombus ABCD.
- (b) Draw a triangle ACE such that area of ABC is  $\frac{1}{3}$  of the area of ACE.  
Triangle ACE must not overlap with triangle ABC.





- 30 The figure below is made up of 3 identical squares, ABCD, BEFG and BHJK.  $\angle ABG = 40^\circ$  and  $\angle HBE = 30^\circ$ . Find  $\angle KBC$ .

Do not write  
in this space

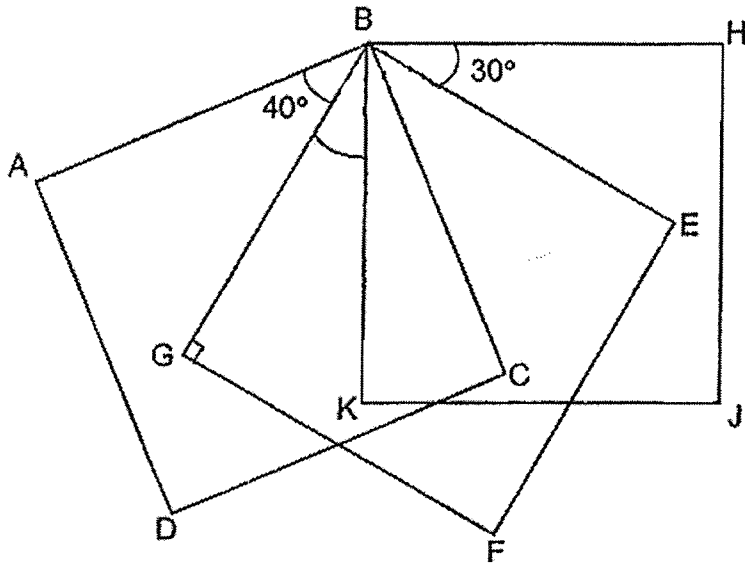

Ans : \_\_\_\_\_ °

End of Paper

**BLANK PAGE**



**NAN HUA PRIMARY SCHOOL  
PRELIMINARY EXAMINATION 2022  
PRIMARY 6**

**MATHEMATICS  
Paper 2**

**Total Time for Paper 2: 1 hour 30 minutes**

**INSTRUCTION TO CANDIDATES**

1. Write your name and index number in the space provided.
2. Do not turn over the page until you are told to do so.
3. Follow all instructions carefully
4. Answer all questions.
5. Write your answers in this booklet.
6. The use of an approved calculator is allowed.

**Marks Obtained**

Total	Max Mark
	55

Name : \_\_\_\_\_ (            )

Class : 6 \_\_\_\_\_

Date : 24 August 2022

Parent's Signature : \_\_\_\_\_

*This booklet consists of 16 printed pages and 2 blank page.*

**BLANK PAGE**

Questions 1 to 5 carry 2 marks each. Show your working clearly and write your answers in the space provided. For questions which require units, give your answers in the units stated. (10 marks)

Do not write in this space

- 1 The mass of a watermelon is 4.82 kg. The mass of a pineapple is 2.65 kg lighter than the mass of the watermelon.  
What is the total mass of the two fruits?

Ans: \_\_\_\_\_ kg

- 2 The figure shows a square divided into two rectangles A and D and two squares B and C. The perimeter of rectangle A is 14 cm.  
Find the value of  $p$ .

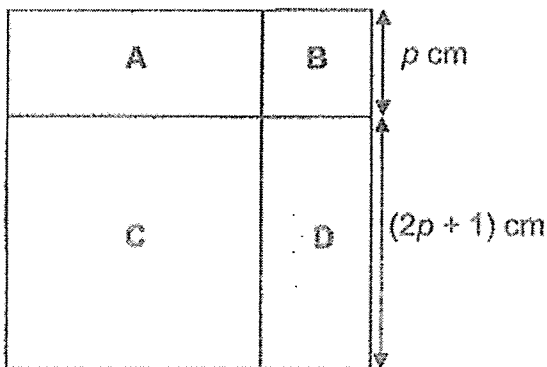

Ans:  $p =$  \_\_\_\_\_ cm

(Go on to the next page)

- 3 Mrs Lee had a sum of money to spend. She spent  $\frac{1}{2}$  of her money plus \$2 on a notebook. Next, she spent  $\frac{1}{4}$  of her remaining money on a drink and she was left with \$9. How much money did she have at first?

Do not write  
in this space

Ans: \$ \_\_\_\_\_

- 4 The figure below is made of a square BEFG and 2 triangles ABH and CBD. ABE, HBD and GBC are straight lines. Find the value of  $\angle a + \angle b + \angle c + \angle d$ .

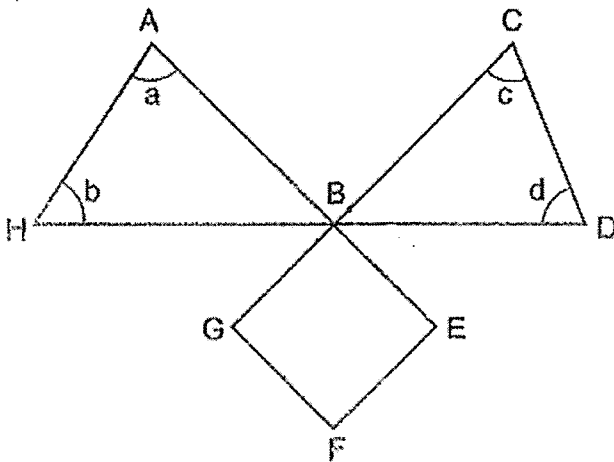

Ans: \_\_\_\_\_°

- 5 The figure below shows 2 containers, A and B.  
 Container A contains 10 l of water.  
 Container B has a base area of  $1000 \text{ cm}^2$  and was empty at first.

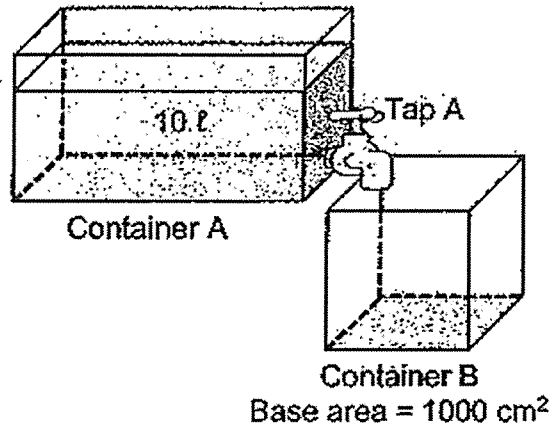

When Tap A is turned on, the height of water in container B increases by 2 cm per minute. What is the volume of the water left in container A after Tap A is turned on for 2 minutes?

Ans: \_\_\_\_\_ l

Do not write  
in this space

(Go on to the next page)

For questions 6 to 17, show your working clearly and write your answers in the spaces provided. The number of marks available is shown in brackets [ ] at the end of each question or part-question. (45 marks)

Do not write  
in this space

- 6 Muffins are sold in boxes of 6, 8 and 15. John bought 12 boxes of 6 muffins and some boxes of 8 and 15 muffins. He bought a total of 188 muffins. How many boxes of 15 muffins did John buy?

Ans: \_\_\_\_\_ [3]

- 7 A red T-shirt is sold at a 15% discount and a blue T-shirt at a 30% discount. Both shirts have the same price before the discount. The discounted price of the red T-shirt is \$6 more than the discounted price of the blue T-shirt. What is the price of a red T-shirt before the discount?

Ans: \_\_\_\_\_ [3]



- 8 The figure below is made up of 9 squares of sides 3 cm. Triangle ABC is shaded.

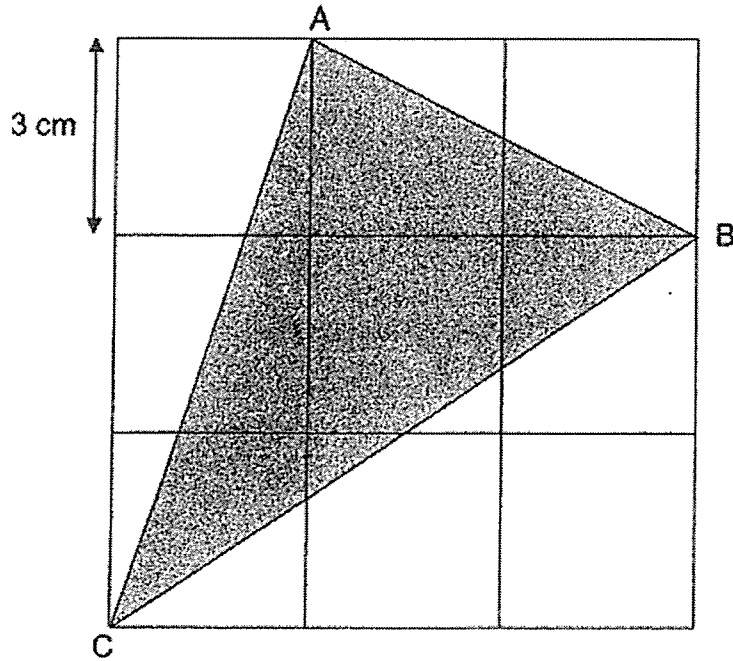

Do not write  
in this space

- (a) Find the area of unshaded part.

Ans: (a) \_\_\_\_\_ [2]

- (b) Find the area of shaded part.

Ans: (b) \_\_\_\_\_ [1]



(Go on to the next page)

- 9 In the figure below, ABCD is a parallelogram and DBF is an isosceles triangle with  $FD = FB$ .  $\angle DFB = 70^\circ$  and  $\angle DEB = 86^\circ$ . Find  $\angle BDC$ .

Do not write  
in this space

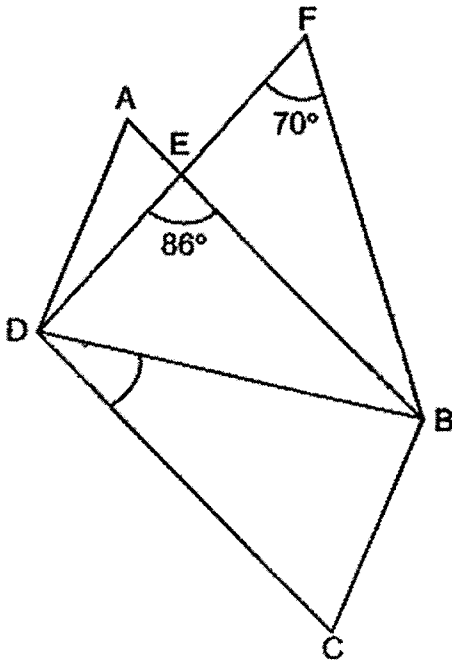

Ans: \_\_\_\_\_ [3]





- 10 The ratio of the number of apples to the number of pears in a supermarket was 5 : 6.  $\frac{1}{4}$  of the apples and 171 pears were rotten. The rotten apples and pears were thrown away. In the end, there was an equal number of apples and pears left. How many apples were there at first?

Do not write  
in this space

Ans: \_\_\_\_\_ [4]

- 11 James bought key chains and trading cards at the prices shown below.

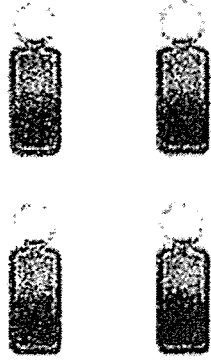
Do not write  
in this space

	
Key Chain 4 for \$17	Trading Card 3 for \$8

He bought an equal number of keychains and trading cards. He spent \$76 more on keychains than trading cards. How many key chains did he buy?

Ans: \_\_\_\_\_ [3]



- 12 Town A and B are 400 km apart. Alex left Town A for Town B travelling at a constant speed of 65 km/h. At the same time, Ben left Town B for Town A, travelling at a constant speed of 85 km/h. Both of them took the same route. How long did they take to pass each other? Leave your answers in hours and minutes.

Do not write  
in this space

Ans: \_\_\_\_\_ [3]

- 13 In the figure below,  $ACFH$  and  $BDGJ$  are identical parallelograms.  $EFH$  is a triangle.  $ABCD$  and  $JHGF$  are straight lines. Given that  $\angle CDE = 65^\circ$  and  $\angle CEH = 100^\circ$ ,

Do not write in this space

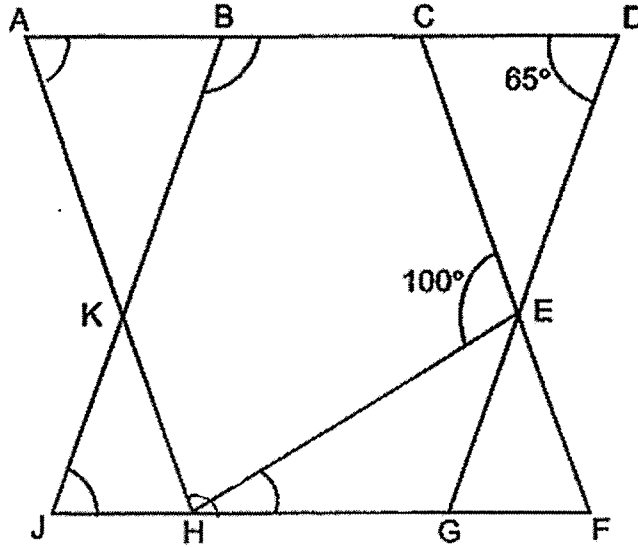

- (a) Find  $\angle BJH$ .

Ans: (a) \_\_\_\_\_ [1]

- (b) Find  $\angle DBJ$ .

Ans: (b) \_\_\_\_\_ [1]

- (c) Find  $\angle EHF$ .

Ans: (c) \_\_\_\_\_ [2]



14. The graph shows the charges for water usage.

Do not write  
in this space

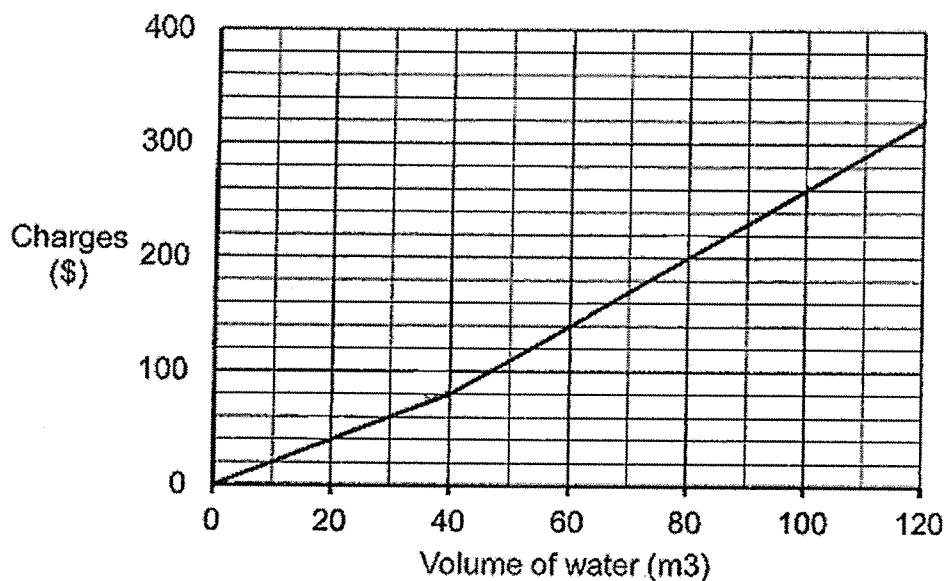

- (a) Find the charges when 40 m<sup>3</sup> of water is used.

Ans: (a) \_\_\_\_\_ [1]

- (b) The Lee family paid \$260 for the volume of water used in July. What was the volume of water used?

Ans: (b) \_\_\_\_\_ [1]

- (c) How much is the charge for every cubic metre of water after 40 m<sup>3</sup>?

Ans: (c) \_\_\_\_\_ [2]

- 15 The bar graph below represent how Bryan used his money in September. The amount of money is not shown on the scale in the bar graph below.

Do not write in this space

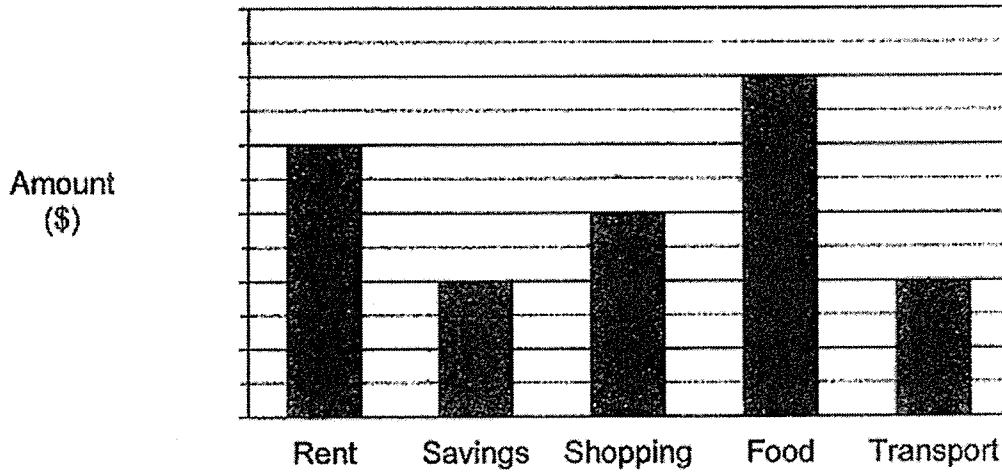

How Bryan used his money in September is also represented in the pie chart below.

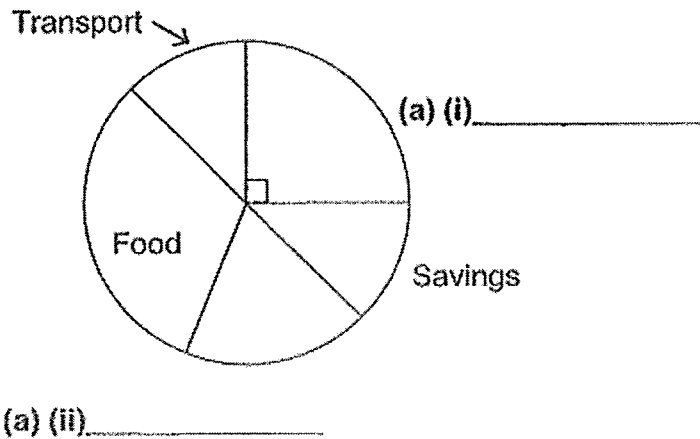

- (a) Label the pie chart by writing 'Shopping' and 'Rent' in the blanks above. [1m]



- (b) Each of the statements below is either true, false or impossible to tell from the information given. For each statement, put a tick ( $\checkmark$ ) to indicate your answer.

Do not write  
in this space

Statement	True	False	Not possible to tell
The amount spent on rent is twice the amount spent on transport.			
The ratio of the amount spent on shopping to the amount spent on food is 3 : 4.			

[2]

- (c) What fraction of his money did he spend on shopping?

Ans: (c) \_\_\_\_\_ [2]

16 Mrs Chan used white and grey coloured papers to form figures that follow a pattern as shown below.

Do not write in this space

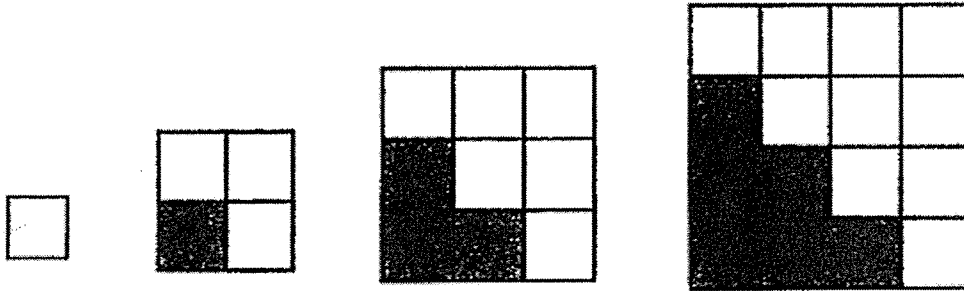

Figure 1

Figure 2

Figure 3

Figure 4

The table below shows the number of white and grey coloured papers for the first four figures.

(a) Fill in the table for Figure 5.

Figure Number	1	2	3	4	5
Number of white coloured paper	1	3	6	10	
Number of grey coloured paper	0	1	3	6	
Total number of paper	1	4	9	16	

[3]

(b) How many white and grey coloured papers are there in Figure 20 altogether?

(b) \_\_\_\_\_ [1]

(c) A figure in the pattern has a total of 1444 white and grey coloured papers. What is the Figure Number?

(c) \_\_\_\_\_ [1]



- 17 Figure A and B are made up of identical quarter circles.

Do not write  
in this space

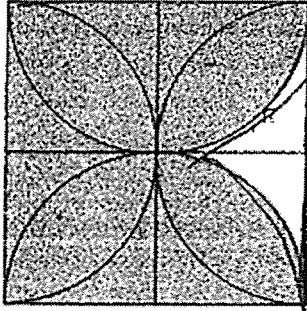

Figure A

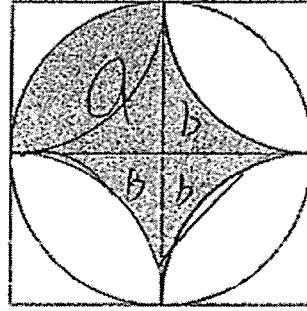

Figure B

The perimeter of the shaded part of Figure A is 140 cm more than the perimeter of the unshaded part of A.

Find the area of the total shaded part in Figure B. Take  $\pi = \frac{22}{7}$ .

Ans: \_\_\_\_\_ [5]



End of Paper

**BLANK PAGE**

**NAN HUA PRIMARY SCHOOL  
PRELIMINARY EXAMINATION 2022  
MATHEMATICS  
PRIMARY 6**

**Paper 1**

1)	1	6)	4	11)	2
2)	3	7)	2	12)	1
3)	1	8)	3	13)	1
4)	1	9)	3	14)	3
5)	1	10)	4	15)	2

**Section B (20 marks)**

Questions 16 to 20 carry 1 mark each.

Questions 21 to 30 carry 2 marks each.

(For Q21 to Q30, 1 mark will be awarded for the final method mark even if the answer is wrong. A2 will be awarded for the correct answers as some pupils might do the questions mentally.)

16)	$127 \pm 1^\circ$
17)	12
18)	Figure A $\rightarrow$ prism Figure $\rightarrow$ pyramid
19)	Refer to picture
20)	33

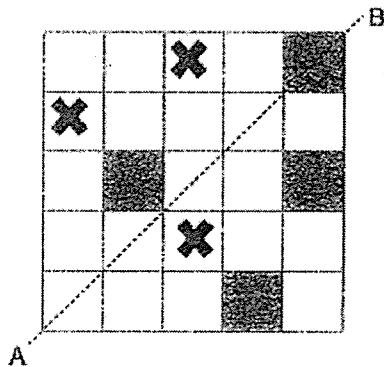

**Note: Q21 to 30 carry 2 marks each**

21. a)  $\frac{1}{14}$

b) 0.2

22. a)  $\frac{4}{9}$

b)  $\frac{9}{8}, \frac{2}{3}, \frac{5}{9}$

23. a) North- West

b) C

24.  $\frac{7}{10} \times \frac{5}{8} = \frac{7}{16}$  (blue and black)

$$\frac{7}{16} \div 2 = \frac{7}{32}$$

25. a)  $(t + 25)$  years old or  $(25 + t)$  years old

b) 45 years

26.

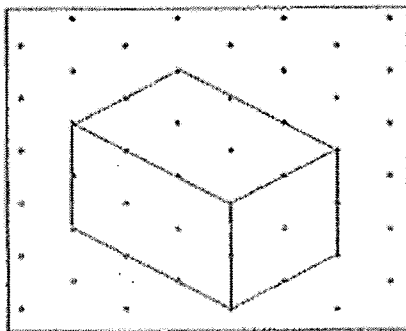

27.  $5 \times 4 \times 3 = 60$

$$60 - 11 = 49$$

28.  $90^\circ - 60^\circ = 30^\circ$

$$180^\circ - 30^\circ = 150^\circ$$

$$150^\circ \div 2 = 75^\circ$$

29.

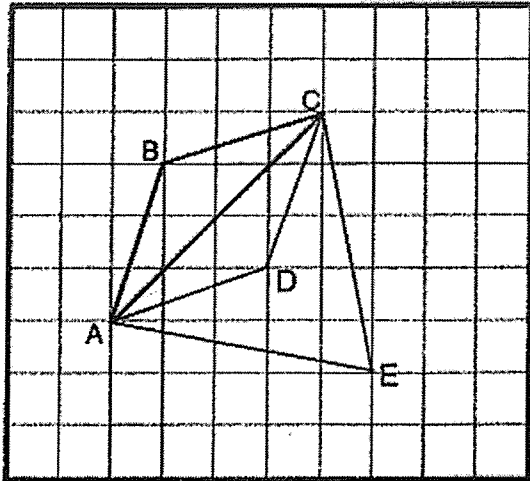

30.  $\angle GBK = \angle HBE = 30^\circ$

$$\angle KBC = 90^\circ - 40^\circ - 30^\circ = 20^\circ$$

Paper 2

1.	$4.82 - 2.65 = 2.17$ $4.82 + 2.17 = 6.99$								
2.	$2p + 1 + 2p + 1 + p + p = 6p + 2$ $6p + 2 = 14$ $p = (14 - 2) \div 6$ $= 2$								
3.	$9 \div 3 = 3$ $2 + 3 \times 4 = 14$ $14 \times 2 = 28$								
4.	$180^\circ + 180^\circ = 360^\circ$ (sum of 2 triangles) $360^\circ - 90^\circ = 270^\circ$								
5.	$2 \times 2 \times 1 = 4$ $10 - 4 = 6$								
6.	$12 \times 6 = 72$ $188 - 72 = 116$ Using guess and check method, <table border="1" data-bbox="352 1010 1150 1081"> <thead> <tr> <th>6 muffins</th> <th>8 muffins</th> <th>15 muffins</th> <th>total</th> </tr> </thead> <tbody> <tr> <td><math>12 \times 6 = 72</math></td> <td><math>7 \times 8 = 56</math></td> <td><math>4 \times 15 = 60</math></td> <td>188</td> </tr> </tbody> </table>	6 muffins	8 muffins	15 muffins	total	$12 \times 6 = 72$	$7 \times 8 = 56$	$4 \times 15 = 60$	188
6 muffins	8 muffins	15 muffins	total						
$12 \times 6 = 72$	$7 \times 8 = 56$	$4 \times 15 = 60$	188						
7.	$85\% - 70\% = 15\%$ $15\% \rightarrow \$6$ $5\% \rightarrow \$2$ $100\% \rightarrow \$2 \times 20 = \$40$								
8.	a) $(\frac{1}{2} \times 3 \times 9) + (\frac{1}{2} \times 3 \times 6) + (\frac{1}{2} \times 6 \times 9) = 49.5 \text{ cm}^2$ b) $9 \times 9 = 81$ $81 - 49.5 = 31.5 \text{ cm}^2$								
9.	$\angle FDB = (180^\circ - 70^\circ) \div 2$ $= 55^\circ$ $\angle BDC = \angle EBD = 180^\circ - 55^\circ - 86^\circ$ $= 39^\circ$								



10.	$A : P = 5 : 6$ $= 20 : 24$  $RA = 20 \times \frac{1}{4} = 5$ $RP = 24 - 15 = 9$  9 units = 171 1 unit = 19 20 units = $19 \times 20$ = 380
11.	1 set of 12 keychains $\rightarrow \$17 \times 3 = \$51$ 1 set of 12 trading cards $\rightarrow \$8 \times 4 = \$32$ Difference of 1 set = $\$51 - \$32 = \$19$ $\$76 \div \$19 = 4$ $4 \times 12 = 48$
12.	$65 + 85 = 150$ $400 \div 150$ $= 2\frac{2}{3} \text{ h} = 2\text{h } 40 \text{ min}$
13. (a)	$\angle BJH = 65^\circ$
(b)	$\angle DBJ = 180^\circ - 65^\circ = 115^\circ$
(c)	$\angle EHF = 100^\circ - 65^\circ = 35^\circ$
14. (a)	\$90
(b)	$100 \text{ m}^3$
(c)	M1 for identifying the correct corresponding x and y value  $(200 - 140) / (80 - 60)$ = \$3

15. (a)	Rent
(aii)	Shopping
(bi)	true
(bii)	false
(c)	$\frac{6}{32} = \frac{3}{16}$
16. (a)	(i) 15 (ii) 10 (iii) 25
(b)	$(20 \times 20) = 400$
(c)	$38 \times 38 = 1444$
17.	$4r = 140$ $35 \times 35 = 1225$ $\frac{1}{4} \times \frac{22}{7} \times 35 \times 35 = 962.5$ $1225 - 962.5 = 262.5$ $35 \times 35 + 962.5 = 1750 \text{ cm}^2$