

SINGAPORE CHINESE GIRLS' SCHOOL (PRIMARY)

SECOND SEMESTRAL ASSESSMENT 2021

NAME: _____ ()

DATE: 26 October 2021

CLASS: PRIMARY 5 SY

Parent's Signature:

SCIENCE
BOOKLET A

28 questions

56 marks

Total time for Booklets A & B: 1 h 45 min

DO NOT OPEN THIS BOOKLET UNTIL YOU ARE TOLD TO DO SO.

FOLLOW ALL INSTRUCTIONS CAREFULLY.

Part I (56 marks)

For each question from 1 to 28, four options are given. One of them is the correct answer. Make your choice (1, 2, 3 or 4). **Shade the correct oval (1, 2, 3 or 4) on the Optical Answer Sheet.**

1. The pictures below show 2 animals.



Frog

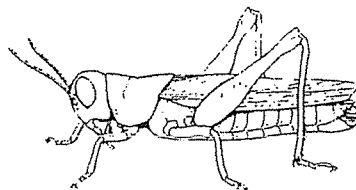

Grasshopper

How are these animals similar?

- 1) Both lay eggs.
- 2) Both have six legs.
- 3) Both have moist skin.
- 4) Both live on land and in water.

2. Study the flowchart below.

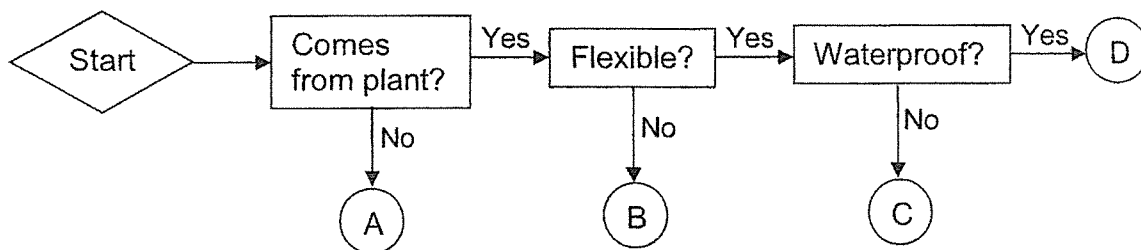

What can objects A, B, C and D be?

	A	B	C	D
1)	needle	wooden chopsticks	rubber gloves	newspaper
2)	newspaper	needle	wooden chopsticks	rubber gloves
3)	needle	wooden chopsticks	newspaper	rubber gloves
4)	rubber gloves	newspaper	wooden chopsticks	needle

3. Organ X is part of the digestive system. Its characteristics are listed below.

Organ X:

- Digestion does not take place here
- Undigested food becomes solid waste after passing through it

What will happen if organ X does **not** function properly?

- 1) Digested food will not be absorbed into the blood.
- 2) Food will not be completely digested.
- 3) Energy cannot be released from the food.
- 4) Watery waste will be passed out.

4. Which of the following has been **incorrectly** matched?

	Human systems	Descriptions
1)	Skeletal	Protects vital organs in the body
2)	Circulatory	Transports oxygen to all parts of the body
3)	Respiratory	Absorbs carbon dioxide in our body
4)	Digestive	Breaks down food into simpler substances

5. Which statement about the fern and the mushroom is correct?

- 1) Both cannot make their own food.
- 2) Both are non-flowering plants.
- 3) Both reproduce from spores.
- 4) Both only grow on trees.

6. Lily cut the lower part of the stalk of a white flower into 2 equal parts. She placed the parts into containers with different coloured water as shown below.

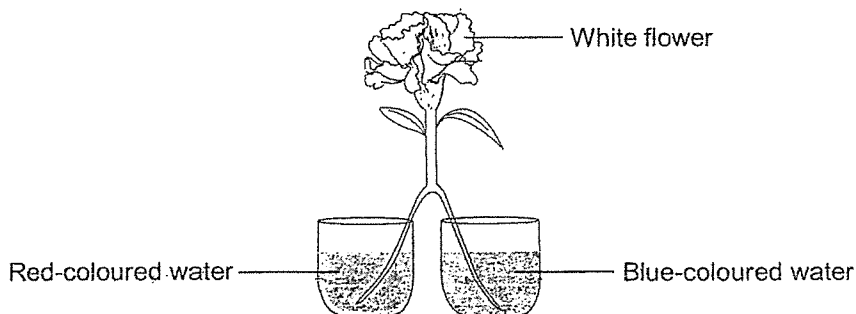

After a short time, she observed that some parts of the flower turned red while some turned blue.

Lily made the following statements based on her observation:

- A: The food made in the flower was red and blue in colour.
- ~~B~~: The stem transported the different coloured water to the flower.
- C: The stem transported food to the flower.

Which statement(s) should be Lily's conclusion based on her observation?

- 1) A only
 - 2) B only
 - 3) A and C only
 - 4) B and C only
7. The chart below shows how substances R and S are transported in the human body.

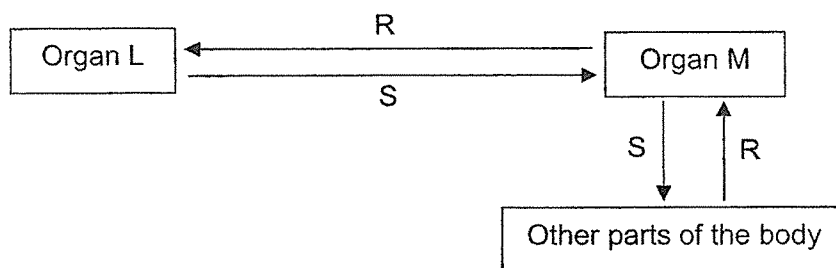

What are organs L and M and substances R and S?

	Organ L	Organ M	Substance R	Substance S
1)	lungs	heart	carbon dioxide	oxygen
2)	heart	lungs	carbon dioxide	oxygen
3)	lungs	stomach	oxygen	carbon dioxide
4)	stomach	heart	oxygen	carbon dioxide

8. Which one of the following graphs shows the breathing rate of a boy who sat for 5 minutes, then ran for some time and finally, sat down to rest again?

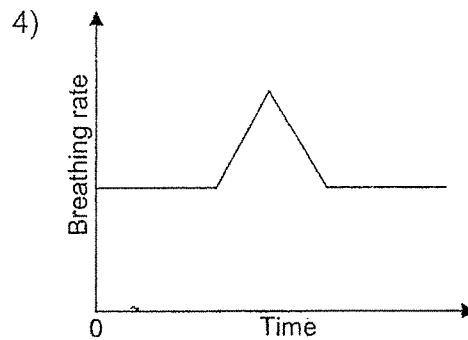
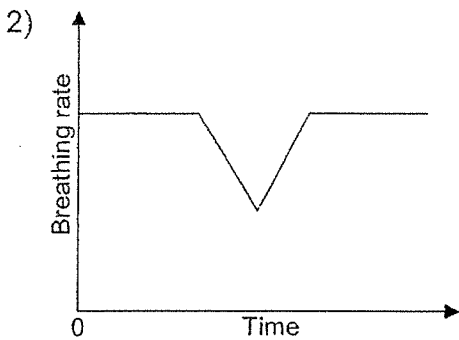
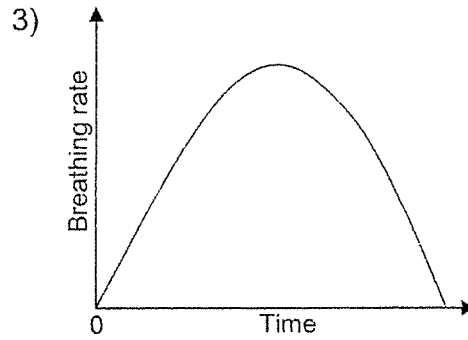
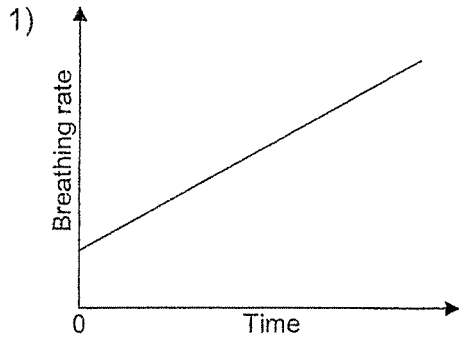

9. The diagram below shows a human digestive system.

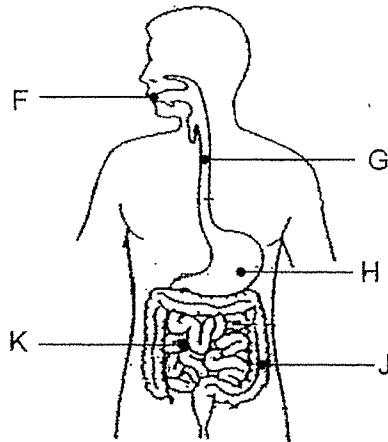

Which of the following organs are able to break down food into simpler substances?

- | | |
|-----------------|--------------------|
| 1) F and G only | 3) F, H and K only |
| 2) G and H only | 4) G, H and K only |

10. Study the plant cell below.

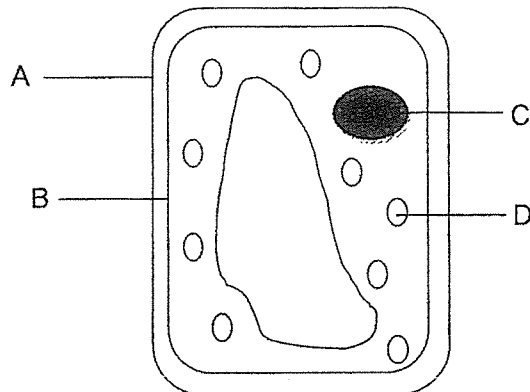

Which parts are also found in an animal cell?

- | | |
|------------|------------|
| 1) A and B | 3) B and C |
| 2) A and D | 4) C and D |

11. The table below shows some information about 3 different cells, A, B and C.

Parts of a cell	Cell A	Cell B	Cell C
Cell wall	No	Yes	Yes
Chloroplast	No	Yes	No
Nucleus	Yes	Yes	Yes

Based on the table above, which of the following statements describe/s cells A, B and C?

- A: Cell A has a fixed shape.
- B: Cell B is able to photosynthesise.
- C: Cell C must be taken from a flower.

- | | |
|-----------------|-----------------|
| 1) B only | 3) A and C only |
| 2) A and B only | 4) B and C only |

12. Study the electrical circuit below. All 4 bulbs are lighted up.

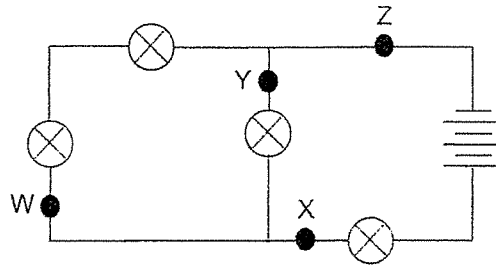

Where can a switch be placed so that when the switch is open, only 3 bulbs remain lit?

- 1) W
- 2) X
- 3) Y
- 4) Z

13. The diagram below shows a circuit tester and a circuit board. The circuit board is connected at 3 points by wires.

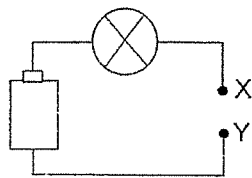

Circuit tester

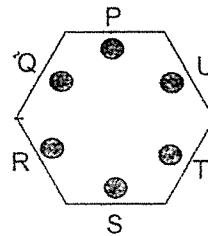

Circuit board

When the 2 points, X and Y of the circuit tester are placed on 2 different points on the board, the results are shown in the table below.

Points connected	Does the bulb light up?
P and R	No
Q and U	Yes
S and U	Yes
R and T	No

Which of the following pairs of points will light up the bulb when connected to the circuit tester?

- 1) P and T
- 2) Q and S
- 3) R and U
- 4) T and U

14. Study the classification chart below.

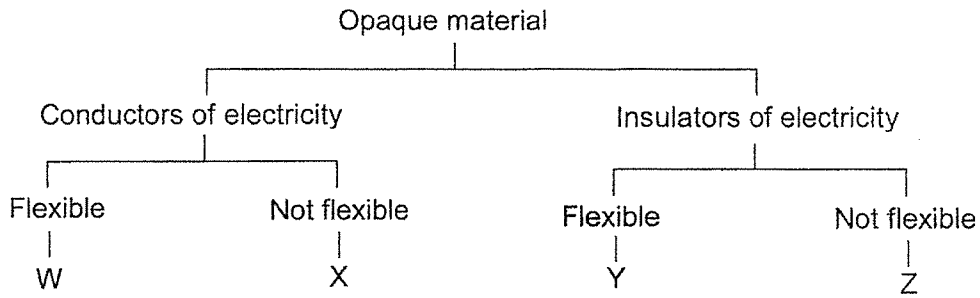

Based on the information given in the chart above, which of the following correctly represent W, X, Y and Z?

	W	X	Y	Z
1)	copper wire	sweater	steel rod	brick
2)	sweater	copper wire	brick	steel rod
3)	copper wire	steel rod	sweater	brick
4)	steel rod	copper wire	brick	sweater

15. The graph below shows the possible relationship between 2 variables in an electrical circuit.

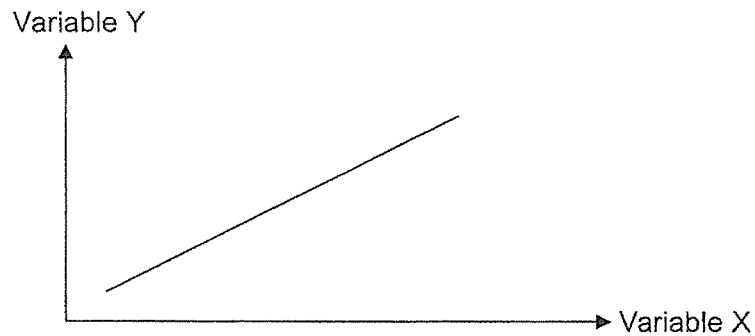

Which of the following could represent both variables X and Y in the graph above?

	Variable X	Variable Y
A	Number of bulbs	Brightness of bulbs
B	Number of batteries	Brightness of bulbs
C	Number of batteries	Number of bulbs

- | | |
|-----------------|-----------------|
| 1) B only | 3) A and B only |
| 2) B and C only | 4) A and C only |

16. Kathy placed objects R and S into a box of iron pins. She then took both objects out of the box. The diagrams below show her observations.

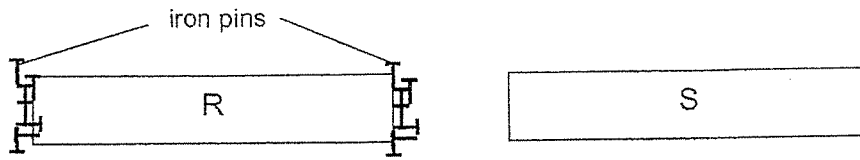

Based on Kathy's observations, which one of the following statement/s is/are definitely true?

- A: Object R is a magnet.
- B: Object R is made of copper.
- C: Object S is made of rubber.

- 1) A only
- 2) B only
- 3) A and B only
- 4) B and C only

17. Steffi arranged 4 bar magnets and placed 2 compasses, A and B as shown below.

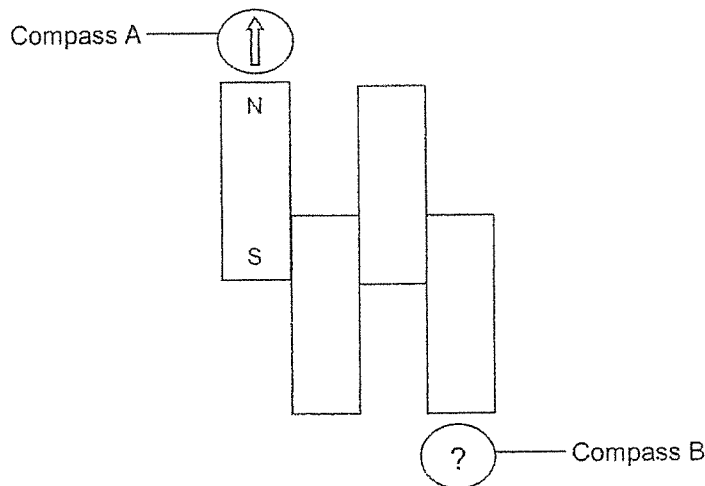

Which of the following is Compass B?

- 1)
- 2)
- 3)
- 4)

18. Pei Hwa placed a mushroom and a plant in 2 similar glass containers as shown below in a sunny place for 5 hours.

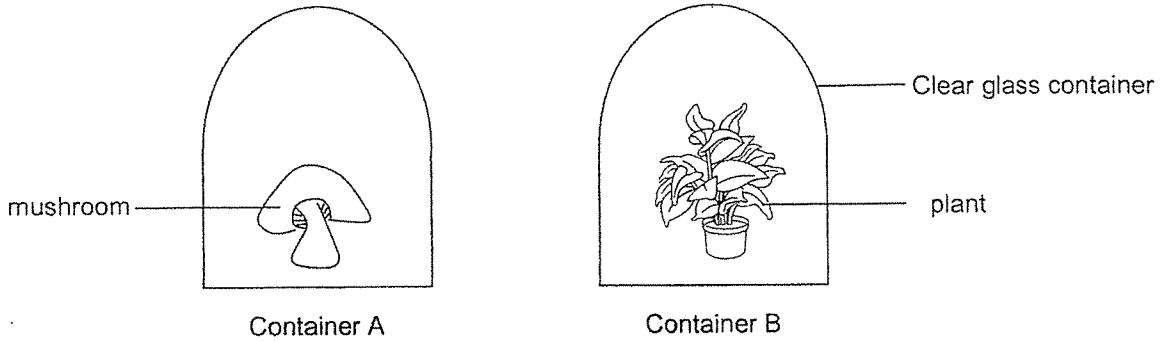

Which of the following correctly shows the amount of carbon dioxide in each container after 5 hours?

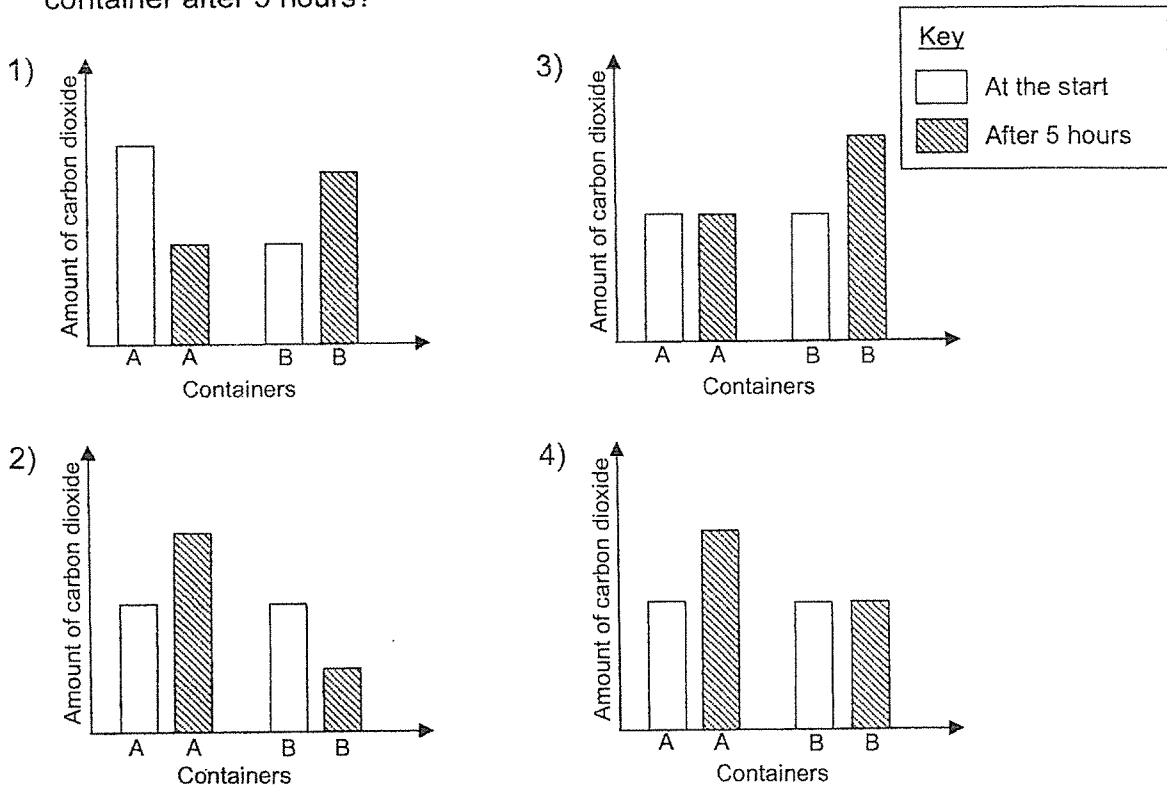

19. The graph below shows the time Insect P spends at different stages of its life cycle.

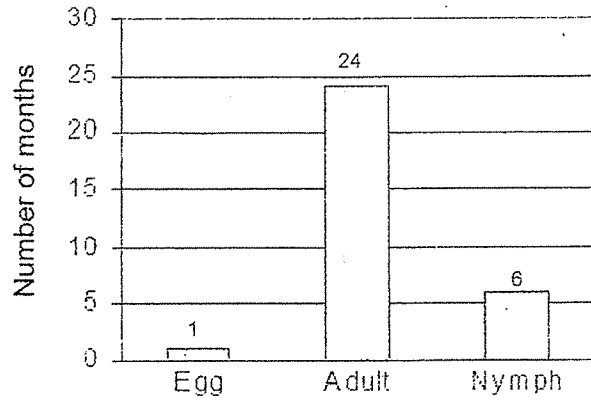

Which of the following statements can be concluded from the graph?

- A: Insect P is a pest at the adult stage.
- B: Insect P undergoes a three-stage life cycle.
- C: The nymph stage is spent in water but the adult stage is spent on land.
- D: It takes 7 months for insect P to become an adult after the egg is laid.









- 1) A and C only
- 2) A and D only

- 3) B and C only
- 4) B and D only

20. Study the information given in the table below.

	Animal A	Animal B
Number of stages in its life cycle	4	3
Does it moult?	Yes	No
Does it lay eggs in water?	Yes	Yes

Which of the following correctly represent animals A and B?

	Animal A	Animal B
1)	 bee	 cockroach
2)	 dragonfly	 frog
3)	 cockroach	 mosquito
4)	 mosquito	 frog

21. Which of the following statements on the reproduction of humans are correct?

- A : Only 1 sperm is needed to fertilise an egg.
- B : The fertilised egg develops in the vagina.
- C : Sperms are produced in the testes.

- 1) A and B only
- 2) A and C only
- 3) B and C only
- 4) A, B and C only

22. Esther set up an experiment as shown below. She poured 100 ml of water into each funnel and left the set-ups for 30 seconds.

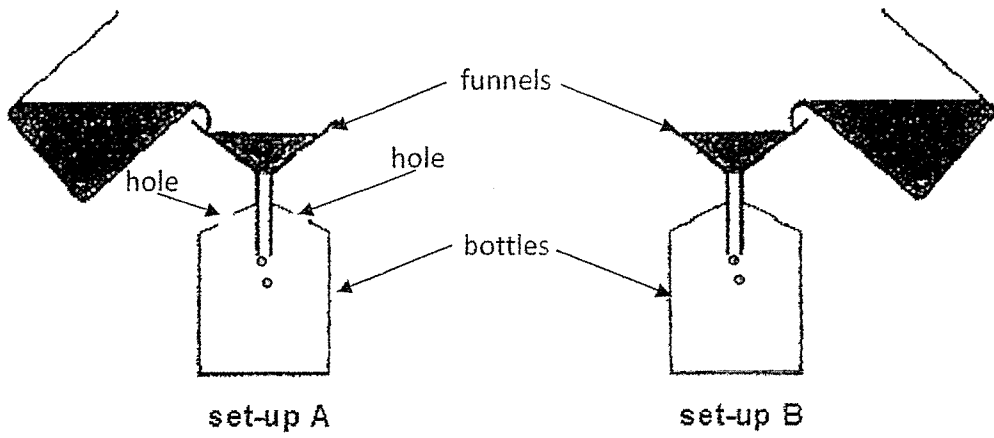

Which of the following readings shows the correct amount of water collected in the bottle of each set-up?

	Bottle A	Bottle B
1)	30 ml	0ml
2)	30 ml	100ml
3)	100ml	30ml
4)	100ml	100ml

23. Tina has 2 materials, F and G. She wants to find out which material will dry faster. Which of the following set-ups will give her a fair comparison?

1) 3)

2) 4)

24. Which of the following graphs shows the temperature of 50 ml of tap water at room temperature being heated continuously for twenty minutes?

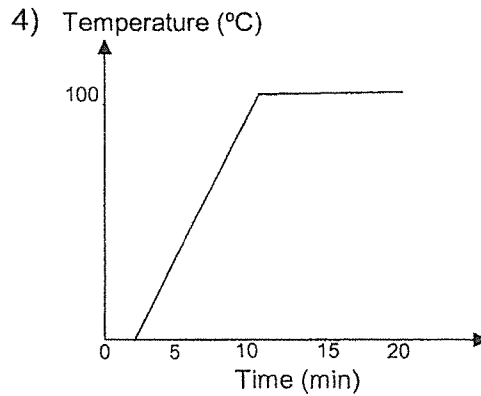
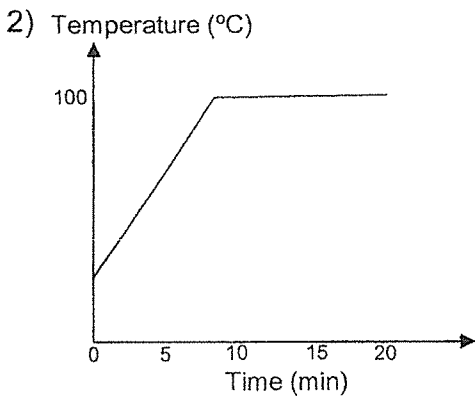
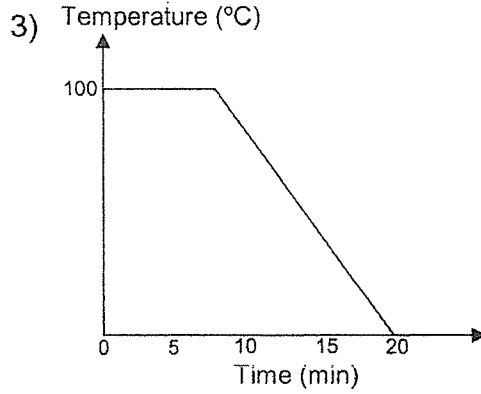
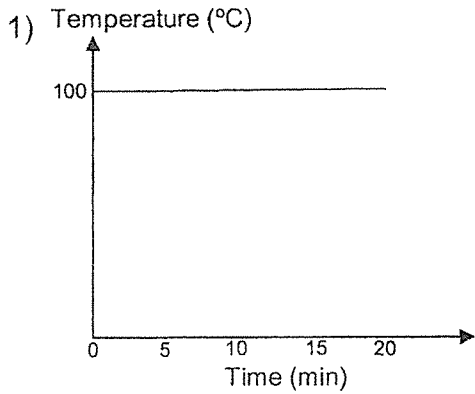

25. The diagram below shows a plastic cube floating in a basin of water.

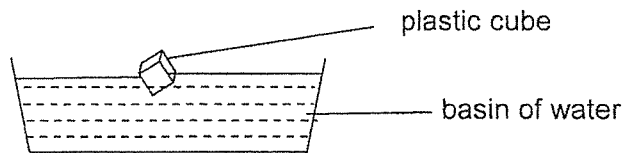

Which diagram shows what happens when an empty glass is inverted over it?

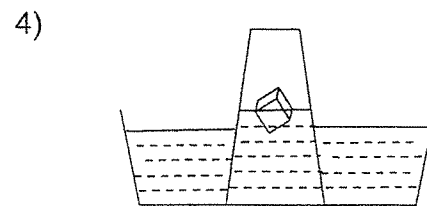
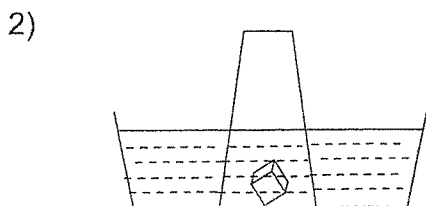
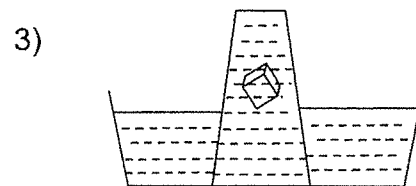
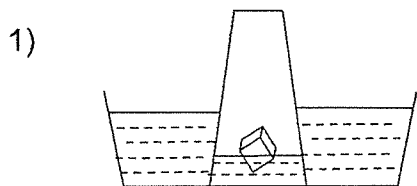

26. Andrew carried out an experiment as shown below.

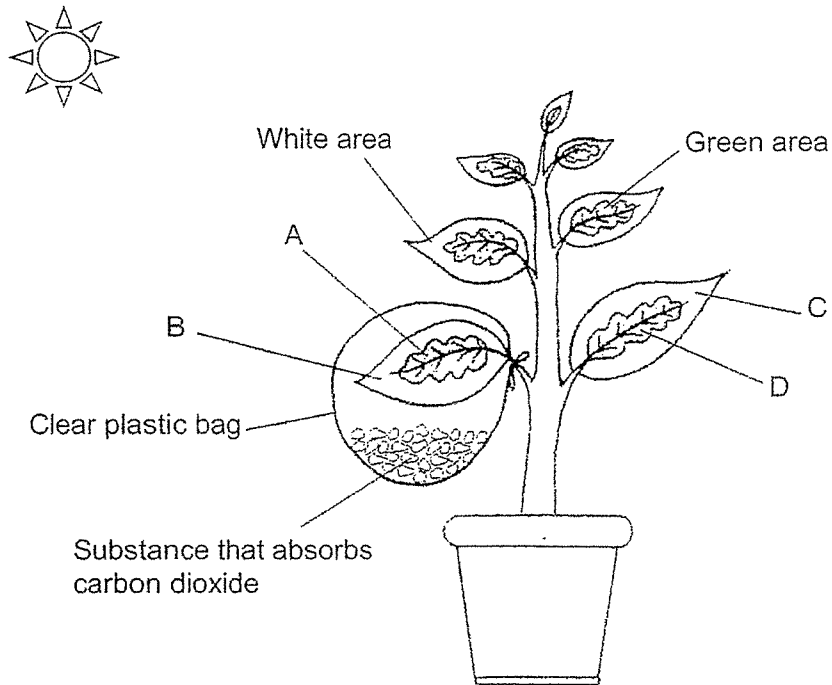

Which 2 areas of the leaves, A, B, C and/or D, should Andrew compare to show that carbon dioxide is needed for photosynthesis?

- 1) A and B
- 2) A and D
- 3) B and C
- 4) C and D

27. Li Ling placed 4 similar pieces of wax on a metal ring as shown below. She heated the ring at Position X.

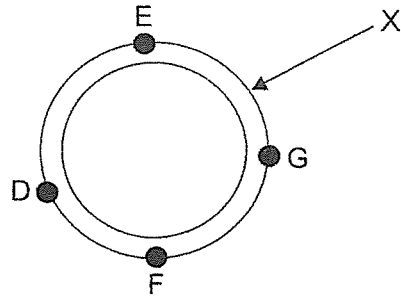

Arrange D, E, F and G in ascending order according to the length of time taken for each wax on the metal ring to melt.

- 1) D, E, F, G
- 2) F, E, D, G
- 3) G, F, E, D
- 4) G, E, F, D

28. Audrey placed 4 objects between a torch and screen as shown below.

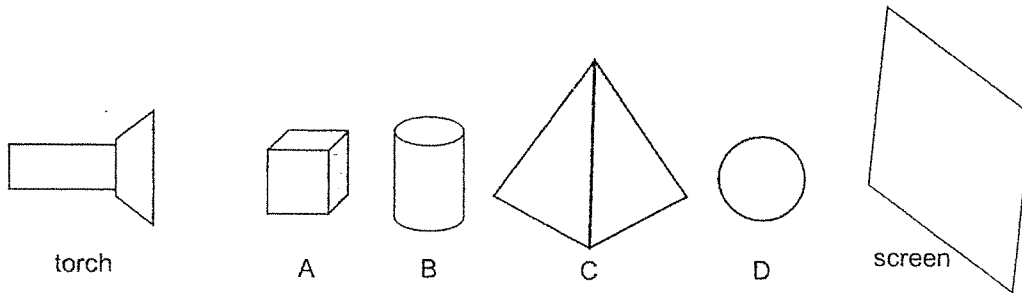

The shadow below was observed on the screen.

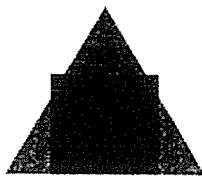

Which of following correctly represents the transparency of all the objects?

	A	B	C	D
1)	Not possible to tell	Transparent	Opaque	Translucent
2)	Opaque	Translucent	Not possible to tell	Transparent
3)	Opaque	Transparent	Translucent	Not possible to tell
4)	Transparent	Not possible to tell	Translucent	Opaque

End of Booklet A

SINGAPORE CHINESE GIRLS' SCHOOL (PRIMARY)

SECOND SEMESTRAL ASSESSMENT 2021

NAME: _____ ()

DATE: 26 October 2021

CLASS: PRIMARY 5 SY

SCIENCE

BOOKLET B

	Total Actual Marks	Total Possible Marks
Booklet A		56
Booklet B		44
Total		100

12 questions

44 marks

Total time for Booklets A & B: 1 h 45 min

DO NOT OPEN THIS BOOKLET UNTIL YOU ARE TOLD TO DO SO.

FOLLOW ALL INSTRUCTIONS CAREFULLY.

Part II (44 marks)

Answer all the following questions.

29. Study the flowchart below carefully.

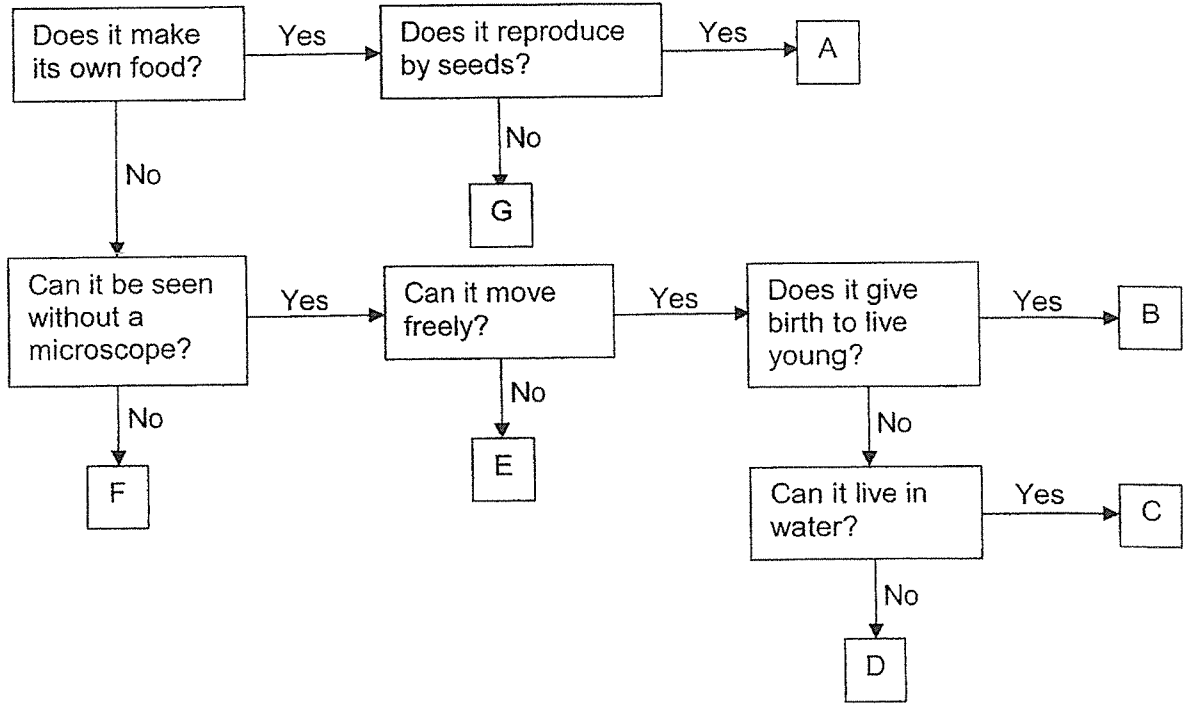

a) Which of the letters (A to G) represent the following organisms? [2]

i)	Angsana tree	
ii)	Horse	
iii)	Bacteria	
iv)	Eagle	

b) Using the information from the flowchart, state a similarity between Organisms A and G. [1]

c) Devi said that Organism B must be a mammal. Explain why this may ^{be} not true. [1]



30. a) The two pie charts below show the composition of inhaled and exhaled air.

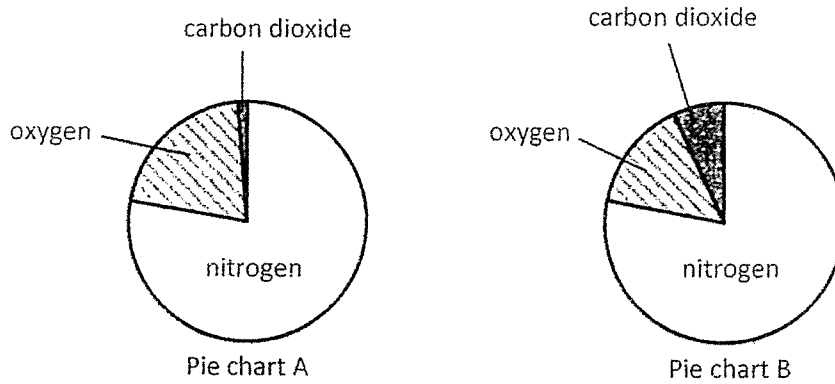

i) Indicate which chart, A or B, represents exhaled air and inhaled air. [1]

Exhaled air: _____ Inhaled air: _____

ii) The pie charts above show that there is no difference in the amounts of nitrogen in the inhaled and exhaled air. Explain. [1]

b) The diagram below shows how blood flows in the human body.

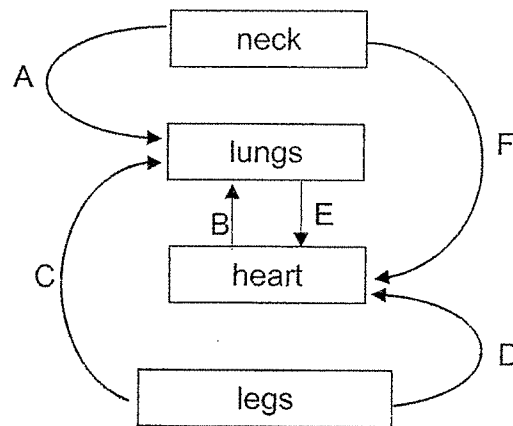

i) Identify the arrow/s which is/are drawn incorrectly. [1]

ii) Which arrow/s, B, E and/or F, contain/s the most oxygen? [1]

31. a) State the 3 substances the leaves of a plant will be able to give out. [1]

b) Sumei placed 3 plants into a beaker each containing 200 cm³ of water as shown below.

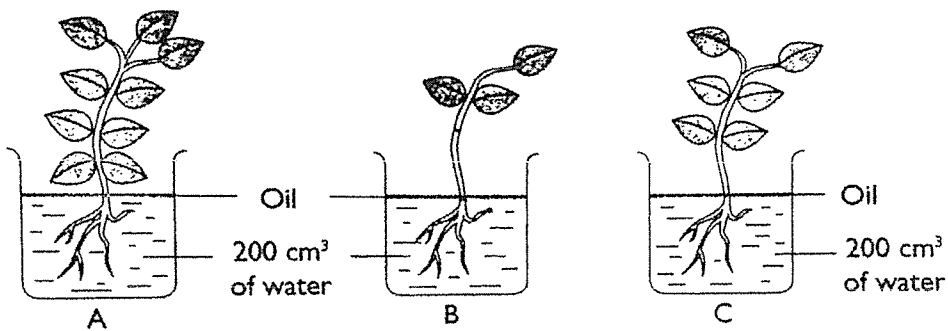

i) Which set-up, A, B or C, would have the least amount of water left at the end of 4 days? [1]

ii) Explain your answer for (a). [2]

iii) How does putting a layer of oil on the water surface ensure that the result is more accurate? [1]

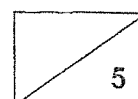

32. Anita wants to make a new magnet by the 'Stroke' method.

- a) She knows that she needs a nail and a magnet.
Name a suitable material for the nail.

[1]

- b) Anita does not know how to 'stroke' the nail so that it becomes a temporary magnet.

Put a tick (✓) in the box for the correct way to 'stroke' a nail.

[1]

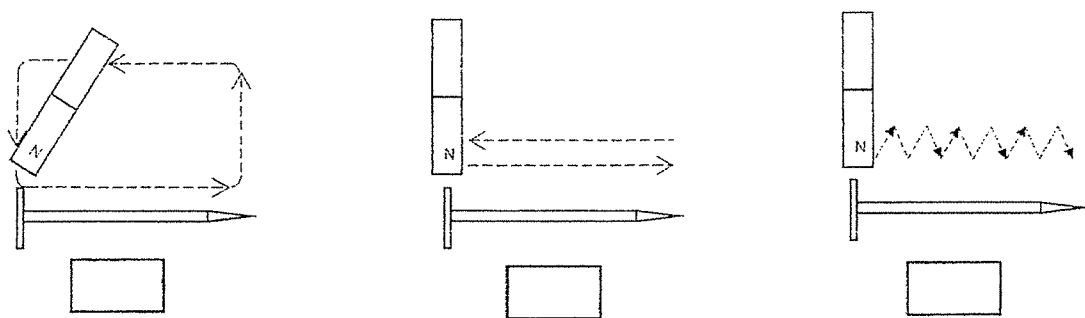

- c) After stroking with the magnet on the nail, Anita wants to find out if it has really become a new magnet. She placed a magnet near the nail as shown in the diagram below. The nail was attracted to the magnet. She concluded that the nail has become a new magnet.



- i) Explain why her conclusion may be wrong.

[1]

- ii) To definitely conclude that it is magnet, suggest what Anita can do.

[1]



33. Penny set up an electrical circuit as shown below to find out the electrical conductivity of 3 materials, X, Y and Z.

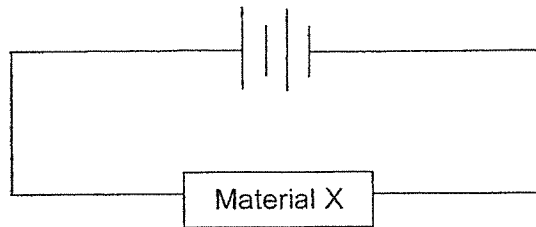

- a) Unfortunately, Penny was not able to observe the results immediately although the batteries are working. There was something missing in the above circuit.

Using only circuit symbols, draw the improved electrical circuit that will enable Penny to test out the aim of her experiment. [2]

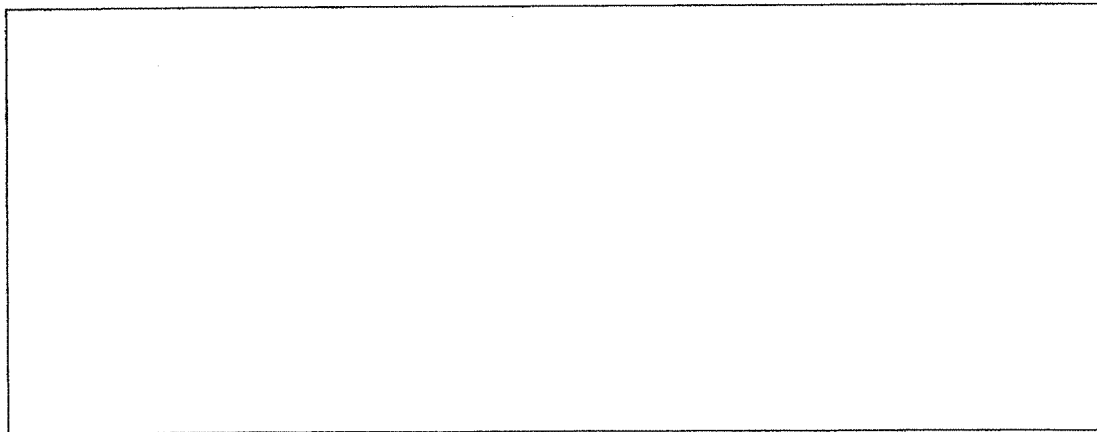

- b) The wire that Penny used for her electric circuit was covered with rubber casing. She will not be electrocuted while using this wire. Explain clearly why rubber is used. [1]

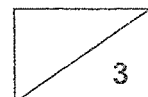

34. a) State 2 substances produced during photosynthesis.

[1]

b) Xiao Ting carried out the experiment as shown below.

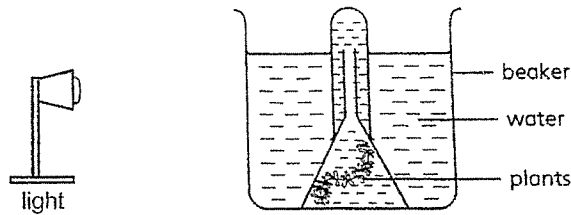

The results of her experiment are recorded in the table below.

Distance between light source and plant (cm)	Number of bubbles produced per minute
10	18
20	17
30	16
40	13
50	10
60	6
70	2
80	2

i) Based on the results above, how does the distance between the light source and plant affect the rate of photosynthesis? Explain your answer. [2]

ii) Explain why the number of bubbles produced per minute remained the same when the light source was 70 cm to 80 cm away from the plant. [1]

iii) Xiao Ting added a water snail in the beaker. What will happen to the number of bubbles produced per minute? **Circle** your answer below. [1]

Increase

Remain the same

Decrease

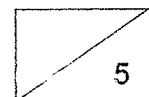

35. Hanis poured 600 ml of water at 100°C into a metal container and sealed it. The container was then placed in a paper box filled with cotton wool.

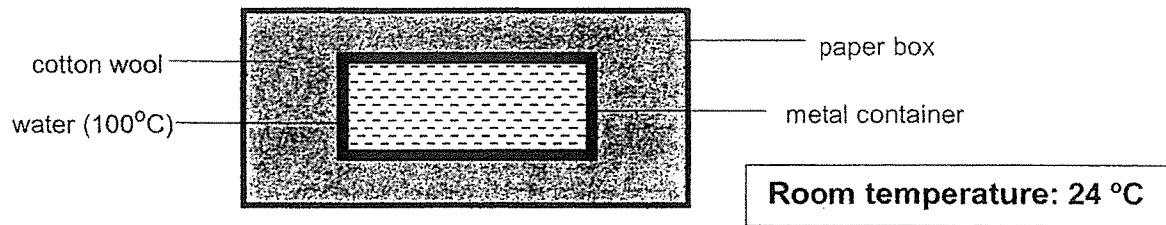

Pei Hwa recorded the temperatures of the metal container and hot water at regular intervals. The graph below shows the changes in the temperatures of the metal container and hot water over time.

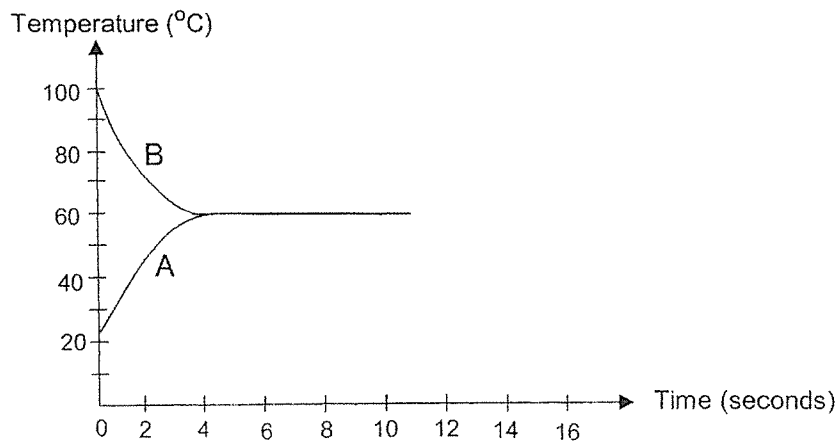

- a) Which line, A or B, shows the heat changes in the metal container? [1]

- b) Based on the results of the experiment, what can you conclude about heat conduction? [1]

- c) What is the temperature of the paper box at the 10th second? [1]

- d) The temperature of the hot water remained at 60°C for several minutes. Explain why. [1]

36. Cameron is able to see the apple on the table.

- a) **Draw** the path of light which allows Cameron to see the apple.
(Use a ruler to draw lines with arrows.)

[2]

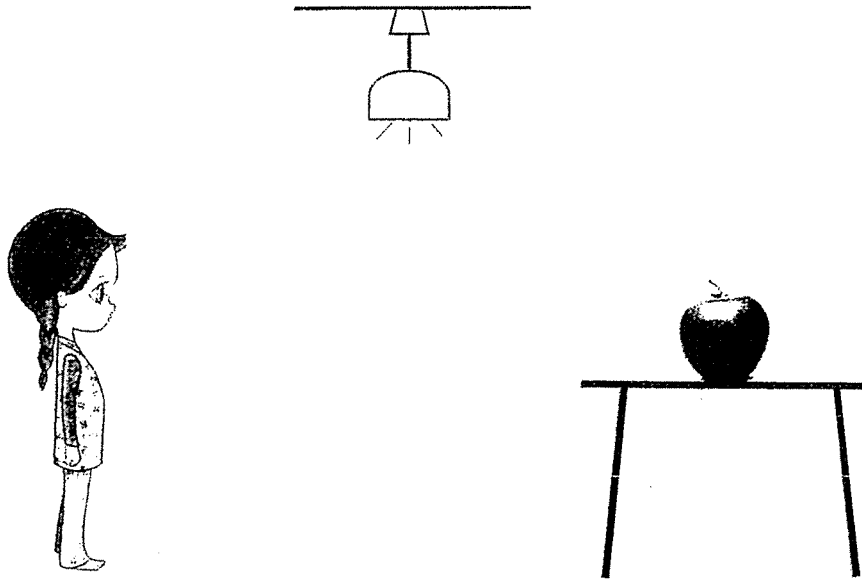

- b) Will Cameron see the apple in a dark room? Explain your answer.

[1]

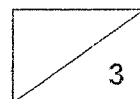

37. The graph below shows the relationship between the volume and mass of Substance S in a 1000 cm³ container.

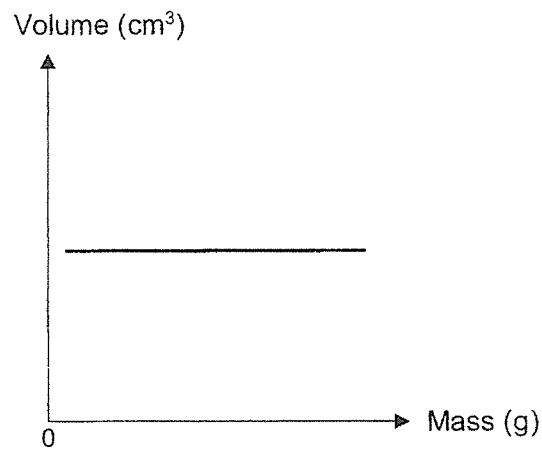

a) State the relationship between the volume of Substance S and its mass. [1]

b) What is the state of Substance S? [1]

c) Tick (✓) the correct graph which shows the relationship between the volume and mass of water. [1]

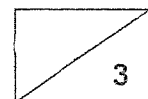
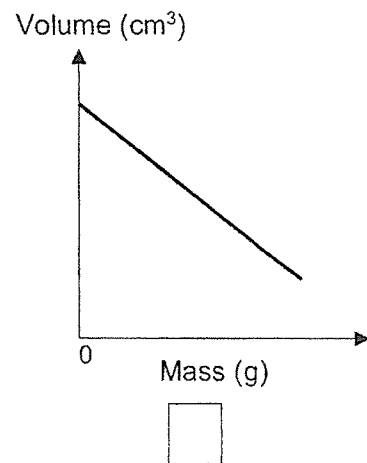
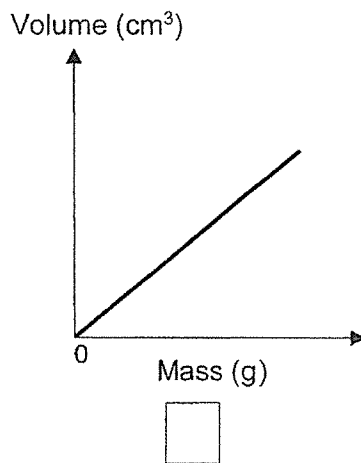
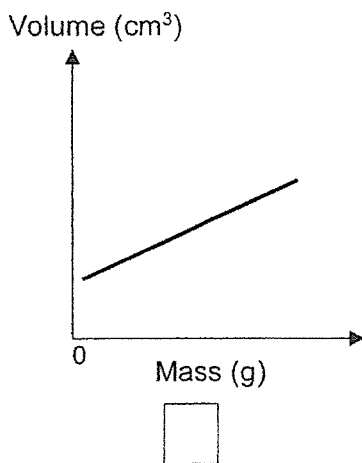

38. Study the life cycle of Animals P and Q below.

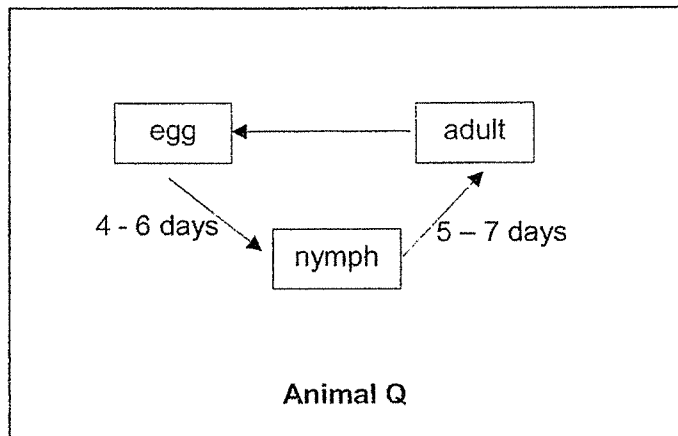
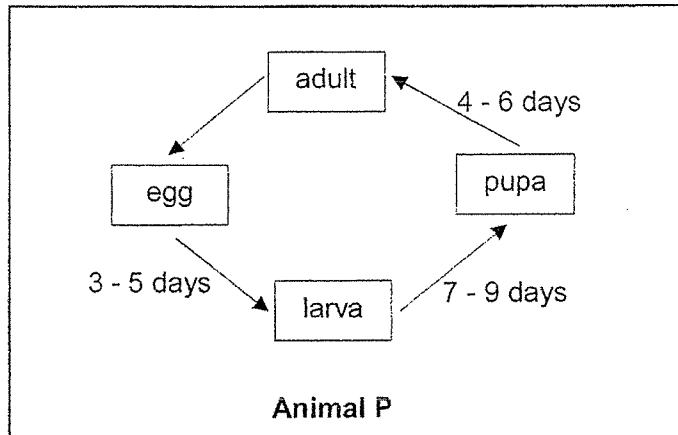

Read the following statements about Animals P and Q.
Tick 'T' for 'True' statement/s and 'F' for 'False' statement/s.

[2]

Statements	T	F
a) The young of both animals P and Q moult.		
b) The young of animal Q resembles its adult but the young of animal P does not		
c) Animal P takes at least 11 days to become an adult after hatching.		
d) The nymph and larva stages are the least active stage.		

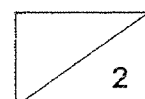

39. Adrianna wanted to find out if Containers A, B and C, which are of different shapes, will affect the rate of evaporation. She was given the following apparatus to conduct an experiment.

- Containers A, B and C (different shapes)
- A measuring cylinder
- 1000 ml of water

a) The following are the steps to carrying out the above experiment. However, they are not arranged in sequence.

Write 1, 2, 3 and 4 to show the correct sequence of the steps to carrying out the experiment. [2]

Steps	Description
	Conduct the experiment over 3 days.
	Pour an equal volume of water into Containers A, B and C.
	Measure the amount of water left in each container using the measuring cylinder.
	Place Containers A, B and C on a table in the Science room.

b) Placing Containers A, B and C at the same location makes the experiment a fair one.

List 2 variables which are kept the same when Containers A, B and C are placed at the same location. [1]

Variable 1	
Variable 2	

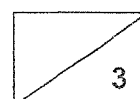

40. Ellie set-up an experiment as shown below.

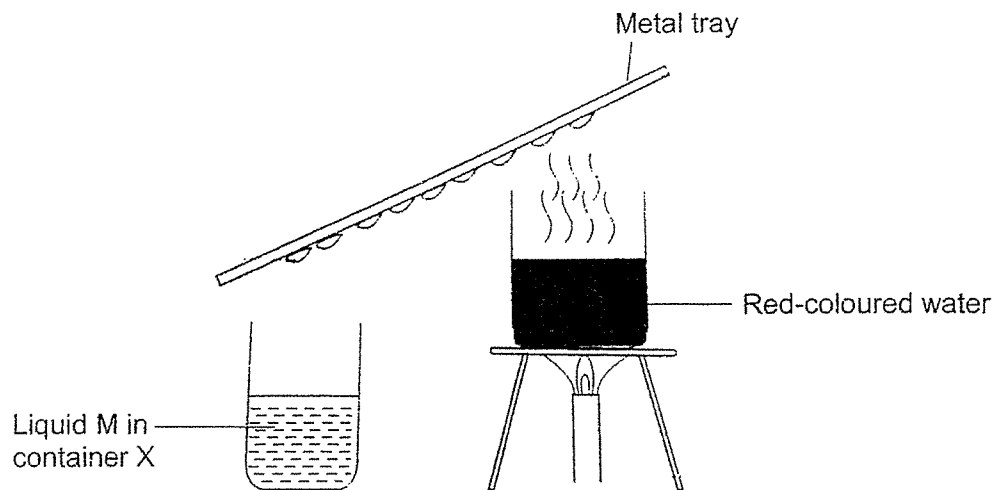

a) What is the colour of liquid M? [1]

b) Explain how liquid M is collected in container X from boiling the red-coloured water. [2]

c) After some time, there were no more water droplets forming on the tray. Explain why. [1]

ANSWER KEY

YEAR : 2021
LEVEL : PRIMARY 5
SCHOOL : SCGS
SUBJECT : SCIENCE
TERM : SA2

BOOKLET A

Q1	1	Q2	3	Q3	4	Q4	3	Q5	3
Q6	2	Q7	1	Q8	4	Q9	3	Q10	3
Q11	1	Q12	3	Q13	2	Q14	3	Q15	1
Q16	1	Q17	1	Q18	2	Q19	4	Q20	4
Q21	2	Q22	3	Q23	4	Q24	2	Q25	1
Q26	2	Q27	4	Q28	3				

NAME: _____ () Class: _____

SCGS 2021 SA2 PRIMARY 5 SCIENCE

Booklet B

No.	Suggested Answer
29a	A, B, F, D
b	Both are plants make their own food.
c	There are other <u>animals that also give birth</u> such as <u>some fish/ reptiles</u> OR Some mammals such as platypus do not give birth to live young
30a	i) Exhaled air – B Inhaled air - A ii) Nitrogen is not absorbed/ produced by our body/ our lungs
30b	i) A, C (ii) E
31a	oxygen, carbon dioxide and water/ water vapour
31b	i) Set-up A ii) <u>A has the most number of leaves so it takes in the most amount of water through its roots and lost/ give out/ evaporate the most amount of water/water vapour through its leaves.</u> <i>Correct comparison and function of relevant plant parts must be shown.</i> iii) <u>Oil prevents water in beaker from evaporating</u> so the <u>decrease in water level/ decrease in volume of water left</u> is due <u>only</u> to the roots absorbing the water and the loss of water through the leaves.
32a	Iron / Steel
32b	Tick the box on the left
32c	i) The nail is a <u>magnetic material</u> and can be attracted to a magnet. OR No repulsion is seen/ shown, so the nail may just be a magnetic material but not a magnet. ii) She needs to turn the magnet so that it's <u>N-pole</u> faces the nail. <u>If they repel each other</u> , the nail is a magnet. OR She needs to <u>turn the nail so that the flat end faces the magnet</u> . <u>If they repel each other</u> , the nail is a magnet. <i>Must describe how the magnet or the nail is turned and the test for checking the nail is a magnet..</i>
33a	
33b	Rubber is a <u>non-conductor/insulator of electricity</u> / does not conduct electricity.
34a	oxygen and glucose/sugar/food
34b	i) When the distance between the light source and the plant decreases , the rate of photosynthesis increases because when the light is nearer to the plant, the plant has <u>more light to photosynthesise more/ faster to produce more oxygen</u> (in the form of bubbles as shown in the table/ results). ii) The amount of light reaching the plant was not <u>significantly different/ different enough</u> (to cause a significant difference in the results).

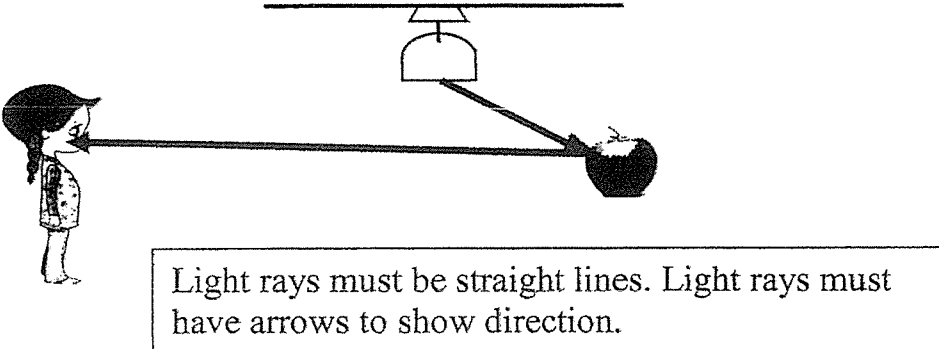
	iii) Increase (Reason: Snail will provide more carbon dioxide more photosynthesis)		
35a	A		
35b	Heat travels from a hotter to cooler region/place (until the same temperature is reached). <i>Direction of heat transfer must be shown.</i>		
35c	24°C - 60 °C (inclusive) Must show correct unit		
35d	Cotton/air in the cotton wool is a poor conductor of heat . Thus, <u>heat travels/ is conducted slowly from the hot water/ metal container to the surrounding air.</u> < Must indicate heat transfer is slow & show direction of transfer >		
36a			
36b	No. Apple is not a source of light. OR No. There is no light in the room.		
37a	When the mass of S increased, its volume remained the same. <i>Note – Mass is the independent / changed variable in the graph.</i>		
37b	Gas		
37c	Tick the graph in the middle.		
38	Statements	T	F
	a) The young of both animals P and Q moult.	✓	
	b) The young of animal Q resembles its adult but the young of animal P does not.	✓	
	c) Animal P takes at least 11 days to become an adult after hatching.	✓	
	d) The nymph and larva stages are the least active stage.		✓
39a	3, 1, 4, 2 or 3, 2, 4, 1		
39b	Any 2 of the following: <ul style="list-style-type: none"> - Wind speed/ presence of wind in the surroundings - Temperature of surroundings/ air - Humidity/ Amount of water vapour in the air <i>Note – The variable must be affected by the location</i>		
40a	Colourless , no colour <i>Note that 'transparent' is not a colour.</i>		
40b	Steam from the boiling red-coloured water/ Warmer water vapour that evaporated from the hot red-coloured water lost heat to the cool/ cooler (underside of the) metal tray and condensed into water droplets. The water droplets slid/ dripped down into the container.		
40c	The tray has become too hot (and water vapour can no longer lose heat to condense on it).		