



RED SWASTIKA SCHOOL

SCIENCE 2021 SEMESTRAL EXAMINATION PRIMARY 5

Name : _____ ()

Class : Primary 5/ _____

Date : 2 November 2021

BOOKLET A

Total time for Booklets A & B: 1h 45 min

Booklet A: 25 questions (50 marks)

Note:

1. Do not open the booklet until you are told to do so.
2. Read carefully the instructions given at the beginning of each part of the booklet.
3. Do not waste time. If the question is too difficult for you, go on to the next question.
4. Check your answers thoroughly and make sure you attempt every question.
5. In this booklet, you should have the following:
 - a. Page 1 to Page 17
 - b. Questions 1 to 25

For Questions 1 to 25, choose the most suitable answer and shade its number in the OAS provided.

1. Which of the following characteristics can be used to differentiate between insects and birds?
- (1) number of legs
 - (2) number of feelers
 - (3) presence of wings
 - (4) the way they move

2. The characteristics of two organisms are shown below.

Characteristics	Organism	
	X	Y
Makes its own food	No	Yes
Produces spores	Yes	Yes

What could organisms X and Y be?

	X	Y
(1)	rose plant	mushroom
(2)	mushroom	fern
(3)	fern	rose plant
(4)	fern	mushroom

3. Study the chart below.

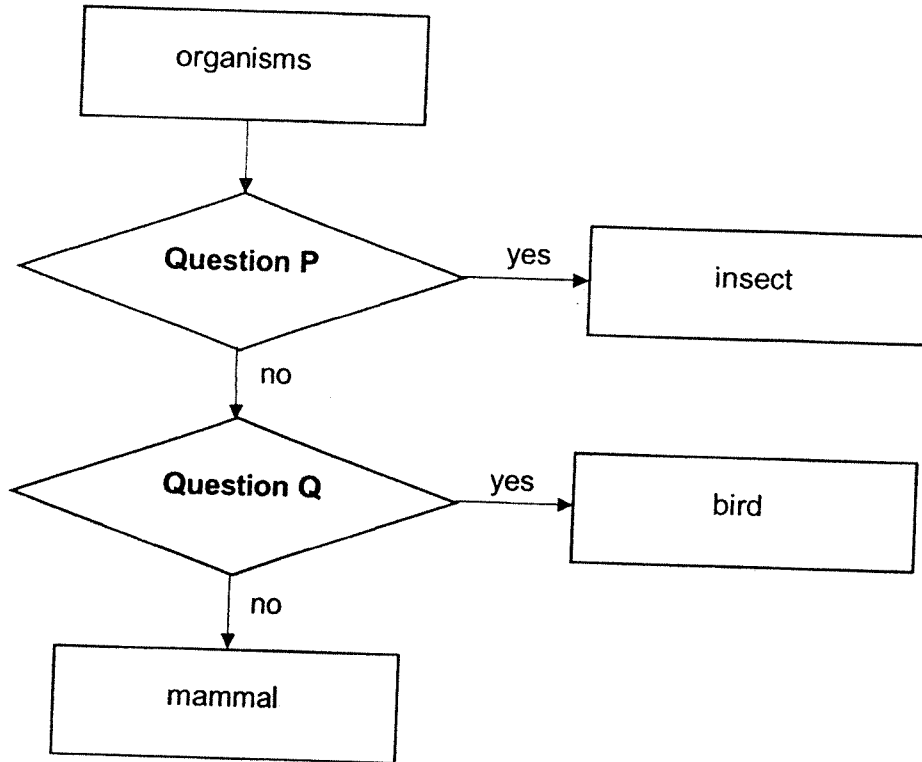

Which of the following is correct?

	Question P	Question Q
(1)	Does it have fur?	Does it have a beak?
(2)	Does it have wings?	Does it have fur?
(3)	Does it have hard body covering?	Does it give birth to young?
(4)	Does it have six legs?	Does it have feathers?

4. The diagram below shows how blood flows in some parts of the human body.

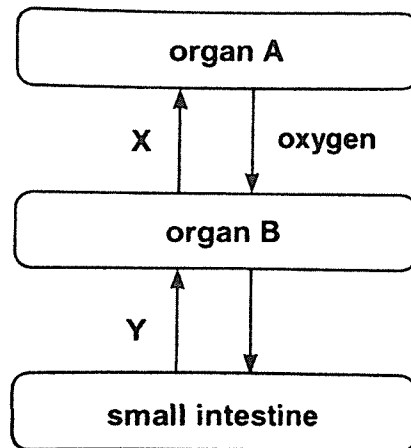

Which of the following is true?

	Organ A	Organ B	Blood at Y
(1)	lungs	heart	contains less digested food than the blood at X
(2)	heart	lungs	contains less digested food than the blood at X
(3)	lungs	heart	contains more digested food than the blood at X
(4)	heart	lungs	contains more digested food than the blood at X

5. Noel prepared a set-up as shown in the diagram below.

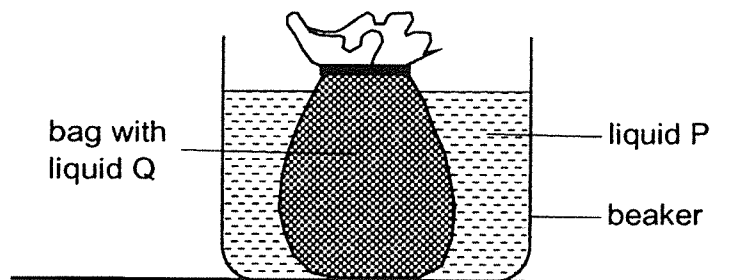

He placed a tightly sealed bag containing liquid Q into a beaker containing liquid P. After some time, he observed that some liquid P was found in the bag.

Based on his observation, which part of the plant cell has a similar function as the bag in the set-up shown above?

- (1) cell wall
- (2) cytoplasm
- (3) chloroplast
- (4) cell membrane

6. The following four pupils were having a discussion about the systems in living things.

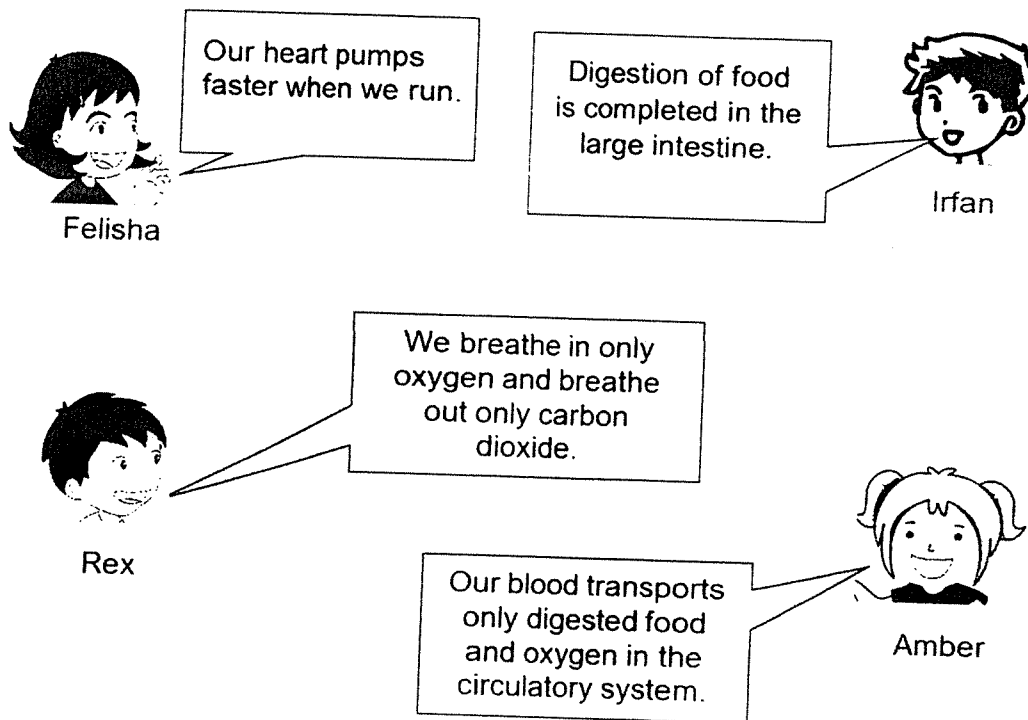

Which pupils made **incorrect** statements?

- (1) Amber and Rex only
- (2) Amber and Irfan only
- (3) Felisha and Irfan only
- (4) Amber, Rex and Irfan only

7. An outer ring of the stem between positions X and Y of a plant is removed. The tubes which carry food between positions X and Y are removed while the tubes which carry water remain in the stem.

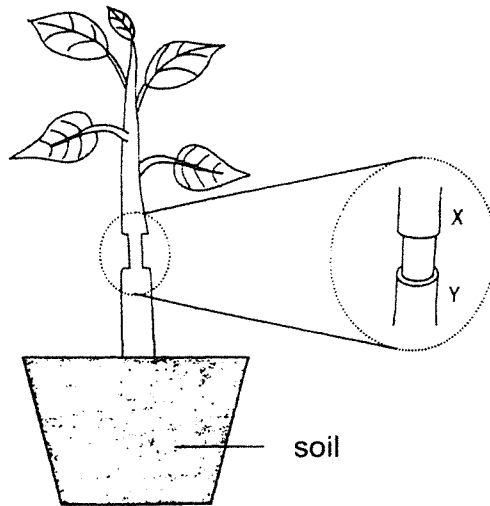

After some time, which one of the following diagrams represents the appearance of the stem?

- (1) (2)
- (3) (4)

8. Natalie conducted an experiment using the following set-ups.

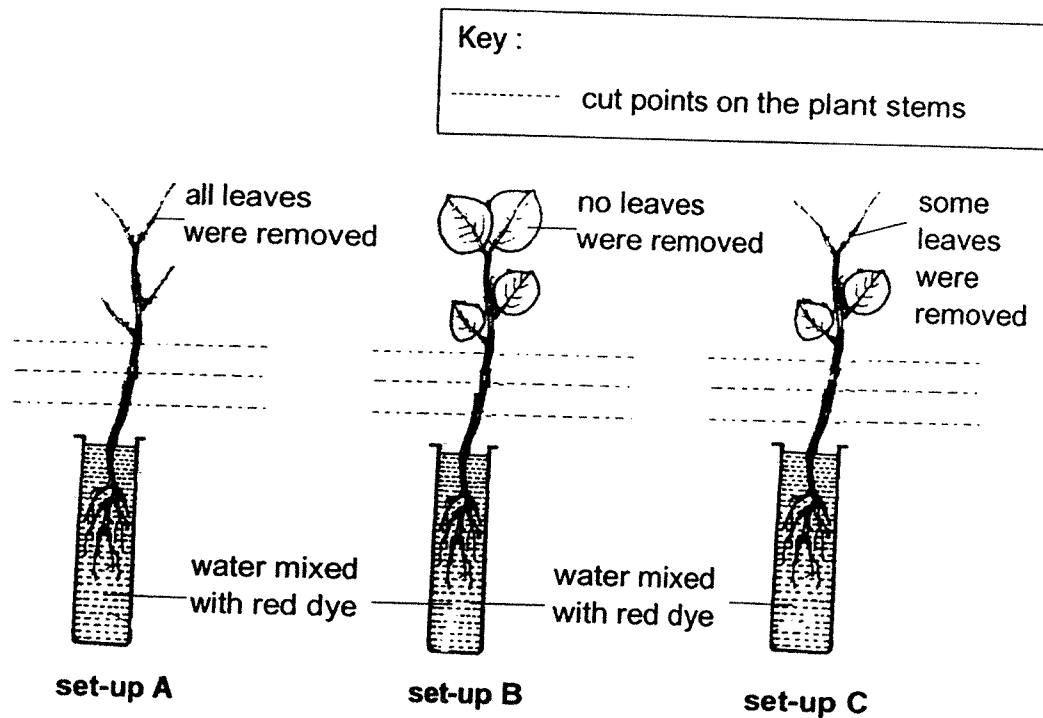

After a day, she made three cut points on the stem of each plant as shown by the dotted lines above and she observed for the presence of water mixed with red dye on the cut surfaces.

Which of the following is likely to be the aim of her experiment?

She wanted to find out if the _____.

- (1) stem transports water from the roots to the leaves
- (2) size of leaves affects the ability of a plant to make food
- (3) number of leaves of a plant affects how quickly water travels up the stem
- (4) presence of roots of a plant affects the rate at which a plant absorbs water

9. Siti made the following statements about a plant.

- A: The anther produces pollen grains.
- B: The ovary of the flower develops into seeds.
- C: The flower appears before the fruit.
- D: The flower has to be germinated to become a fruit.

Which of these statements are true?

- (1) A and B only
- (2) A and C only
- (3) B and C only
- (4) C and D only

10 Seeds X, Y and Z from a plant are placed under the conditions as shown.

seed	conditions			
	water	air	light	temperature (°C)
X	✓	✓	X	30
Y	✓	✓	✓	30
Z	X	✓	✓	5

Which seed(s) can germinate?

- (1) X only
- (2) Y only
- (3) X and Y only
- (4) Y and Z only x

11. Alice wanted to find out which parts of the flower were necessary to form a fruit. She removed two parts of the flower before pollination could occur.

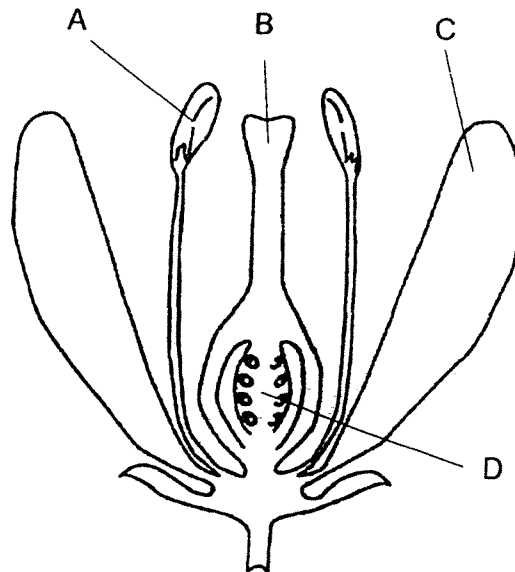

After some time, the flower became a fruit. Which two parts of the flower had been removed?

- (1) A and C only
- (2) A and D only
- (3) B and C only
- (4) B and D only

12. The diagram below shows three types of plants growing on parts of an island.

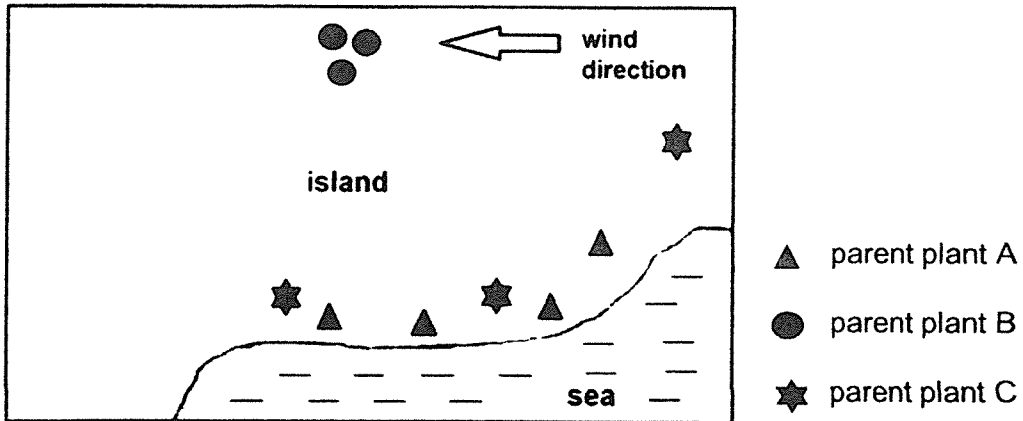

After two years, the plants were found growing on different parts of the island as shown in the diagram below.

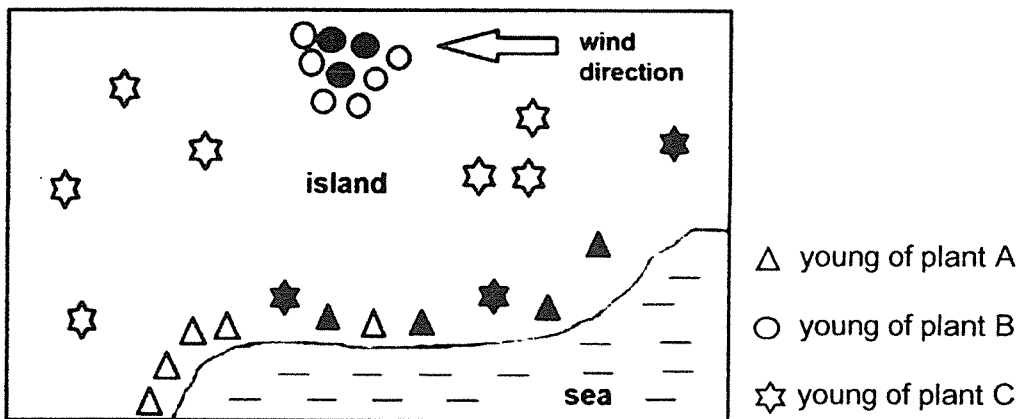

Which of the following correctly describes the characteristics of the fruit of each type of plant?

	▲	●	★
(1)	fibrous husk	have hooks	dry and light
(2)	fibrous husk	pod-like fruit	dry and light
(3)	dry and light	fibrous husk	pod-like fruit
(4)	have hooks	dry and light	fibrous husk

13. Study the electrical circuit below.

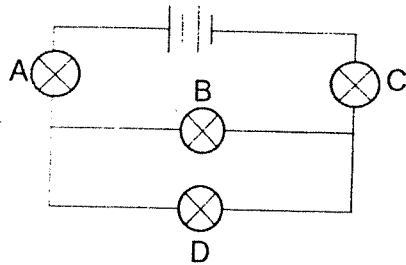

Which of the following statements is correct?

- (1) If bulb A fuses, only bulb C will remain lit.
- (2) If bulb B fuses, only bulb D will remain lit.
- (3) If bulb D fuses, only bulb A and C will remain lit.
- (4) If bulb C fuses, all the other bulbs will not light up.

14. All the circuits below have identical batteries and bulbs which are in good working condition.

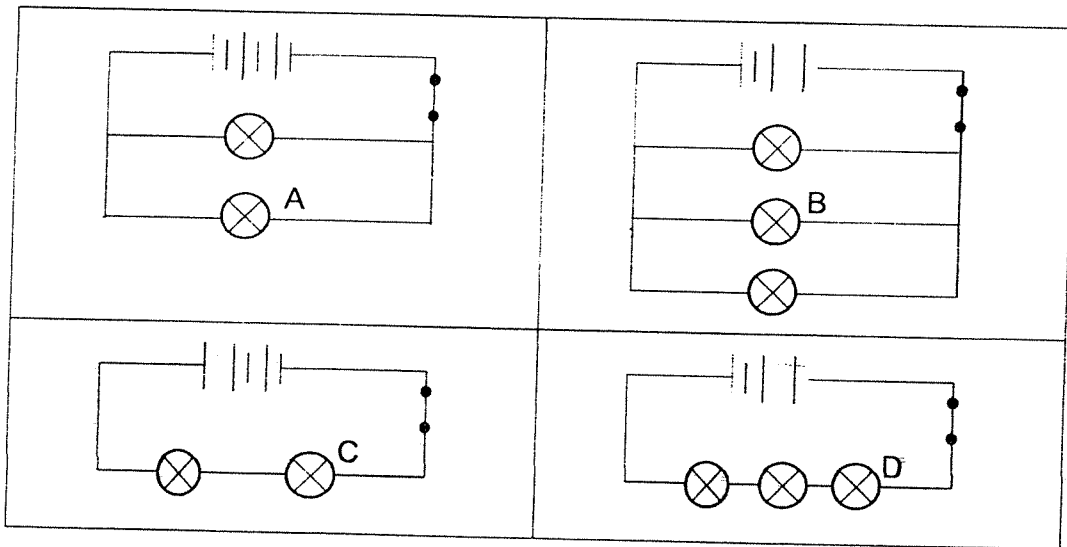

Which bulb(s) would be the brightest?

- (1) A only
- (2) C only
- (3) A and B only
- (4) B and D only

15. Wendy set up a circuit as shown.

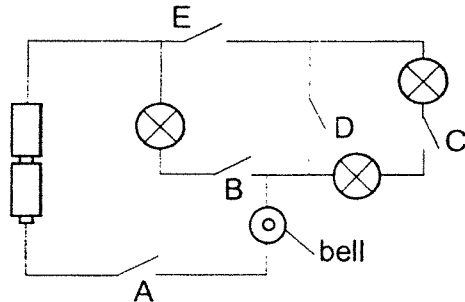

All three bulbs were unlit and the bell rang when some switches were closed. Which switches should she close?

- (1) A, B and E only
- (2) B, D and E only
- (3) A, C and E only
- (4) A, D and E only

16. The diagram below shows a circuit tester and a circuit board. The circuit board is connected to two points by wires.

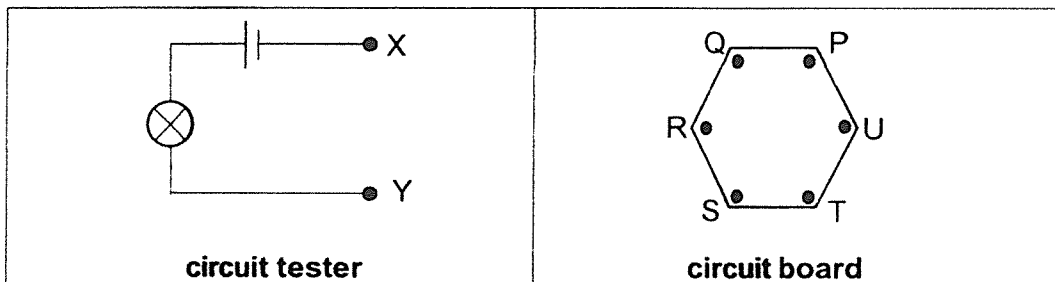

When the two points, X and Y, of the circuit tester are placed on two different points on the circuit board, the results are shown in the table below.

Points connected	Does the bulb light up?
P and R	Yes
Q and U	No
S and U	No
R and T	Yes

Which of the following pairs of points will light up the bulb when connected to the circuit tester?

- (1) P and T
- (2) Q and S
- (3) R and U
- (4) T and U

17. Which one of the following best describes matter?

- (1) Matter has mass only.
- (2) Matter is a non-living thing.
- (3) Matter occupies space only.
- (4) Matter can be in different states.

18. The diagram below represents a water cycle.

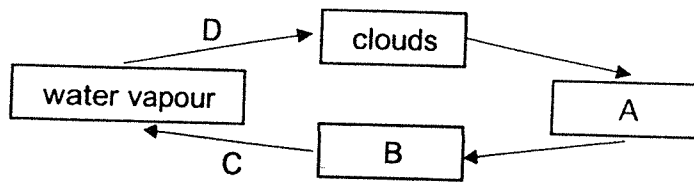

What do A, B, C and D represent?

	A	B	C	D
(1)	rain	seawater	condensation	evaporation
(2)	seawater	rain	condensation	evaporation
(3)	rain	seawater	evaporation	condensation
(4)	seawater	rain	evaporation	condensation

19. A block of melting ice is placed in a beaker as shown in the diagram below.

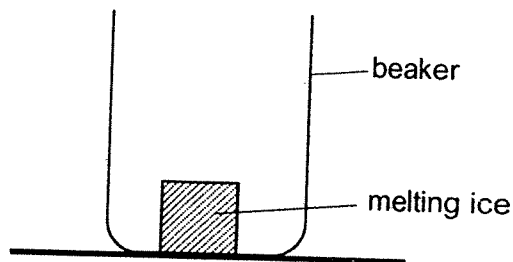

What will happen to the temperature of the air in the beaker and the melting ice during the process of melting?

	Temperature of air in the beaker	Temperature of melting ice
(1)	remains the same	increase
(2)	increases	remains the same
(3)	decreases	remains the same
(4)	decreases	decreases

20. Alice wanted to find out how the exposed surface area of a handkerchief affects the time taken for it to dry. She hung three identical handkerchiefs, A, B and C, containing the same amount of water out in the sun. Each handkerchief was folded to expose a different amount of surface area. The three handkerchiefs were weighed after half an hour. Her results are shown in the graph below.

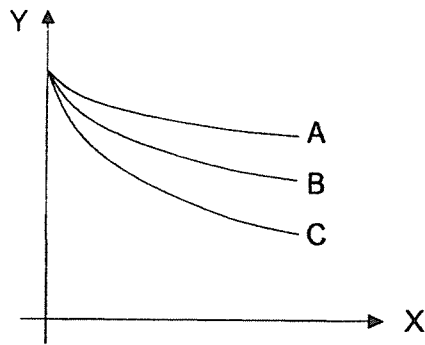

Which one of the following gives the correct labels for X and Y of the graph plotted by Alice?

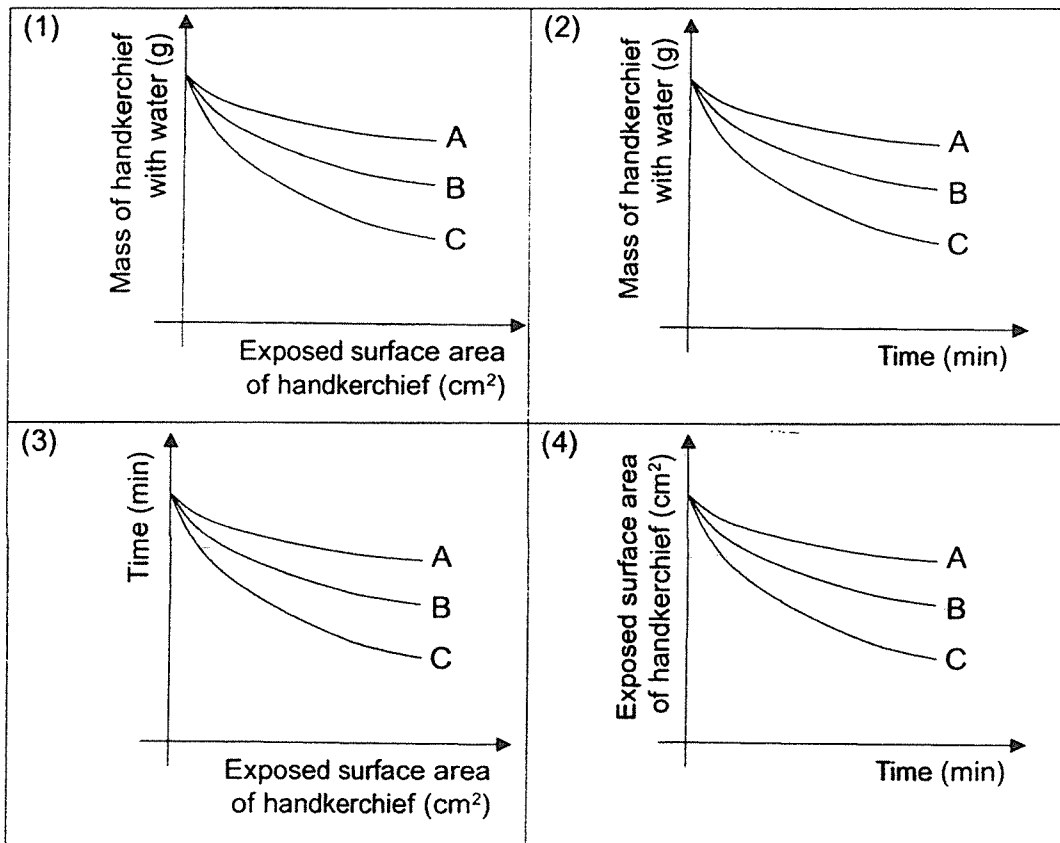

21. Ali touched the glass of cold water as shown. His hand felt cold.

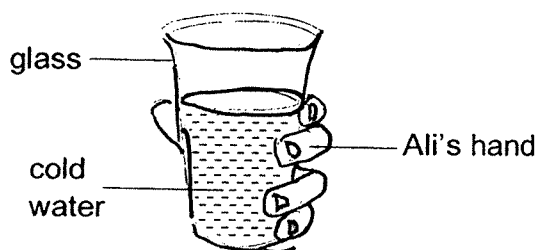

Which of the following explains why his hand felt cold?

- (1) There is heat loss from his hand to the glass.
- (2) There is heat gain from his hand to the glass.
- (3) There is heat loss from the cold water to his hand.
- (4) There is heat gain from the cold water to his hand.

22. Study the information below.

Substance	State of substance at		
	60°C	100°C	150°C
X	solid	solid	solid
Y	solid	solid	liquid
Z	liquid	liquid	gas

Which of the following statements is correct?

- (1) All three substances are solids at 40°C.
- (2) Substance Z has the lowest melting point.
- (3) Substance X has the lowest melting point.
- (4) The melting point of substance Y is 150°C.

23. Raju cut out shapes from three sheets X, Y and Z as shown below. The sheets were of the same size but made of different materials.

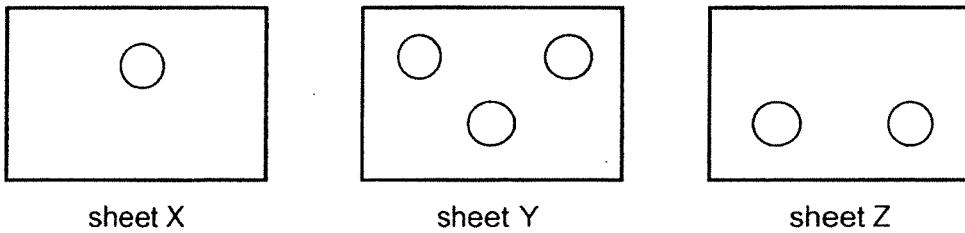

He arranged the three sheets in a straight line and shone a torch on them to observe the shadow formed on the screen.

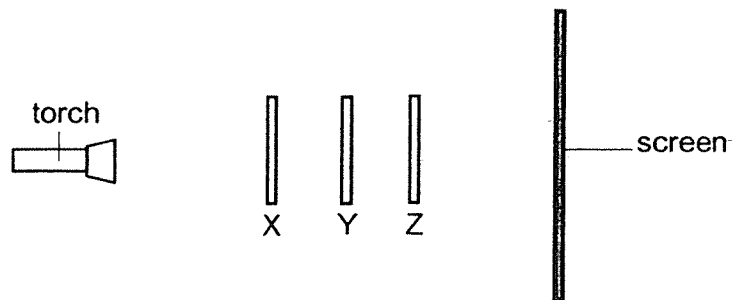

The shadow observed on the screen is shown below.

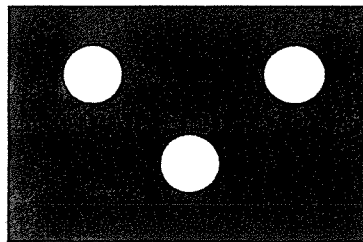

Which one of the following correctly identifies the material of each sheet?

	Sheet X	Sheet Y	Sheet Z
(1)	clear plastic	wood	frosted glass
(2)	metal	wood	clear plastic
(3)	frosted plastic	frosted glass	clear glass
(4)	clear glass	metal	clear plastic

24. Four objects A, B, C and D were suspended from a wooden rod as shown in Diagram 1.

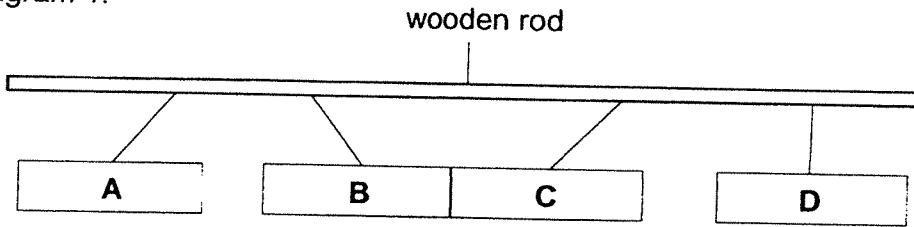

Diagram 1

The positions of objects C and D were changed. Diagram 2 shows what happened after the change.

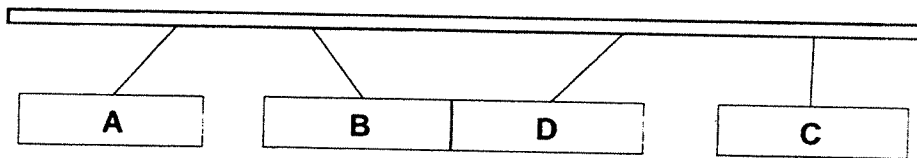
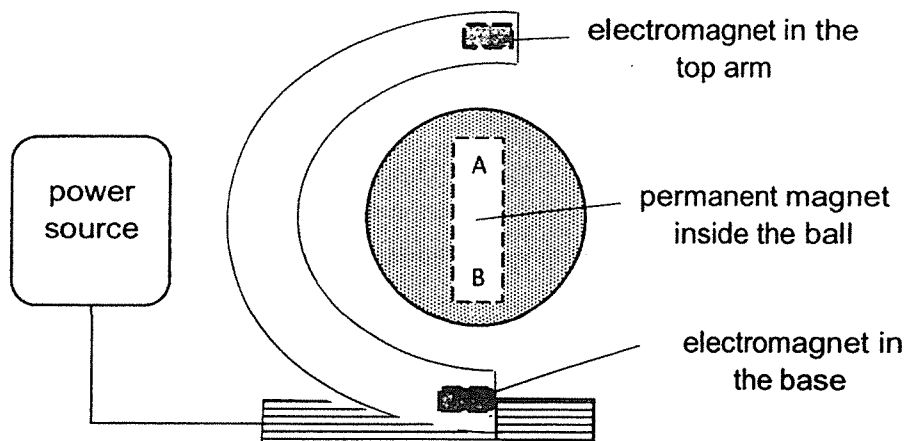

Diagram 2

Which of the following best describes the objects?

	A	B	C	D
(1)	magnet	magnet	magnet	magnet
(2)	magnet	magnet	magnetic material	magnetic material
(3)	magnetic material	magnetic material	magnet	magnet
(4)	magnetic material	magnetic material	magnetic materials	magnet

25. Muthu has a toy as shown below. When the power is switched on, the ball floats in mid-air.



This toy makes use of the electromagnets in the top arm and the base, as well as a permanent magnet inside the ball.

Which of the following options correctly shows the poles of the permanent magnet and the electromagnets?

	Permanent magnet		Electromagnet	
	A	B	Top arm	Base
(1)	North	South	North	North
(2)	South	North	North	South
(3)	North	South	North	South
(4)	South	North	South	South



RED SWASTIKA SCHOOL

SCIENCE 2021 SEMESTRAL EXAMINATION PRIMARY 5

Name : _____ ()

Class : Primary 5/ _____

Date : 2 November 2021

BOOKLET B

11 Questions
40 Marks

In this booklet, you should have the following:

- Page 18 to Page 32
- Questions 26 to 36

MARKS

	OBTAINED	POSSIBLE
BOOKLET A		50
BOOKLET B		40
TOTAL		90

Parent's Signature : _____

Answer all the questions in the spaces provided.

26. Luka conducted an experiment to find out how quickly bacteria P can reproduce when it is kept at different temperatures. His results are shown below.

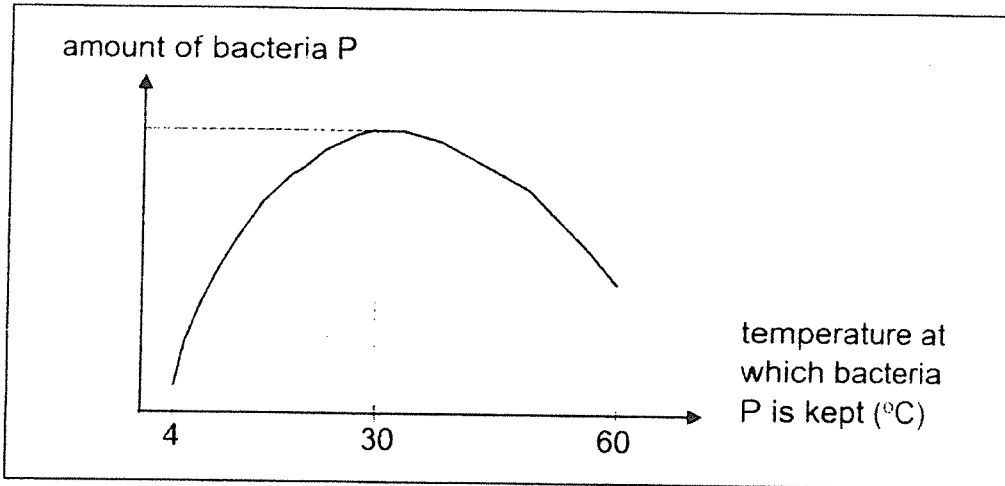

- (a) Based on the result, describe how the amount of bacteria P changes with temperature. (2m)

Luka placed three glasses of milk at different locations shown below.



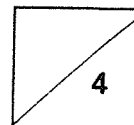

Temperature (°C)	Location
4	refrigerator
20	air-conditioned room
30	kitchen

- (b) Bacteria P can cause milk to spoil when it is present in large numbers. Based on Luka's experiment, which one of the locations would be the most ideal to store a glass of milk? Give a reason for your answer. (1m)

- (c) Luka's mother suggested to heat up the milk to 60°C. Based on the results of the experiment, explain why the milk may no longer be safe to drink. (1m)



27. Rafeal wanted to investigate the conditions needed for plant growth. Four pots of identical plants were placed in the same area within a garden. The diagram shows the four pots of plants after a few weeks.

				
Pot	W	X	Y	Z
Type of soil	garden soil	garden soil	sandy soil	clayey soil
Availability of water	Yes	Yes	Yes	Yes
Availability of fertiliser	Yes	No	Yes	No

(a) Which two pots should she use to compare the effect of the type of soil on the plant growth? (1m)

Variable	Pots to compare
Type of soil	

Rafeal conducted a second experiment to find how the amount of fertiliser affects leaf growth. He conducted a fair test, planting the same plants in five big pots, A, B, C, D and E. The pots are filled with garden soil. The results of his experiments are shown below.

Pot	A	B	C	D	E
Amount of fertiliser (g)	0	5	10	15	20
Average surface area of a leaf after two weeks (cm ²)	10	25	34	18	12

(b) What can Rafeal conclude about the effect of fertiliser on leaf growth? (2m)

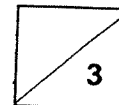

28. The graph below shows the changes in Fion's heart rate before, during and after running.

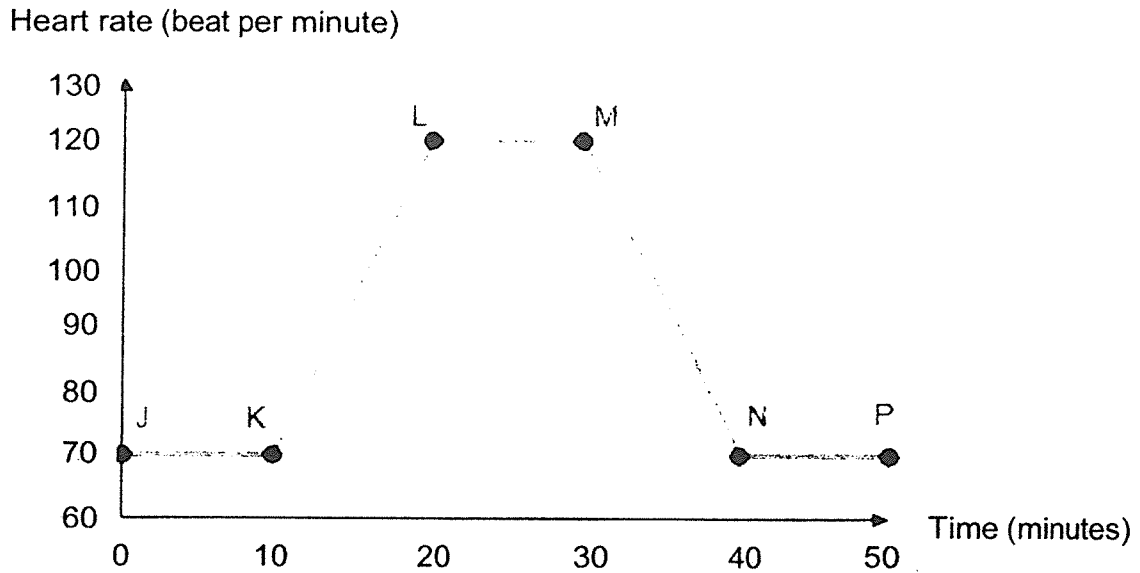

- (a) At which point, J, K, L, M, N, or P, did Fion stop running? (1m)

While running, Fion realised that her heart was beating very quickly.

- (b) Explain why Fion's heart rate increased when she started running. (2m)

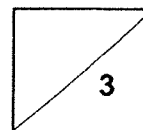

29. The arrows show the movement of a substance within the plant transport system.

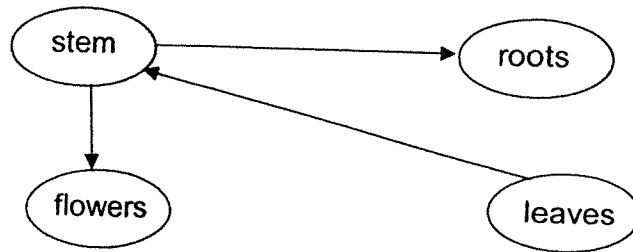

(a) What is the substance being transported? (1m)

An experiment was carried out on two similar plants, X and Y. The food-carrying tubes were removed from plant Y but not from plant X. The water-carrying tubes remained in the stem.

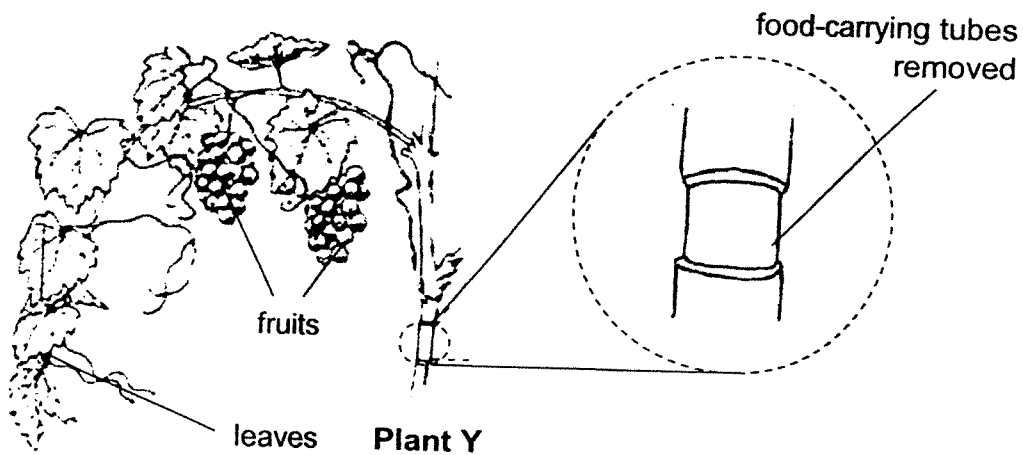

(b) Suggest why the remaining fruits on plant Y grew bigger than those on plant X after some time. (2m)

(c) After some time, plant Y died. Give a reason why removing the outer ring of the stem caused the plant to die. (1m)

30. Jane kept some mosquitoes at different temperatures. She observed the time taken for each stage of development in the mosquito's life cycle at the different temperatures.

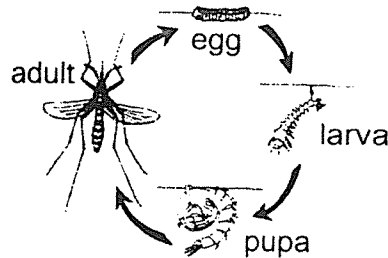

She recorded her results in the table below.

Stage in life cycle	Duration of stage at different temperature (days)			
	22°C	25°C	30°C	35°C
Egg	3	3	2	2
Larva	8	7	7	6
Pupa	4	3	3	2

- (a) Based on the information given above, at which temperature will the mosquito take the longest time to develop into an adult? (1m)

The graph below shows the temperature recorded at Country X from January to July.

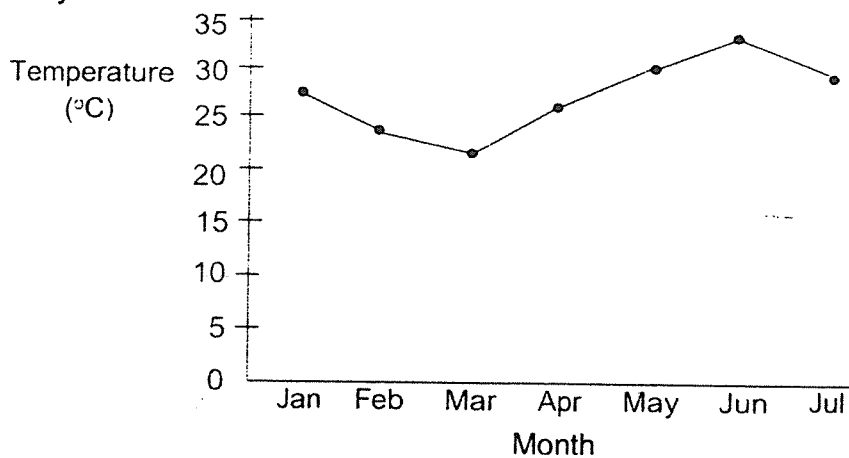

- (b) Based on the information given in the table and graph above, in which month will the number of adult mosquitoes most likely be the highest? Explain your answer. (1m)

30. Male mosquitoes do not bite and do not spread dengue fever. When a male mosquito carrying bacteria Y mates with a female mosquito, the eggs will not hatch.
- (c) Some male mosquitoes carrying bacteria Y were released into Country X. The number of dengue cases decreased after the release of these male mosquitoes. Explain why. (2m)

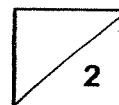

31. Winda conducted an experiment to find out if the length of structure X of a seed affects the distance it travels. She prepared three identical seeds, A, B and C, with different lengths of structure X being removed.

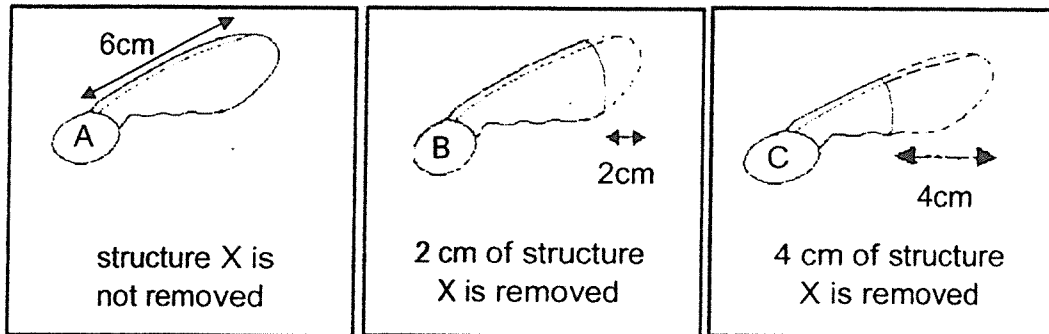

She dropped seed A from a height (H) in front of a fan as shown. She measured the distance (D) travelled by seed A.

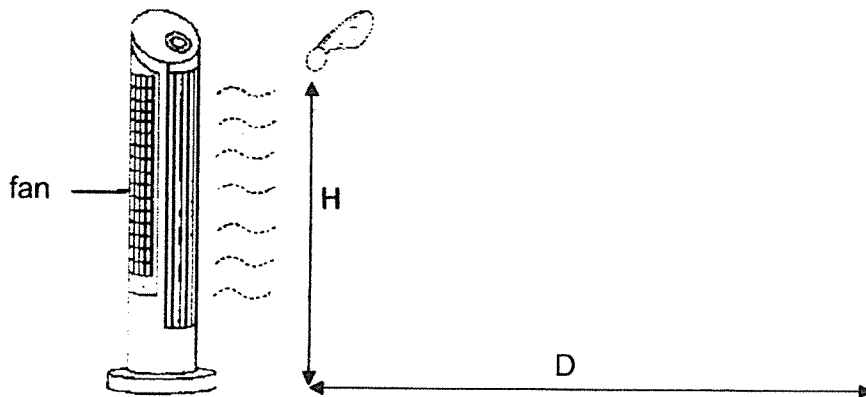

She repeated the experiment with seed B and C. The readings are shown below.

Seed	Length of structure X removed from the seed (cm)	Distance (D) travelled by the seed (cm)
A.	0	125
B	2	85
C	4	20

- (a) Based on the information above, what is the relationship between the distance, D, travelled by the seed and the length of structure X removed from the seed? (1m)

31. Winda removed the whole of structure X from the seed of plant P, as shown below.



seed (structure X is removed)

- (b) What would be a possible distance, D , travelled by the seed when dropped from the same height? (1m)

- (c) Explain your answer for part (b). (1m)

- (d) Winda concluded that not removing structure X will allow the young of plant P to grow healthily. Explain why this is so. (2m)

32(a) Mr Tan wants to install a fan and two lights in his bedroom. He can choose from either circuit below.

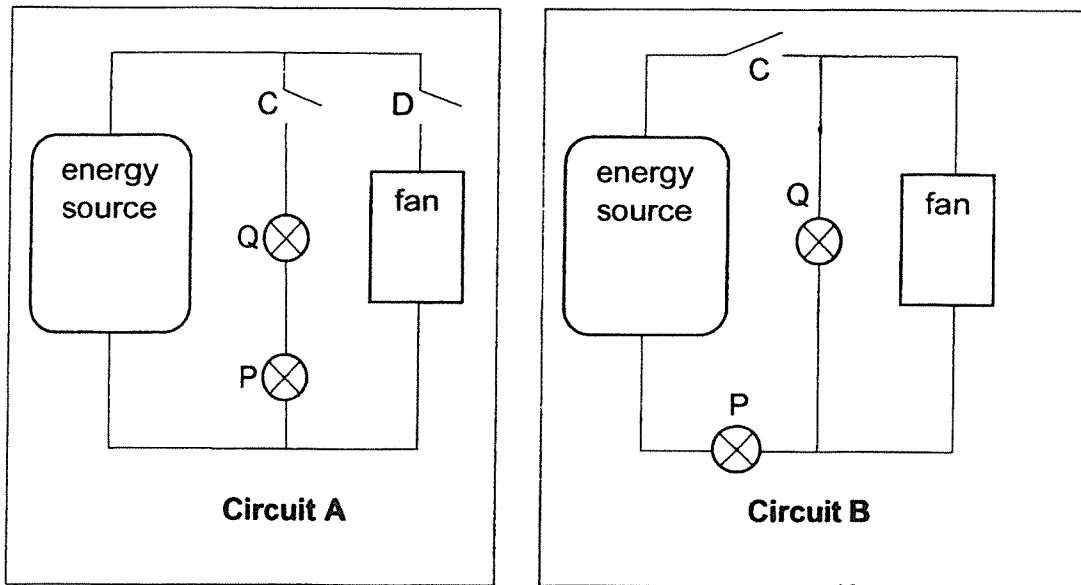

(i) Which circuit, A or B, should Mr Tan use if he wants to control the lights and fan separately. Explain your answer. (1m)

(ii) Mr Tan wanted only the fan and one bulb to be switched on. If he were to use circuit B for his bedroom, where should he place the switch to control the bulbs separately?

Draw an 'X' to show the location of the additional switch in circuit B above. (1m)

(iii) What is the advantage of arranging the bulbs and the fan in a parallel circuit? (1m)

33. Muthu made a simple set-up to collect clean water from muddy water. The set-up below was placed under the hot sun for a few hours. After several hours, he saw some clean water collected at the base of the steel container as shown.

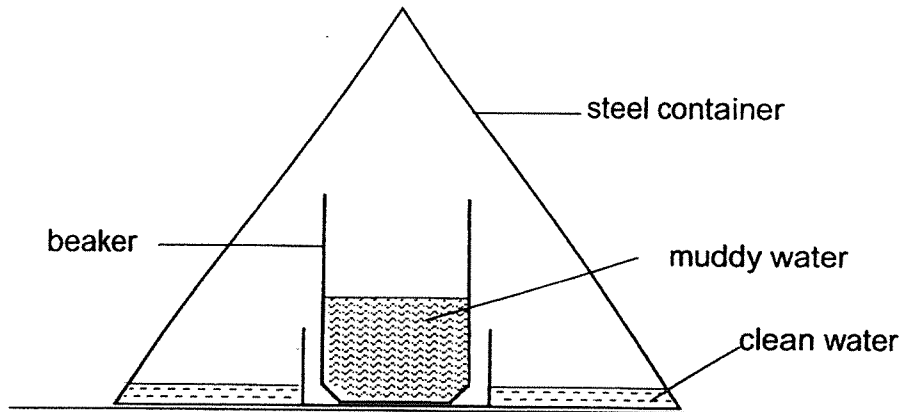

- (a) Explain how the clean water was collected in the steel container. (2m)

- (b) Suggest one change Muthu could make to the set-up if he wanted to collect more clean water. (1m)

34. May had two identical containers, X and Y, each having a capacity of 500 cm^3 . She placed them on a balance as shown in the diagram below.

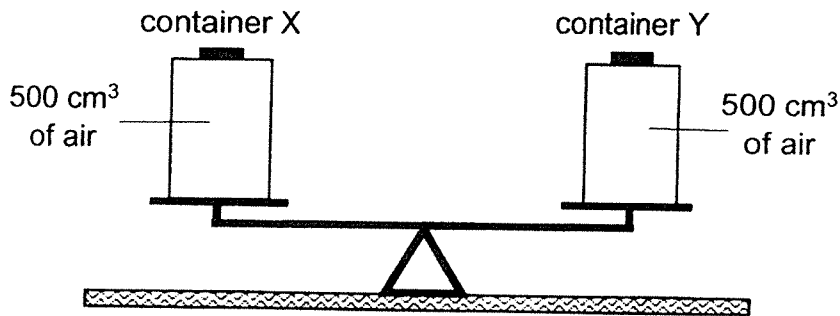

- (a) May pumped in another 100 cm^3 of air into container Y. Put a tick (\checkmark) in the box below to indicate the result she would observe. (1m)

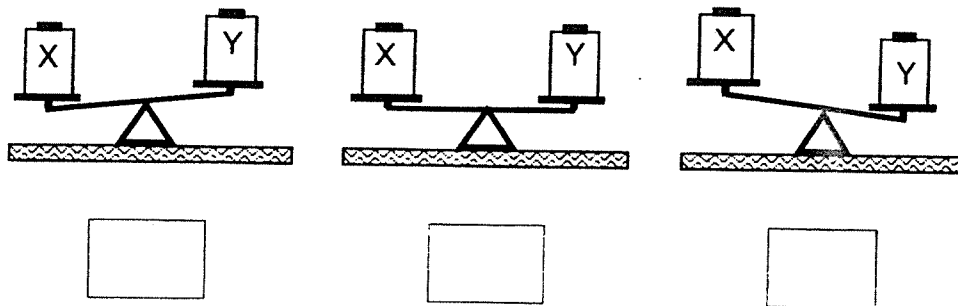

- (b) Which property of air is shown in your answer for part (a)? (1m)

- (c) May has two syringes, A and B. Syringe A is filled with water and syringe B is filled with air. She was able to push the plunger inwards for syringe B but she was unable to push the plunger inwards for syringe A.



State one difference in the property between water and air in a syringe. (1m)

35. Hock Seng conducted an experiment as shown below to find out more about the property of materials X and Y.

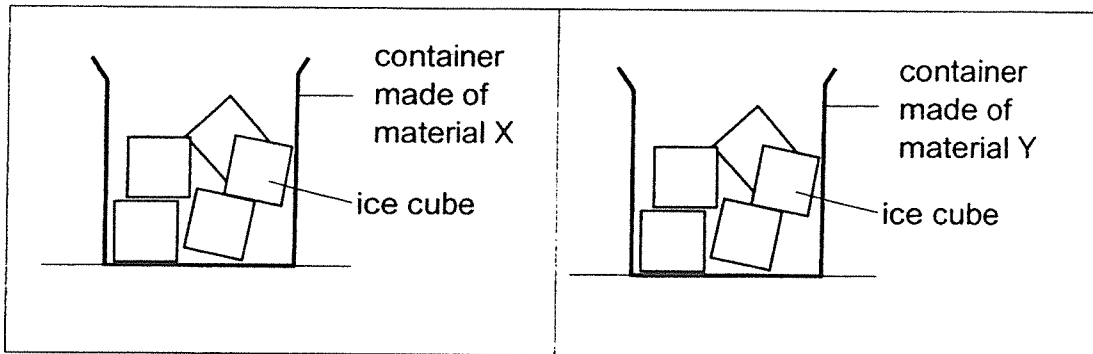

The results of his experiment are shown below.

Material of the container	Time taken for all the ice to melt completely (min)
X	130
Y	80

- (a) What is the aim of Hock Seng's experiment? (1m)
- _____
- _____
- (b) Based on the results, what can Hock Seng conclude about the property of the materials X and Y from his experiment? (1m)
- _____
- _____
- (c) Other than what is observed in the diagrams, state another important variable that has to be kept constant to ensure a fair test. (1m)
- _____
- _____

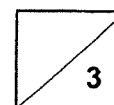

36. Jack boiled the same amount of water in three pots made of the same material as shown below.

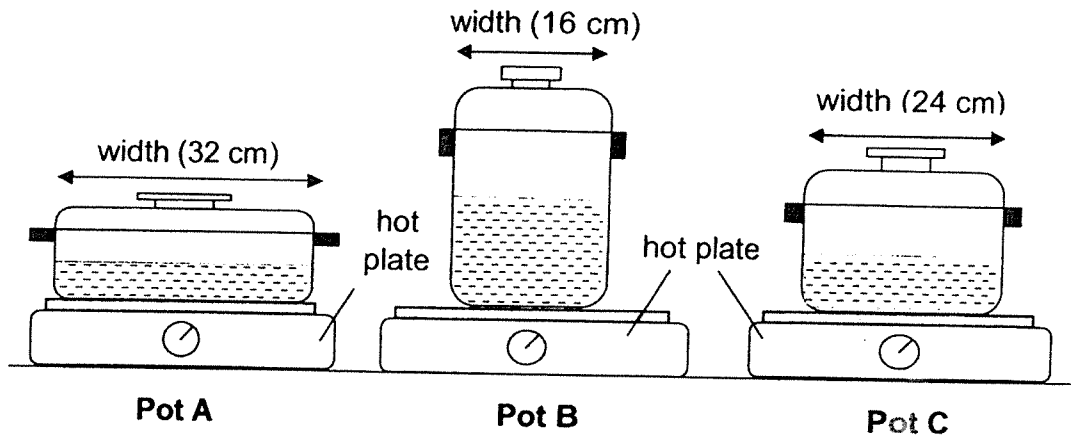

He started heating the pots of water on identical hot plates at the same time. He measured the time taken for the water in each pot to boil. His results are shown below.

Pot	A	B	C
Time taken for water to boil (mins)	6	8	7

- (a) Using the findings from Jack's experiment, explain why pot B took the longest time to boil. (1m)

36. Jack wanted to find out how long he could hold onto the cups below with his bare hands. He used two cups made of the same material and of the same width. He then filled both cups with the same amount of hot water at 90°C .

The diagram below shows the position of his hand when he held each cup.

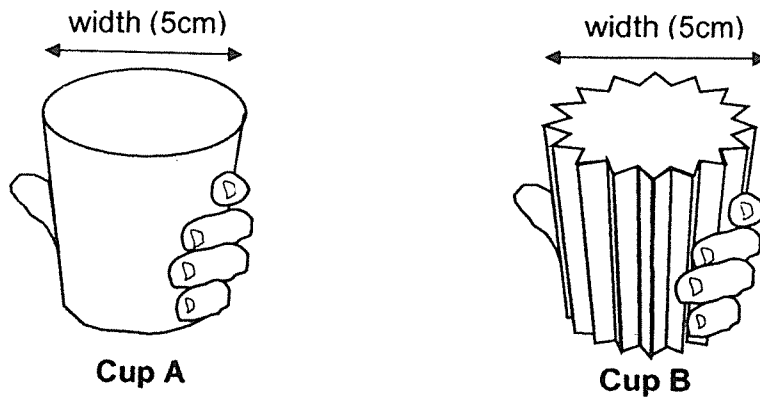

- (b) Which cup, A or B, could Jack hold for a longer period of time before it was too hot for him? Explain your answer. (2m)

END OF BOOKLET B
PLEASE CHECK YOUR ANSWERS.

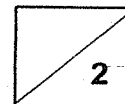

ANSWER KEY

YEAR : 2021
LEVEL : PRIMARY 5
SCHOOL : RED SWASTIKA SCHOOL
SUBJECT : SCIENCE
TERM : SA2

BOOKLET A

Q1	1	Q2	2	Q3	4	Q4	3	Q5	4
Q6	4	Q7	1	Q8	3	Q9	2	Q10	3
Q11	1	Q12	2	Q13	4	Q14	3	Q15	4
Q16	1	Q17	4	Q18	3	Q19	3	Q20	2
Q21	1	Q22	2	Q23	4	Q24	2	Q25	3

BOOKLET B

Q26	<p>(a) As the temperature at which bacteria is kept increases, the amount of bacteria increases until 30°C. After 30°C, the amount of bacteria decreases.</p> <p>(b) In the refrigerator. There is the lowest amount of bacteria found at 4°C.</p> <p>(c) There is still same bacteria present at 60°C. Hence, heating the milk does not make it safe to drink.</p>
Q27	<p>(a) Type of soil: W and Y OR X and Z</p> <p>(b) As the amount of fertiliser increases to 10g, the leaf growth increased. As the amount of fertiliser increased from 10g to 20g, the leaf growth decrease.</p>
Q28	<p>(a) M</p> <p>(b) The heart pumps blood faster to transport more oxygen and digested food to all parts of the body to release more energy.</p>
Q29	<p>(a) Food</p> <p>(b) Fruits grew bigger on plant Y because the food made by the leaves were not transported to the roots as the food-carrying tube were removed. Hence, the food made were transported to the fruits.</p> <p>(c) As the food carrying-tubes were removed, food cannot be transported to the roots. The roots would eventually die and cannot absorb water for the plant, causing the plant to die due to lack of water.</p>
Q30	<p>(a) 22°C</p> <p>(b) In the month of June. The temperature is the highest. Hence, the mosquitoes will take the shortest time to develop into adults.</p> <p>(c) Less eggs were hatched which results in less young produced and</p>

develop to adults to spread dengue fever.

- Q31** (a) As the length of structure X removed from the seed increases, the distance travelled by the seed decreases.
(b) Any number below 20 cm
(c) There is no structure so it cannot glide a further distance
(d) By not removing structure X from the fruit, the seed will be dispersed further away from parent plant. This will prevent overcrowding and competition for space.

- Q32** (a)(i) Circuit A. Circuit A has 2 switches while circuit B has only one. If switch C is closed, the light bulbs are in a close circuit/If switch D is closed, the fan is in a closed circuit.

(a)(ii)

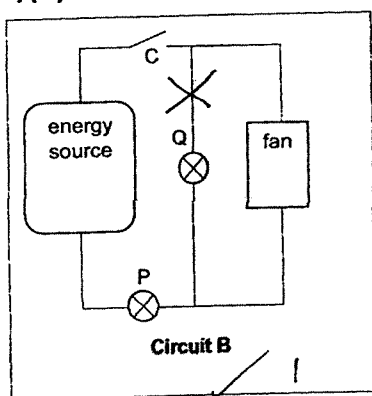

(a)(iii) If the bulbs fuses/fan is faulty, the electric current can flow through and form a closed circuit to allow the other to continue working.

(b)(i)

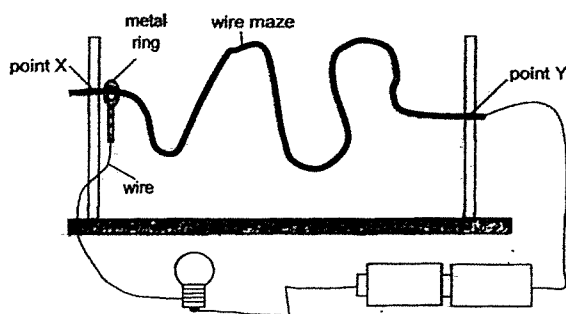

(b)(ii) The metal ring is a conductor of electricity. It will form a closed circuit which allows electricity to flow through hence lighting up the bulb.

- Q33** (a) The muddy water in the container gains heat from the hot sun and evaporate into hot water vapour. When the water vapour comes into contact with the cooler inner surface of the steel container, it loses heat and condense to form water droplets. The water droplets then flow down the container and collected at the base.
(b) Use a beaker with a bigger expose surface area to increase the rate of evaporation. OR Heat the beaker with the muddy water to increase the rate of evaporation.

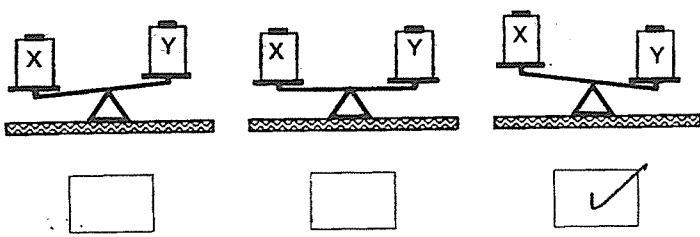
<p>Q34</p>	<p>(a)</p>  <p>(b) Air has mass (c) Water which is a liquid has a definite volume whereas air which is a gas has no definite volume. OR Water which is a liquid cannot be compressed but air which is a gas can be compressed.</p>
<p>Q35</p>	<p>(a) The aim of the experiment is to find out which material X or Y is a better conductor of heat. (b) Material Y is a better conductor of heat than material X (c) The temperature of the surrounding air should be the same. The location where the experiment is conducted should be the same.</p>
<p>Q36</p>	<p>(a) Since the surface area of part B in contact with the hot plate is the least it took the longest time for the pot to gain heat from the heat source. (b) Cup B. There are gaps in cup B resulting in a smaller exposed surface area of the cup in contact with Jack's hand. Heat from the hot water will be conducted at a slower rate to Jack's hand allowing him to hold up B for a longer period of time.</p>

3
END