



RAFFLES GIRLS' PRIMARY SCHOOL

Practice Paper 3

Name : _____

Index No.: _____

Class: P5 _____

SCIENCE

Duration: 1 h 45 min

SECTION A (28 x 2 marks)

For each question from 1 to 28, four options are given. One of them is the correct answer. Make your choice (1, 2, 3 or 4). Shade the correct oval (1, 2, 3 or 4) on the Optical Answer Sheet (OAS) provided.

1. The characteristics of organisms A and B are shown in the table below.

Characteristic	Organism	
	A	B
Has spores	Yes	Yes
Makes its own food	No	Yes

Which of the following organisms are A and B?

	A	B
(1)	fem	mushroom
(2)	moss	tomato plant
(3)	mushroom	fem
(4)	tomato plant	moss



2. The flow chart below shows how organisms A, B, C and D are grouped.

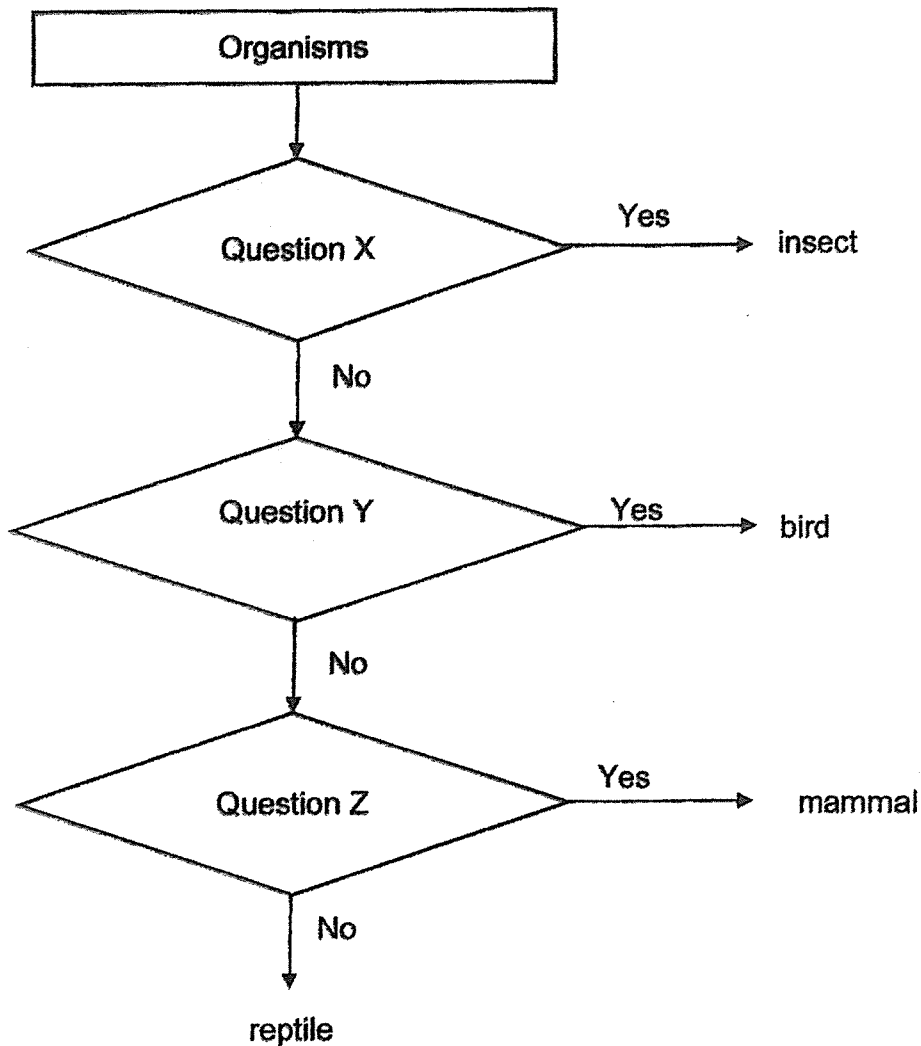

Which of the following is correct?

	Question X	Question Y	Question Z
(1)	Does it have hard outer covering?	Does it have a beak?	Does it lay eggs?
(2)	Does it have wings?	Does it have hard outer covering?	Does it lay eggs?
(3)	Does it have feathers?	Does it have wings?	Does it give birth to young alive?
(4)	Does it have six legs?	Does it have feathers?	Does it give birth to young alive?

3. The graph below shows the number of days spent in each stage of life cycle of animals P and Q.

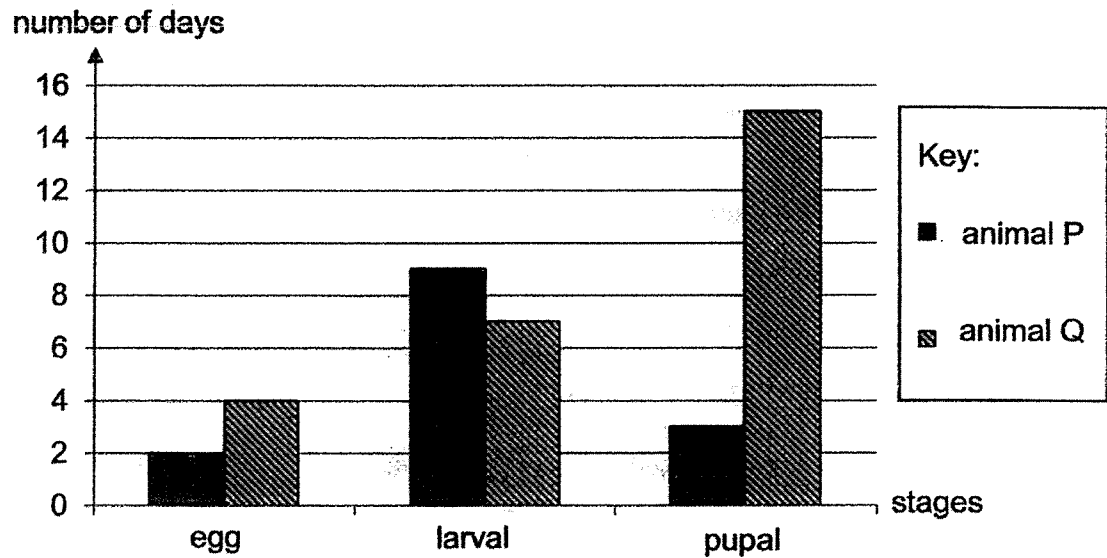

Based on the graph above, on which day will animals P and Q start the stage where they feed the most respectively?

	Animal P	Animal Q
(1)	2 nd day	4 th day
(2)	3 rd day	5 th day
(3)	8 th day	7 th day
(4)	12 th day	8 th day

4. Study the graph below on the change observed during seed germination.

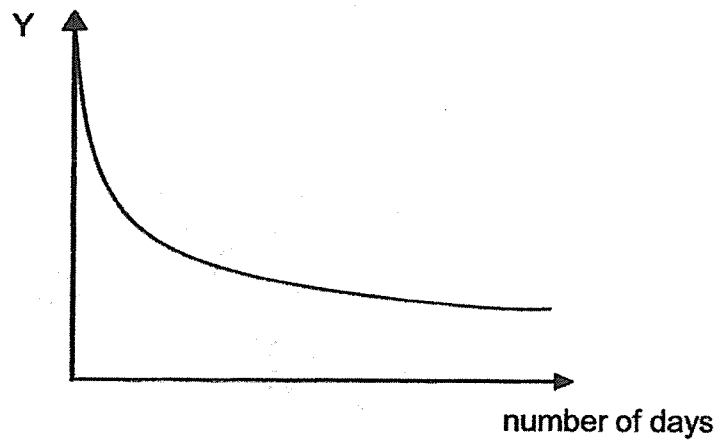

What could Y represent?

- (1) Mass of the seedling
- (2) Height of the seedling
- (3) Mass of the seed leaf
- (4) Length of the roots

5. Lucy conducted an experiment using two insect-pollinated flowers, X and Y, from the same plant. The diagram below shows the cross-section of one of the flowers. A, B, C and D are parts of the flower.

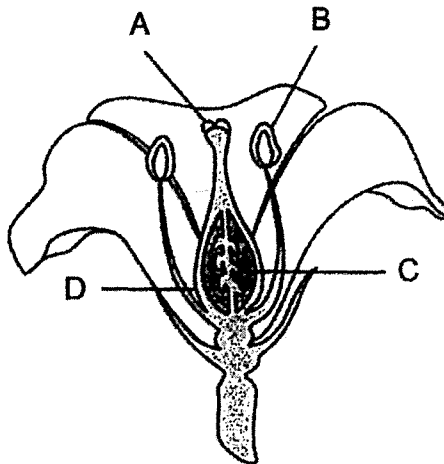

cross-section of the flower

She removed a part from flower X and another part from flower Y. She observed the development of the flower over time and recorded it in the table below.

Flower	Development of fruit
X	yes
Y	no

Which of the following shows the parts removed from the flowers?

	Flower X	Flower Y
(1)	A	B
(2)	C	D
(3)	C	B
(4)	B	D

6. Diagram 1 below shows the distribution of the plants C, D and E on a piece of land.

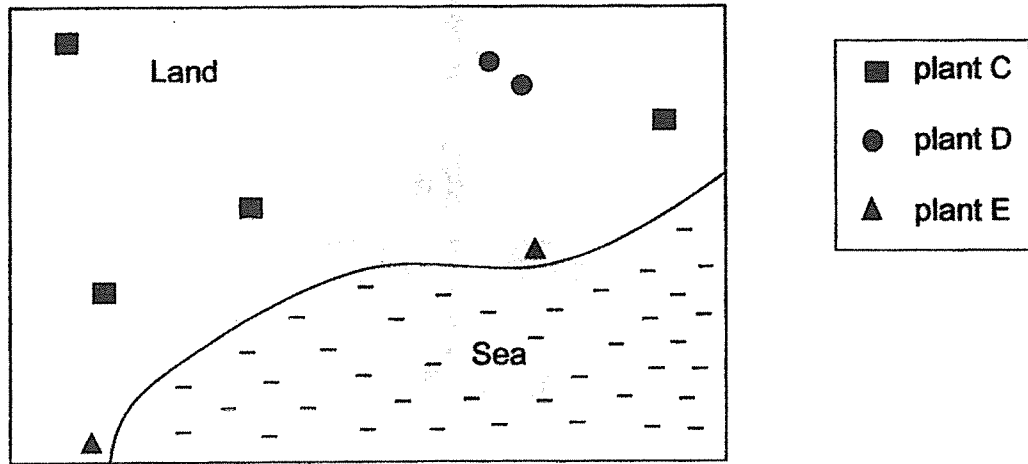

Diagram 1

Diagram 2 below shows the number of plants on the same piece of land after one year.

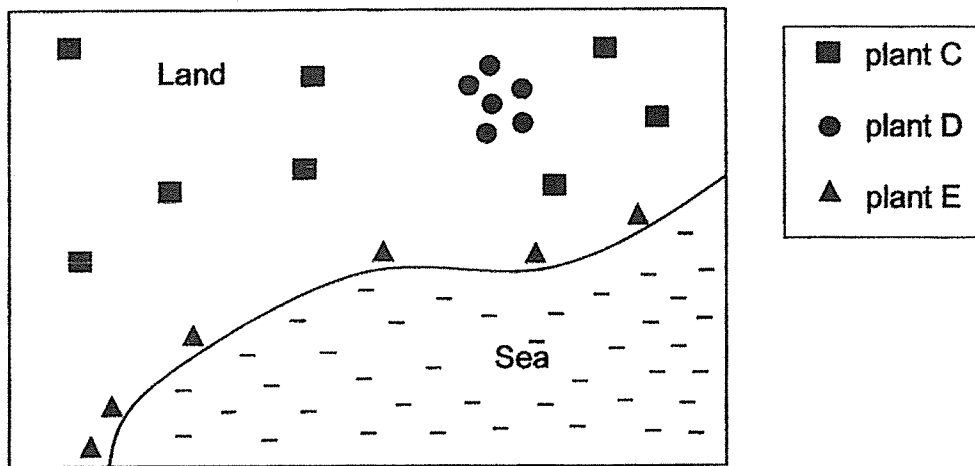

Diagram 2

Which of the following shows the correct methods of seeds dispersal for plants C, D and E?

	Plant C	Plant D	Plant E
(1)	splitting	animals	wind
(2)	wind	water	animals
(3)	animals	splitting	water
(4)	water	wind	splitting

7. The diagram below shows a plant growing in the soil.



Based on the observation above, which of the following statement(s) about the plant is/are correct?

- A It has a weak stem.
- B It can make its own food.
- C It reproduces by spores.

- (1) B only
- (2) A and B only
- (3) A and C only
- (4) A, B and C

8. Which of the following correctly represents the direction of blood flow to certain parts of the human body?

(1)

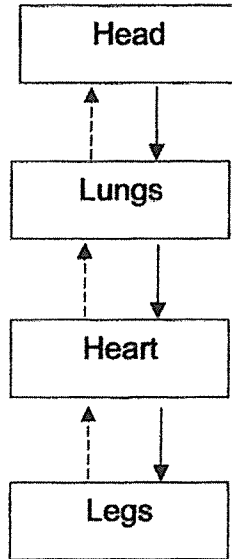

(2)

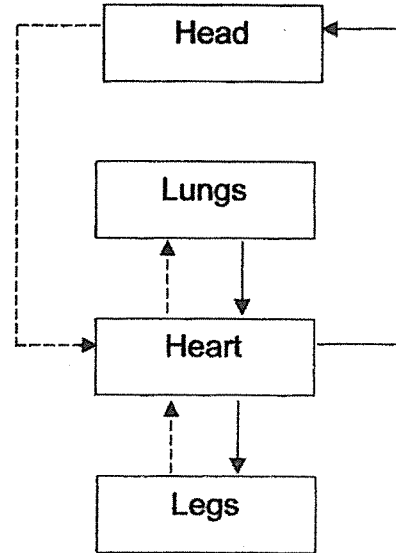

(3)

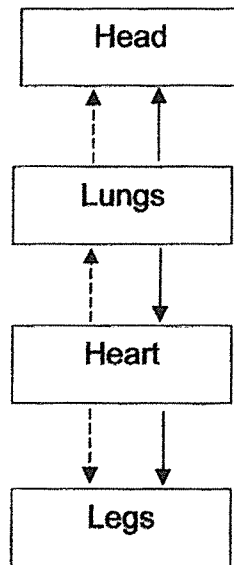

(4)

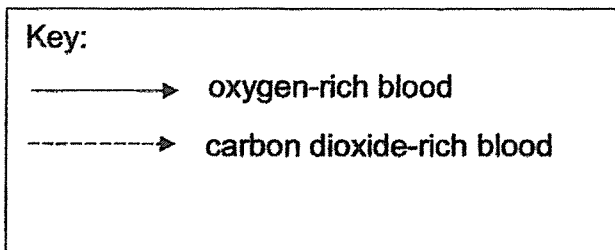
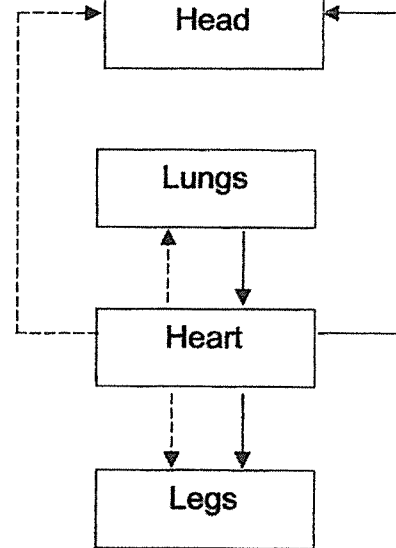

9. The diagram below shows a person swimming in the pool.

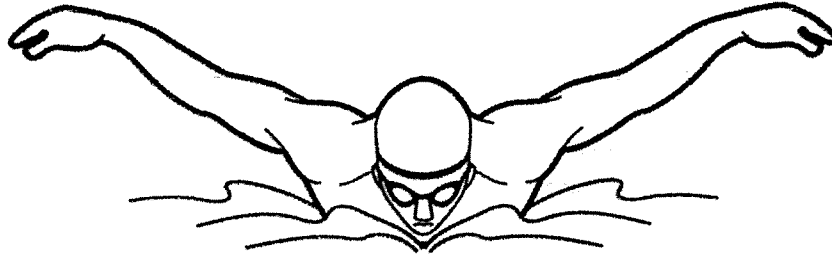

Which of the following shows the systems required to work together to enable him to swim?

Systems				
Digestive	Circulatory	Respiratory	Muscular	Skeletal
(1)			√	√
(2)	√	√		√
(3)	√		√	√
(4)	√	√	√	√

10. The table below shows the presence of the part(s) in three cells, X, Y and Z indicated by the tick (√).

Part	X	Y	Z
Nucleus	√	√	
Cytoplasm	√	√	√
Chloroplast			
Cell wall	√		
Cell membrane	√	√	√

Which of the following is/are animal cells?

- (1) X only
- (2) Y only
- (3) Y and Z only
- (4) X, Y and Z only

11. Which of the following statements state the difference between the inhaled and exhaled air from a human at room temperature correctly?

- A Inhaled air is cooler than exhaled air.
- B Exhaled air has less oxygen than inhaled air.
- C Inhaled air has less water vapour than exhaled air.
- D Exhaled air has more dust particles than inhaled air.

- (1) A and C only
- (2) B and D only
- (3) A, B and C only
- (4) B, C and D only

12. Mei Yee conducted an experiment to find out the rate of heartbeats in three different animals P, Q and R. She used a live and dead specimens of each animal in her investigation. Then she recorded her findings in the table below.

Animals	P	P	Q	Q	R	R
Live or Dead	Live	Dead	Live	Dead	Live	Dead
Mass (kg)	1	1	5	5	90	90
Number of heartbeats per minute	205	0	192	0	60	0

Based on her findings, which of the following statements are true?

- A There is no heartbeat in a dead animal.
- B Live animal P has the greatest number of heartbeats per minute.
- C The greater the mass of a live animal, the fewer the number of heartbeats per minute.

- (1) A only
- (2) A and C only
- (3) B and C only
- (4) A, B and C

13. The following table compares the human circulatory system and the plant transport system.

	Plant transport system	Human circulatory system
A	The water transport system extends from the roots to the other parts of the plant.	The circulatory system involves the heart pumping blood to the different parts of the body.
B	Oxygen is taken in through the chloroplasts.	Gaseous exchange occurs in the lungs.
C	Food is transported from the leaves to the rest of the plant by the food-carrying tubes.	The blood vessels transport oxygen-rich blood, digested food and water to the rest of the body.

Which of the following statements are correct?

- (1) A only (2) B only
(3) A and C only (4) B and C only

14. The diagram shows parts of a plant P, Q and R.

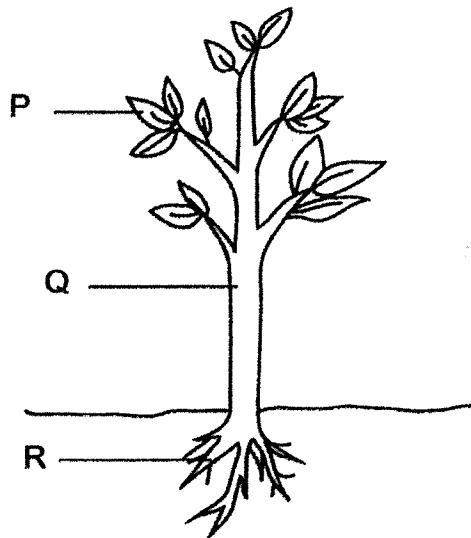

Which of the following part(s) of the plant contain(s) water-carrying tubes?

- (1) R only
(2) P and Q only
(3) Q and R only
(4) P, Q and R

15. The diagrams below show some processes involved when water changes from one state to another.

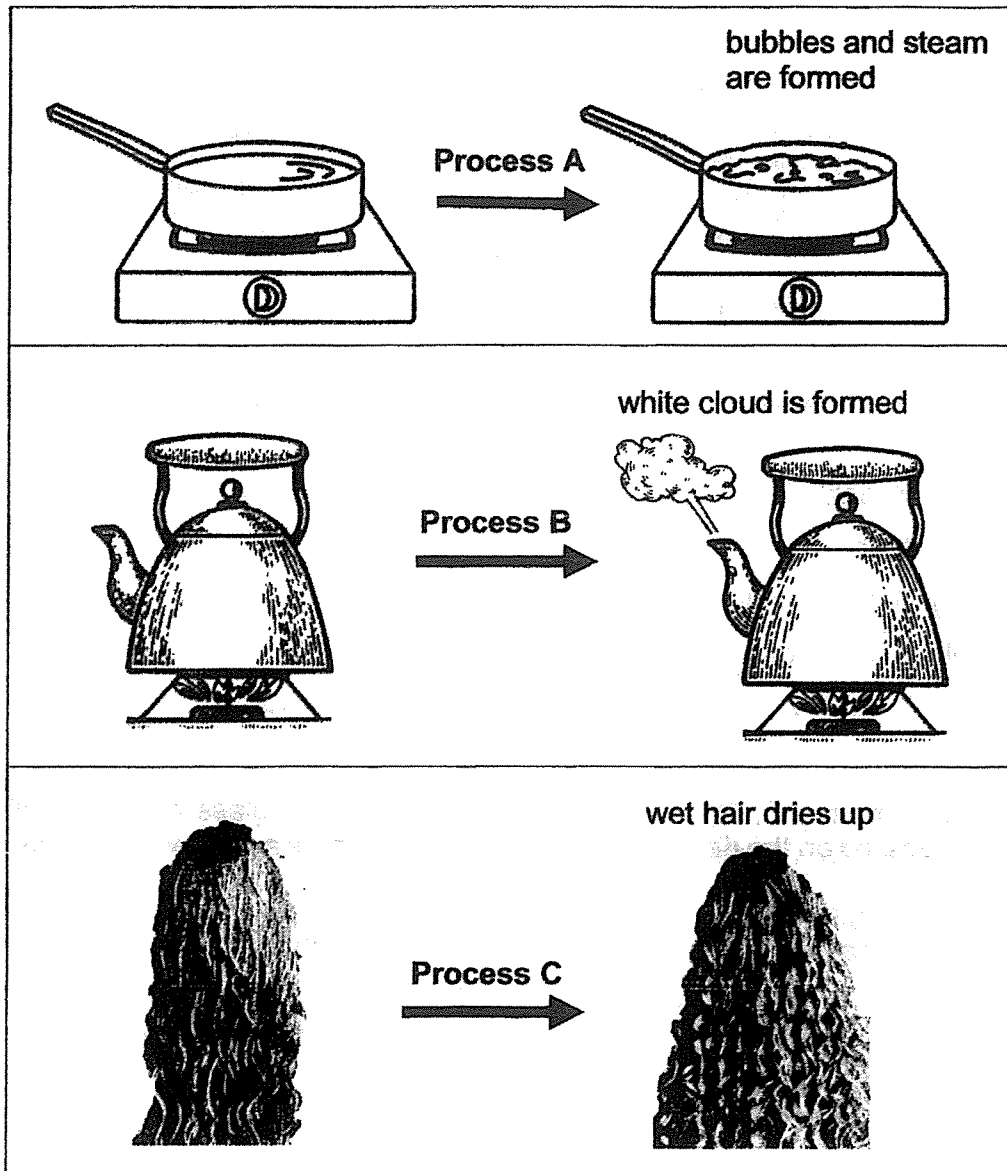

What are processes A, B and C?

	Process A	Process B	Process C
(1)	Boiling	Condensation	Evaporation
(2)	Evaporation	Condensation	Boiling
(3)	Condensation	Boiling	Evaporation
(4)	Evaporation	Melting	Boiling

16. The diagram below shows the water cycle. The arrows represent different processes in a water cycle.

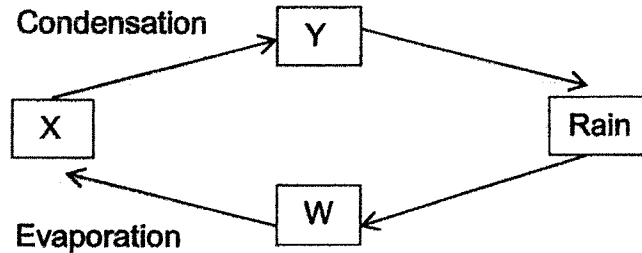

At which stage(s), W, X or Y, in the water cycle, is water in the liquid state?

- (1) W only
 - (2) X only
 - (3) W and Y only
 - (4) X and Y only
17. Four rooms, P, Q, R and S, were separated by glass panels. Water droplets appeared on the different sides of the glass panels as shown in the diagram below.

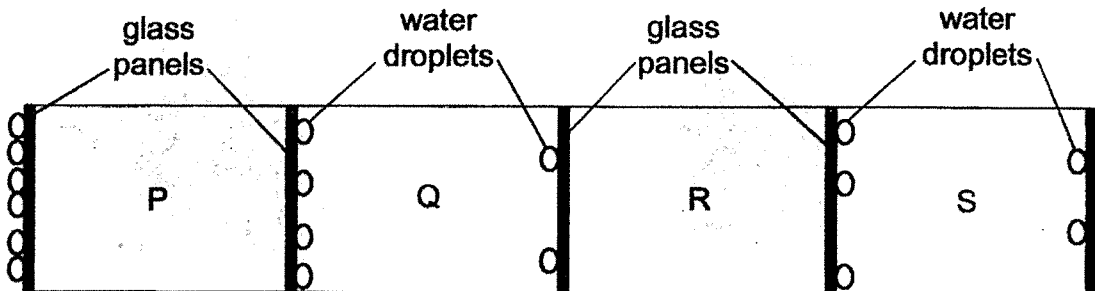

In which room was the temperature the lowest?

- (1) Room P
- (2) Room Q
- (3) Room R
- (4) Room S

18. Azlin shines a torch on the metal container as shown below.

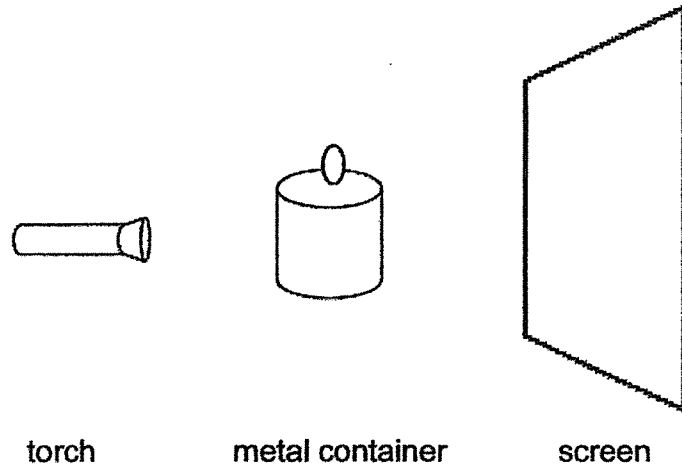

Which one of the following shows the shadow of the metal container cast on the screen?

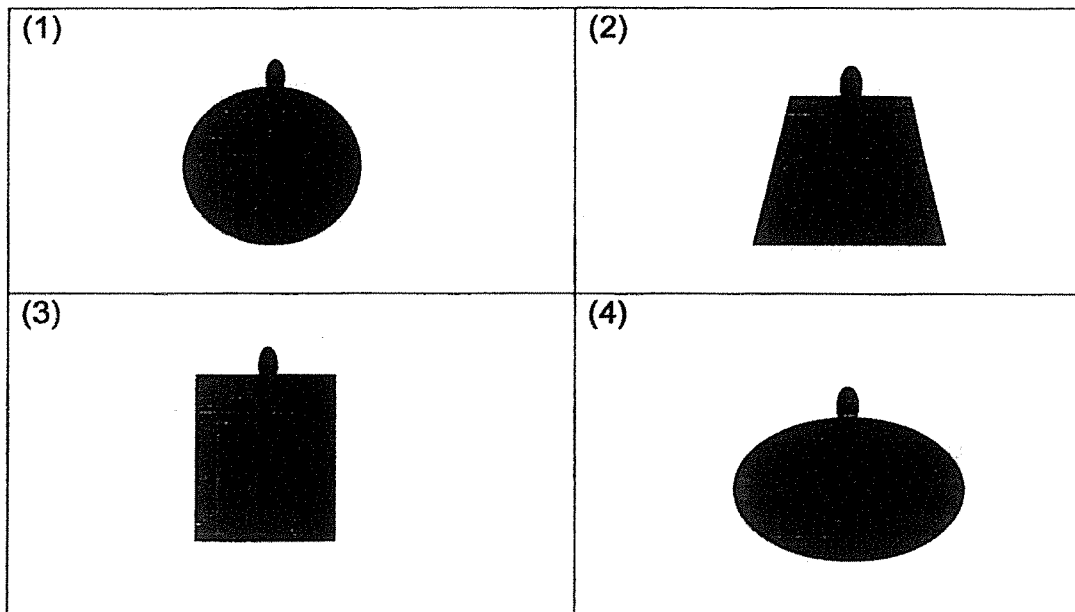

19. Siti placed 200 ml of different liquids, A, B and C, in three identical beakers. She then placed each beaker on identical tripod stands and shone the identical torch through each of them.

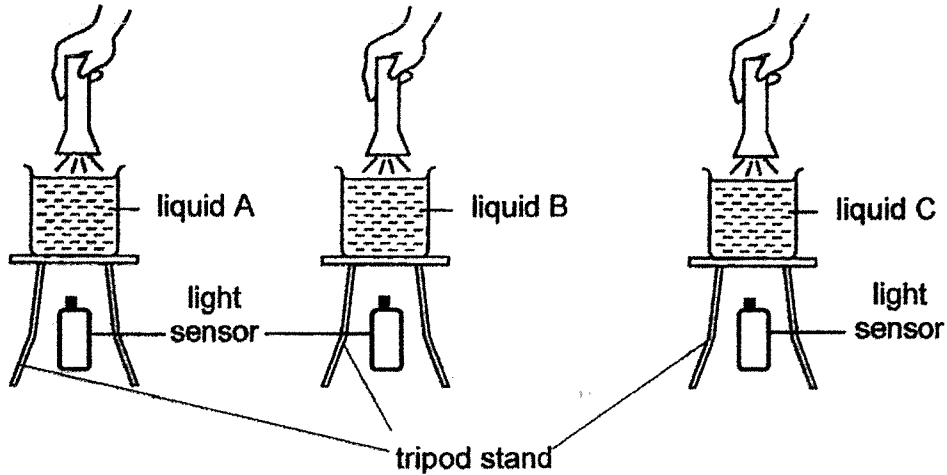

She recorded the amount of light detected by the light sensor in the table below:

Amount of light (lux)		
Liquid A	Liquid B	Liquid C
100	500	0

Based on the above results, arrange the liquids A, B and C starting with the one that allows most light to pass through.

(1)	<p>liquid B liquid A liquid C</p> <p>most light can pass through least light can pass through</p>
(2)	<p>liquid B liquid C liquid A</p> <p>most light can pass through least light can pass through</p>
(3)	<p>liquid C liquid A liquid B</p> <p>most light can pass through least light can pass through</p>
(4)	<p>liquid C liquid B liquid A</p> <p>most light can pass through least light can pass through</p>

20. Raju walked past a lighted street lamp on a dark night.

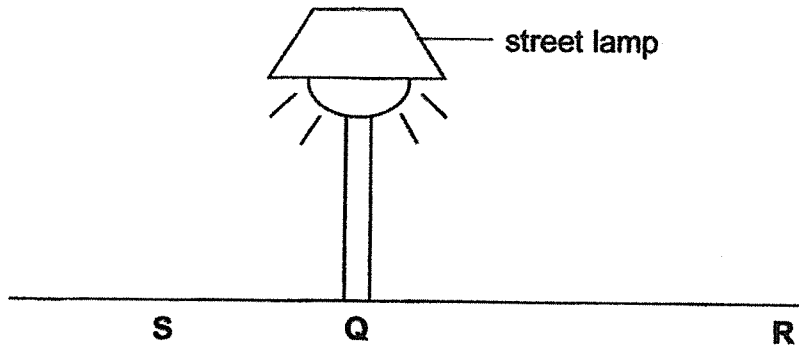

Which of the following graphs best represents the changes in the length of Raju's shadow when he was at positions Q, R and S, respectively?

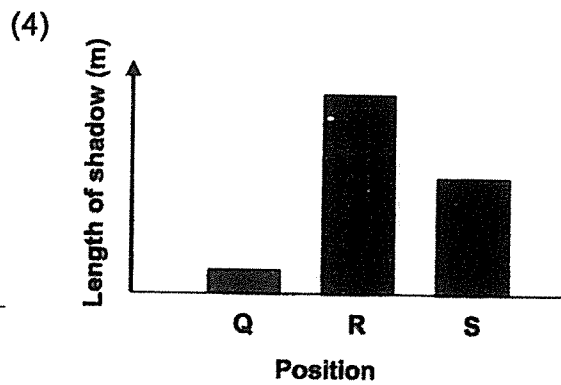
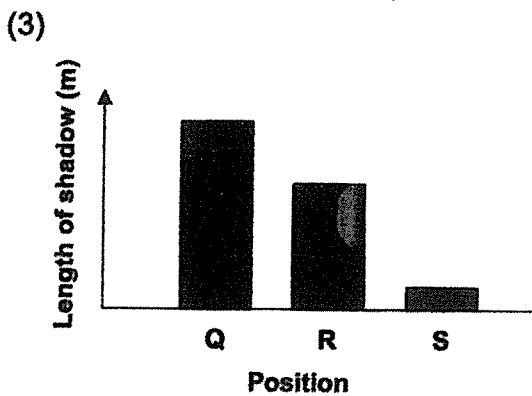
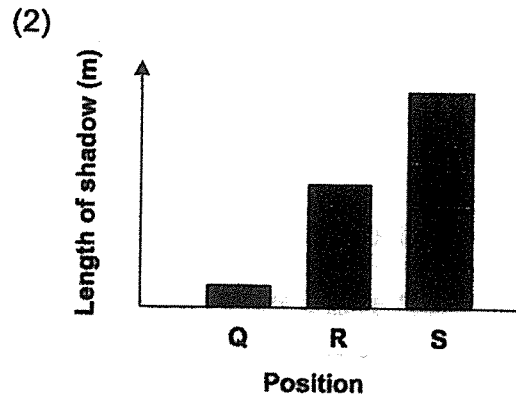
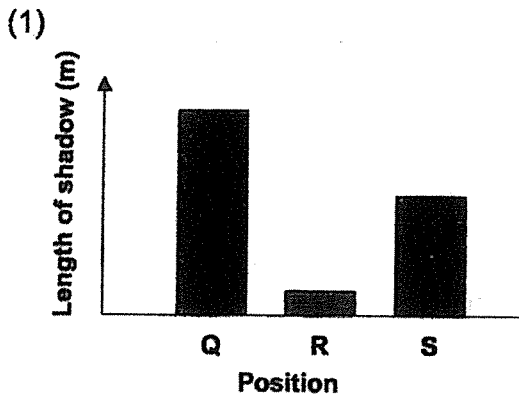

21. Four pans of the same size are shown below.

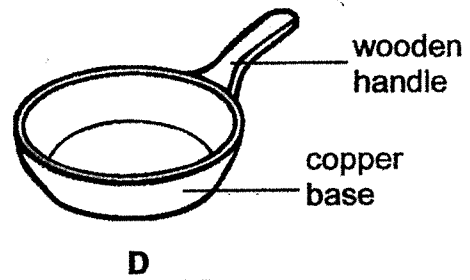
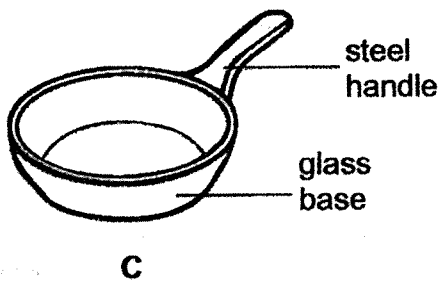
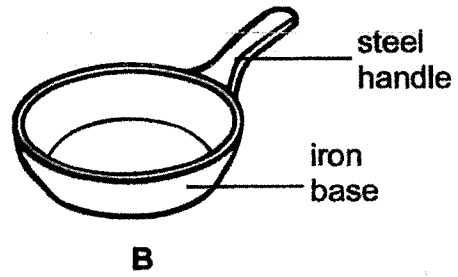
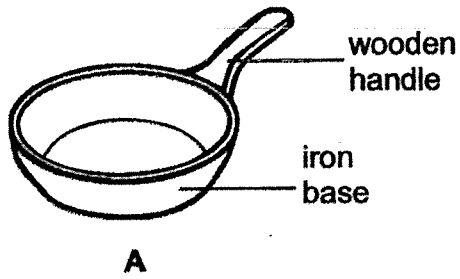

Which two pans can be used to show that steel is a better conductor of heat?

- (1) A and B
- (2) A and C
- (3) B and C
- (4) C and D

22. A canned drink, at room temperature, is placed into a basin of water at 10°C as shown below.

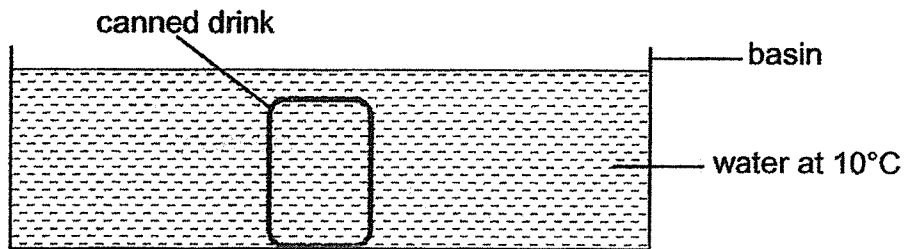

Which of the following graphs represent the changes in the temperatures of the liquids in the basin and in the can?

- (1) Temperature (°C)

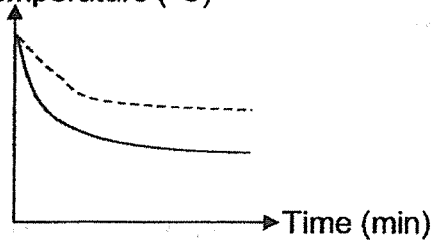

Key:

water in the basin —————
canned drink - - - - -

- (2) Temperature (°C)

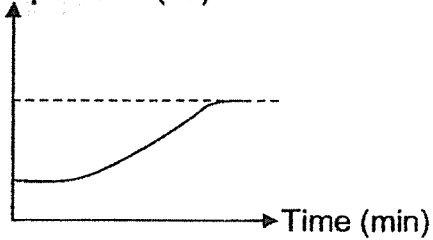

- (3) Temperature (°C)

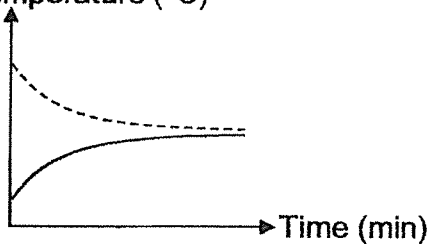

- (4) Temperature (°C)

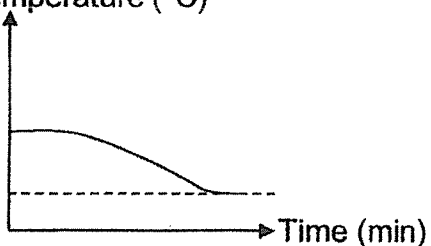

23. Jill placed a plastic spoon and a metal spoon in a refrigerator overnight. When she removed both spoons at the same time, the metal spoon felt colder than the plastic spoon.

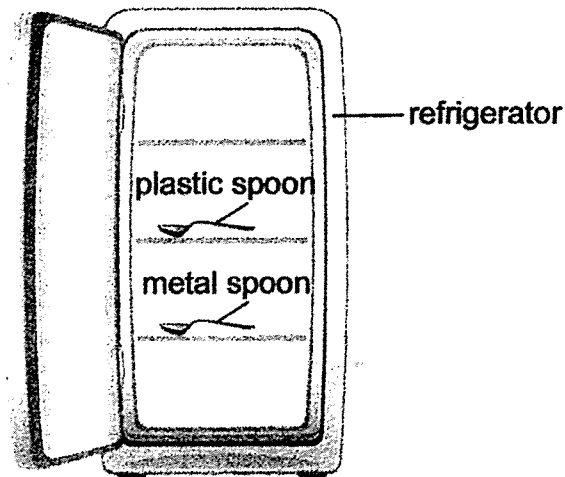

Which of the following explains why her hands felt that the metal spoon was colder than the plastic spoon?

- A The temperature of the metal spoon was lower than the plastic spoon.
- B Jill's hand lost heat to the metal spoon more quickly than to the plastic spoon.
- C The heat from the plastic spoon was conducted to Jill's hand more quickly.

- (1) B only
- (2) A and B only
- (3) B and C only
- (4) A, B and C

24. Don wanted to find out how the arrangement of bulbs in a circuit affects the brightness of the bulbs. Which variables should he keep the same for a fair experiment?

- A Number of bulbs
- B Brightness of bulbs
- C Number of batteries
- D Arrangement of bulbs

- (1) A and C only
- (2) B and D only
- (3) A, C and D only
- (4) A, B, C and D

25. The diagram below shows four bulbs, A, B, C and D, in a circuit that is connected correctly.

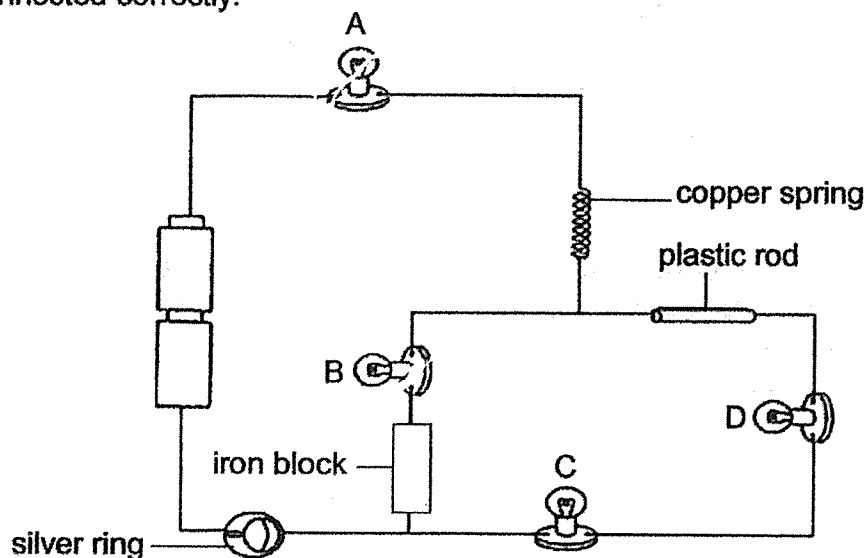

Which of the following bulbs will **not** light up?

- (1) A and B only
- (2) C and D only
- (3) A, C, D only
- (4) A, B, C and D

26. Identical batteries and bulbs are used to set up the circuit below.

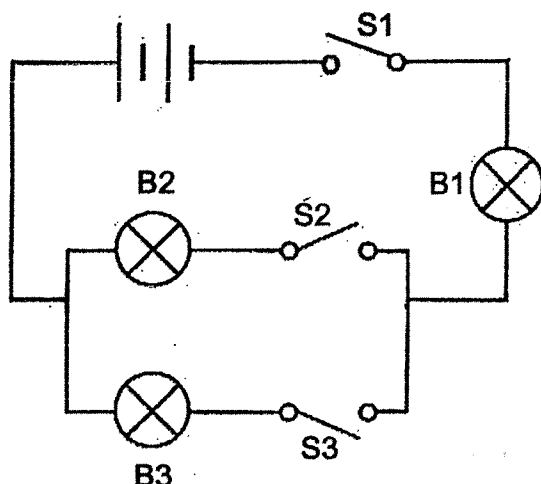

Which one of the following statements about the circuit is correct?

- (1) B1 will light up when either B2 or B3 is lighted.
 - (2) At least one bulb will light up when only S1 is closed.
 - (3) Electricity will flow through the circuit as long as one switch is closed.
 - (4) Electricity will flow through the circuit only when all the switches are closed.
27. June was trying to make a temporary magnet with a steel nail. She held a magnet on the N-pole and moved it up and down along the nail as shown by the arrows below.

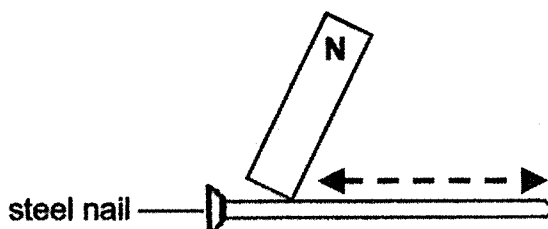

When she placed the steel nail near some pins, nothing happens. What could be the reason?

- (1) She used electricity to make the magnet.
- (2) She used a nail made of non-magnetic material.
- (3) She used the wrong pole of the magnet to stroke the nail.
- (4) She did not stroke the steel nail repeatedly in one direction.

28. Rina set up an experiment as shown below. When she released the car from Y, the car travelled down the track and then moved a short distance backwards before stopping at Z. The car did not touch object A at the end of the track.

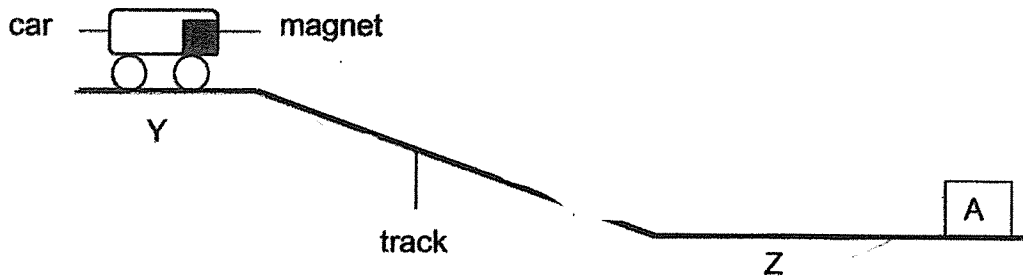

When she placed object B at the end of the track and released the car from Y, the car moved towards object B and was attached to it.

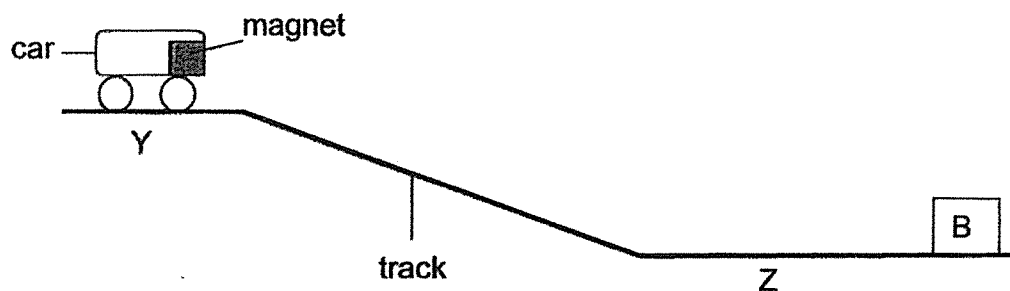

Based on the information above, what could objects A and B possibly be?

	A	B
(1)	iron block	plastic block
(2)	bar magnet	steel block
(3)	wooden block	iron block
(4)	electromagnet	copper block

Name: _____ Index No: _____ Class: P5 _____

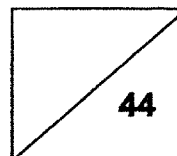

SECTION B (44 marks)

For questions 29 to 41, write your answers clearly in the spaces provided.

The number of marks is shown in brackets [] at the end of each question or part question.

29. The diagram below shows the various stages of process R taking place in the life cycle of a plant.

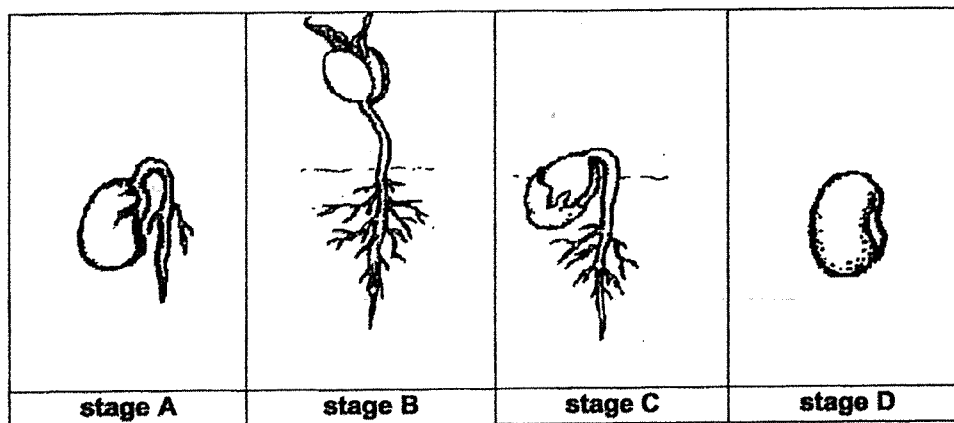

- (a) Name process R. [1]

- (b) Arrange the stages in the correct order of growth. [1]

_____ , _____ , _____ , _____

- (c) Put a tick (✓) in the boxes below for all the conditions needed for process R to take place. [1]

Conditions	tick (✓)
water	
sunlight	
air	
warmth	

Continue on next page

Score	3
-------	---

Continued from previous page

Cheryl prepared two identical plates containing an equal number of seeds. Each plate had an equal amount of cotton wool. The cotton wool in set-up Y was damp while the one in set-up Z was dry as shown in the diagrams below. Only set-up Y was watered daily.

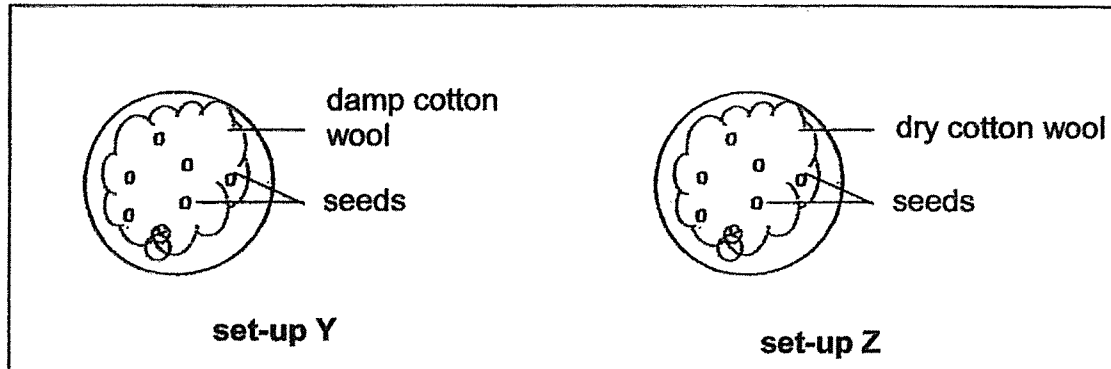

Cheryl placed both set-ups, Y and Z, in an enclosed cupboard for three weeks.

After three weeks, Cheryl noticed that young seedlings which developed in only one of the set-ups had died.

- (d) In which set-up did the young seedlings die at the end of the experiment? Explain your answer. [2]

Score	2
-------	---

30. Emily found a flower of plant M. She noticed that the reproductive parts of the flower were hidden in the flower as shown below.

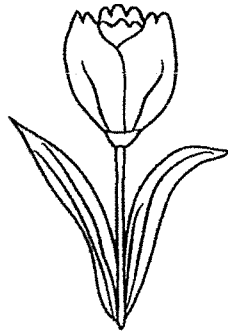

flower of plant M

- (a) In what way is this flower most likely to be pollinated by? [1]

- (b) She recorded her observations based on four characteristics of the flower of plant M in a table.

Circle the characteristics most likely to be present in the flower of plant M. [2]

	Characteristics	
Colour of flower	bright and colourful	dull and white
Size of petals	small	large
Smell of flower	no smell	strong smell
Texture of stigma	feathery	sticky

Score	3
-------	---

31. Mrs Lim wanted her students to find out if the roots of a plant took in water. She prepared two set-ups as shown below.

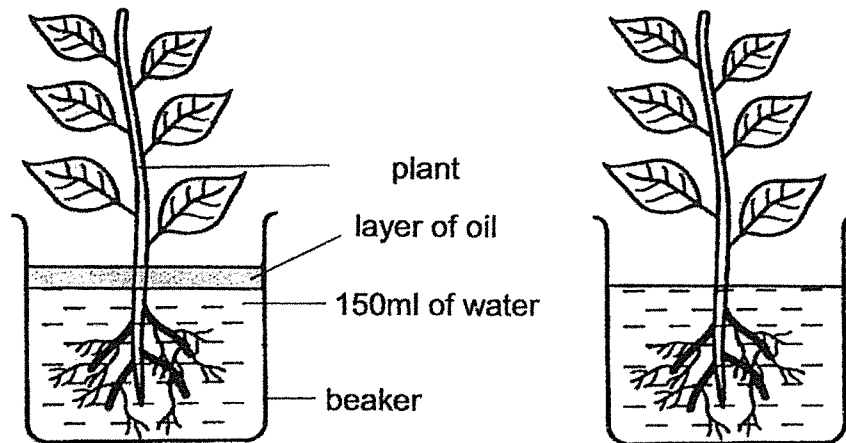

experimental set-up

incomplete control set-up

- (a) Without removing any part(s) of the plant in the incomplete control set-up, **draw and label in the diagram below two changes** that need to be made to the control set-up to complete it. [2]

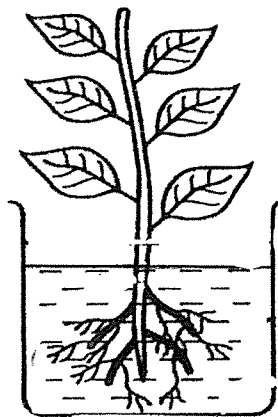

- (b) State the purpose of the completed control set-up in (a). [1]

Score	3
-------	---

32. The diagram below shows the human digestive system.

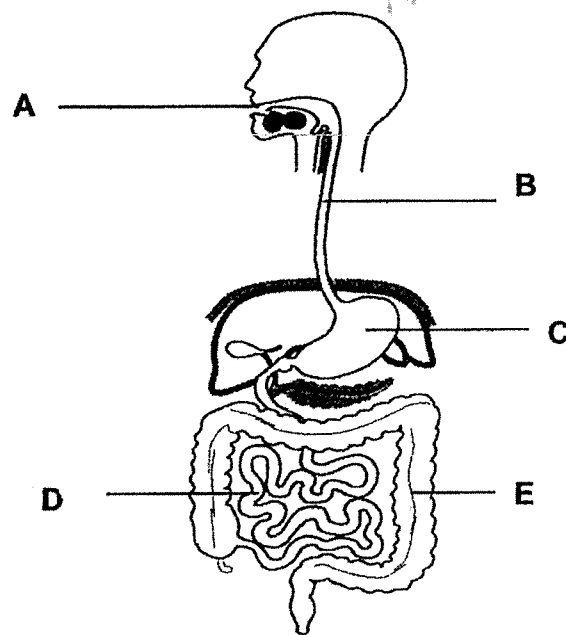

(a) **Circle** the correct letter in the diagram **above** that represents the part of the system where digestion is completed. [1]

(b) Describe how the human digestive system and circulatory system work together to provide energy needed by the body. [2]

(i) Human digestive system:

(ii) Human circulatory system:

Score	3
-------	---

33. The flow chart below shows the classification of cells.

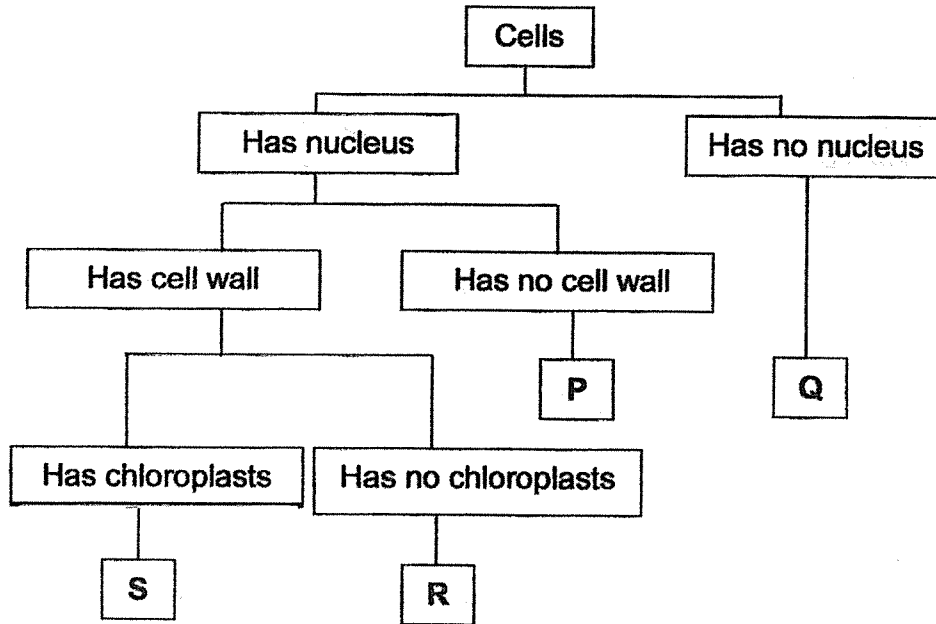

Based on the information above, answer the following questions.

(a) State one difference between cells Q and S. [1]

(b) Which cell, P, Q, R or S is likely to be a root cell? Give a reason for your answer. [1]

(c) A plant will not be able to survive if cell S is not present. Explain why. [1]

Score	3
-------	---

34. Sasha's training session consists of three main segments which are the warm-up, actual running and cool down. The graph below shows her heart rate during her training session.

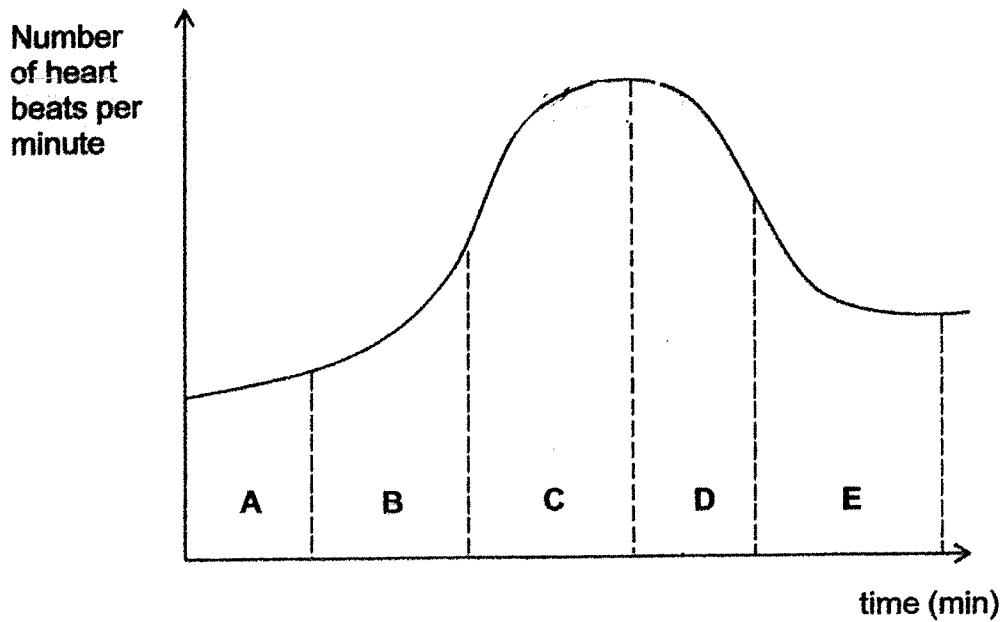

- (a) Which part of the graph best represents the change in Sasha's heart rate when she was running at the maximum speed?

Put a tick (✓) in the correct box.

[1]

Parts	Tick (✓)
A	
B	
C	
D	
E	

- (b) Based on the graph above, explain the increase in her heart rate from parts A to C.

[2]

Score	3
-------	---

35. The diagrams below show parts of the fish and the human respiratory systems.

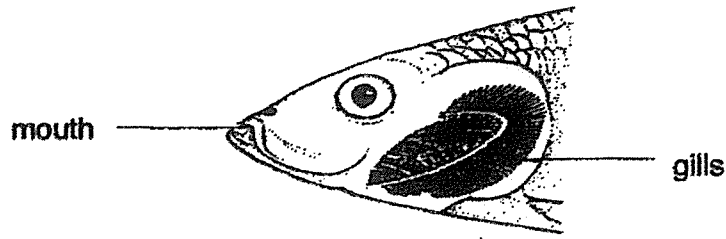

Fish respiratory system

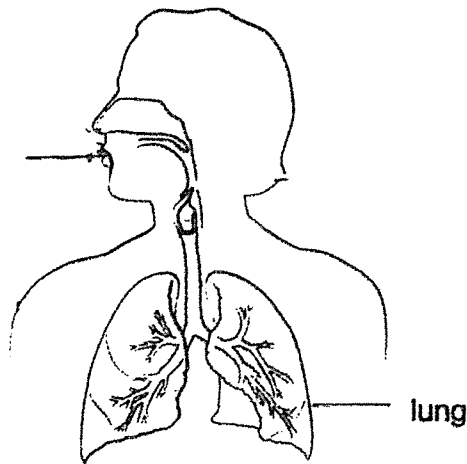

Human respiratory system

(a) Name the part where the gaseous exchange takes place in each of the respiratory system. [2]

(i) Fish respiratory system:

(ii) Human respiratory system:

(b) Explain how the increased exposed surface area of the part identified in (a)(i) helps the fish in terms of the gaseous exchange. [1]

Score	3
-------	---

36. The diagram below shows the movement of substances in parts of a plant.

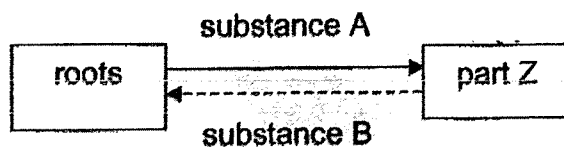

- (a) Gaseous exchange for the plant occurs through part Z. Identify part Z. [1]

Part Z: _____

- (b) What are substances A and B? [2]

Substance A: _____

Substance B: _____

Score	3
-------	---

36. The diagram below shows the movement of substances in parts of a plant.

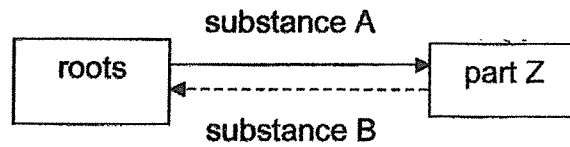

(a) Gaseous exchange for the plant occurs through part Z. Identify part Z. [1]

Part Z: _____

(b) What are substances A and B? [2]

Substance A: _____

Substance B: _____

Score	3
-------	---

37. The diagram shows parts of the stem which were cut and removed.

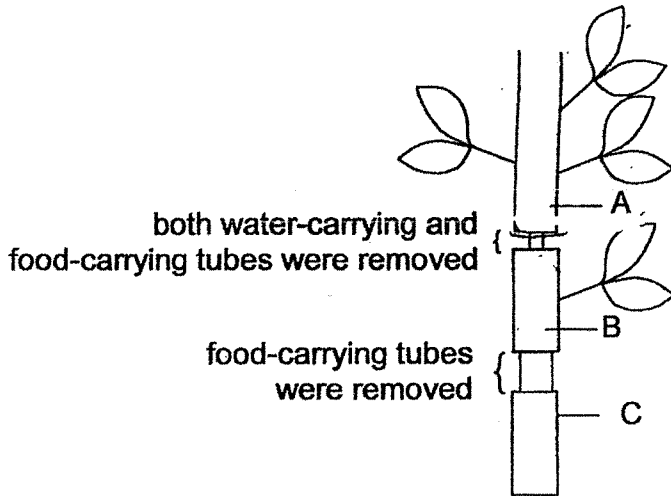

(a) After one week, it was observed that some leaves died. State the part (A, B or C) where the leaves died. Explain your answer. [2]

(b) After some time, observations were made at parts B and C of the stem. Put a tick(✓) below the correct diagram that shows the observation correctly. [1]

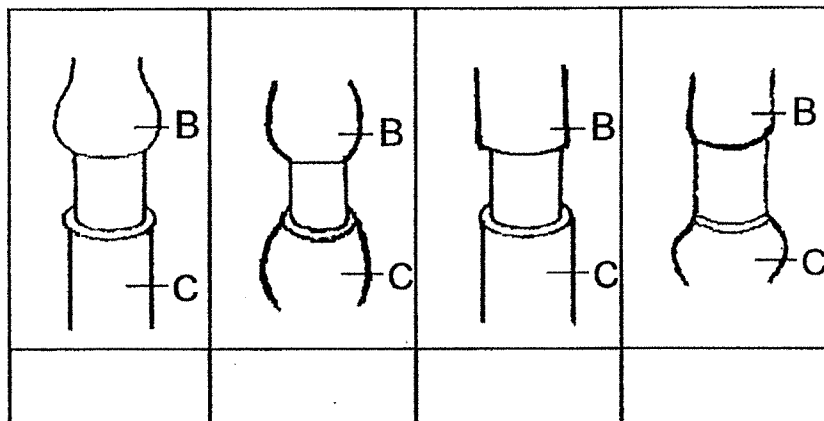

Score	3
-------	---

38. An ice cream cart has a freezer that stores ice cream for sale. Mist was seen when the ice cream man opened the freezer lid as shown below.

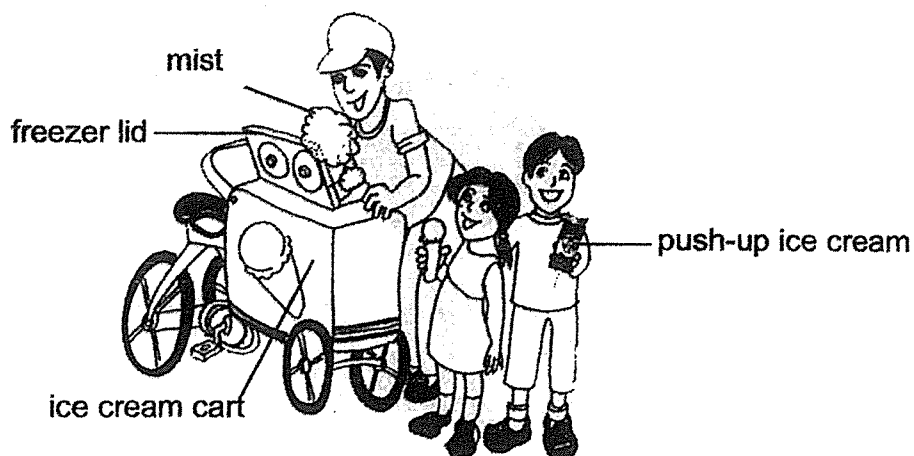

- (a) Explain how the mist was formed. [2]

- (b) The mist disappeared after a short while. Explain why. [1]

Two children bought an ice cream each. They observed that the ice cream inside the plastic cylinder, as shown below, remained frozen longer than the ice cream that was pushed up.

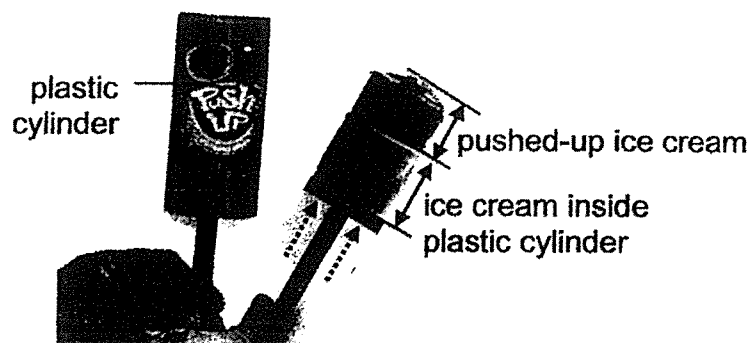

- (c) Explain why the ice cream inside the plastic cylinder remained frozen longer. [1]

Score	4
-------	---

39. Azim read a book with a face shield on, during the Covid-19 pandemic as shown below.

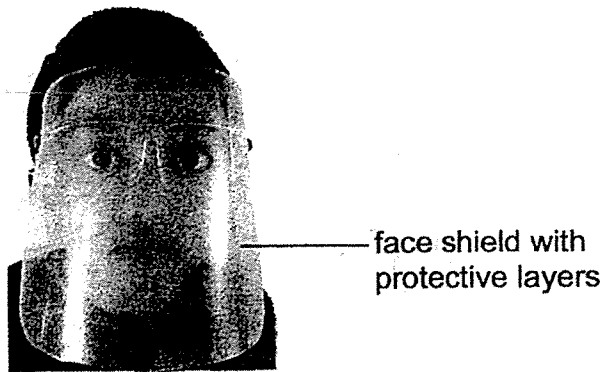

He complained that he could not read the words clearly even though he has perfect eyesight. He soon realised that he had not removed the top and bottom coloured protective layers on the shield.

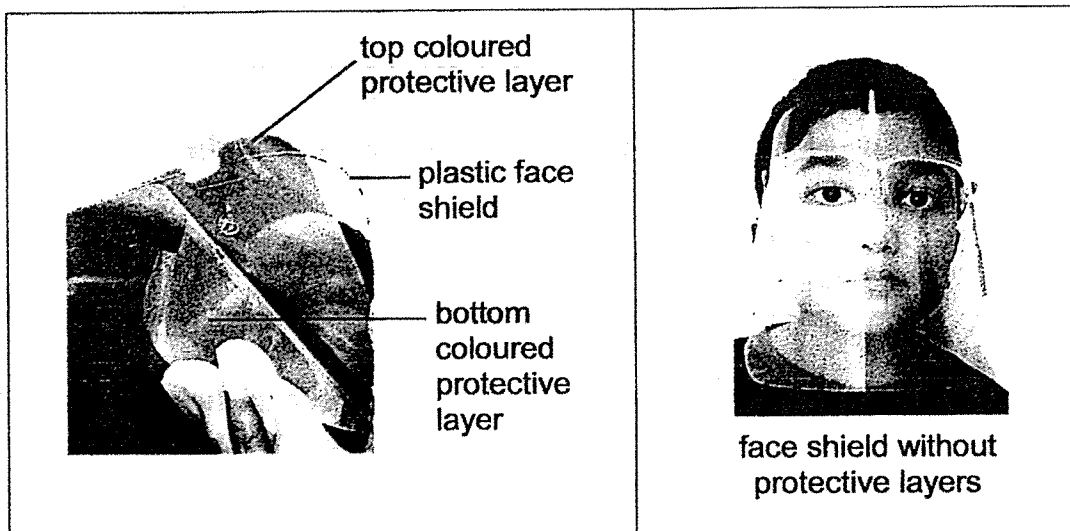

After removing the coloured protective layers on the shield, Azim could easily read his book.

- (a) Explain why Azim was **not** able to clearly see the words in his book at first. [1]

Continue on next page

Score	1
-------	---

Continued from previous page

Azim later climbed up many flights of stairs. His face felt hot and it took a longer time to cool down with the plastic face shield on than without it.

(b) Explain why Azim's face took a longer time to cool down. [2]

That evening, Azim was completing his online homework in a dark room as shown below.

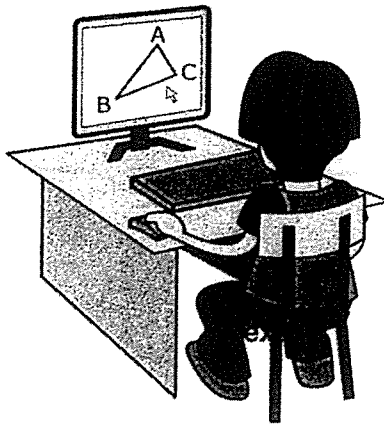

(c) Why was Azim able to see the computer screen in the dark? [1]

Score	3
-------	---

40. Jane prepared two set-ups, P and Q, using identical batteries and light bulbs as shown below.

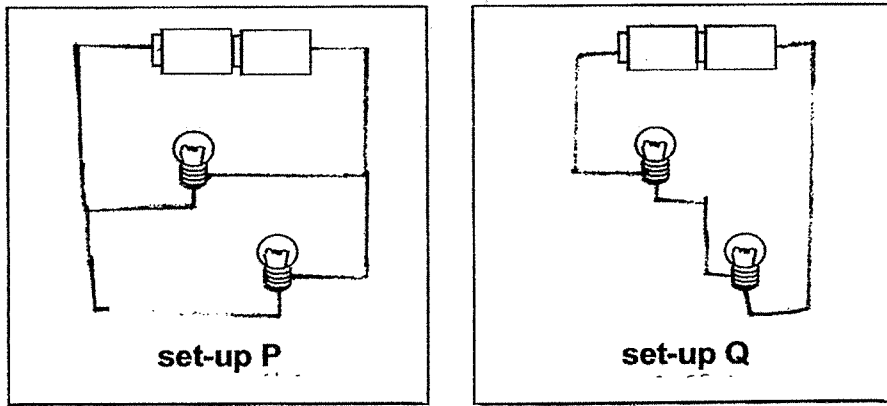

- (a) In the diagrams **above**, draw in the wires in each set-up such that the bulbs in set-up P will be brighter than the ones in set-up Q. [2]
- (b) Jane made another circuit Y and connected objects A, B and C to the circuit as shown below. All the bulbs and batteries were in working condition.

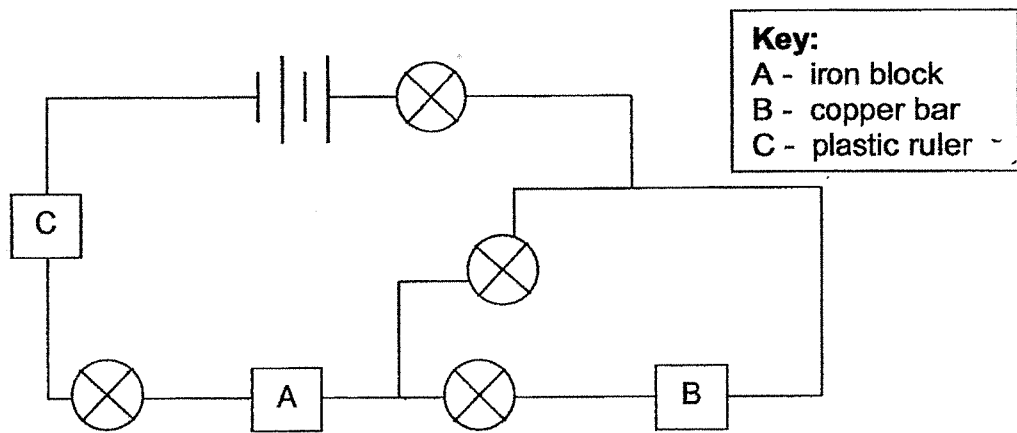

circuit Y

- (i) She observed that none of the bulbs in circuit Y lit up. Explain why. [1]

Continue on next page

Score	3
-------	---

Continued from previous page

- (ii) At which positions in the circuit below should Jane place objects A, B and C so that most number of bulbs could be lit?

Write A, B or C in each of the boxes provided below. Use each object ONCE only. [1]

Key:
A - iron block
B - copper bar
C - plastic ruler

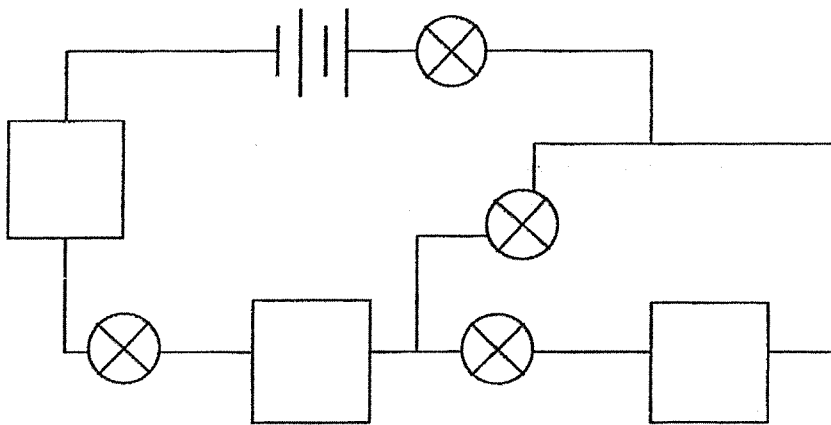

Score	1
-------	---

41. The diagram below shows a floating potted plant.

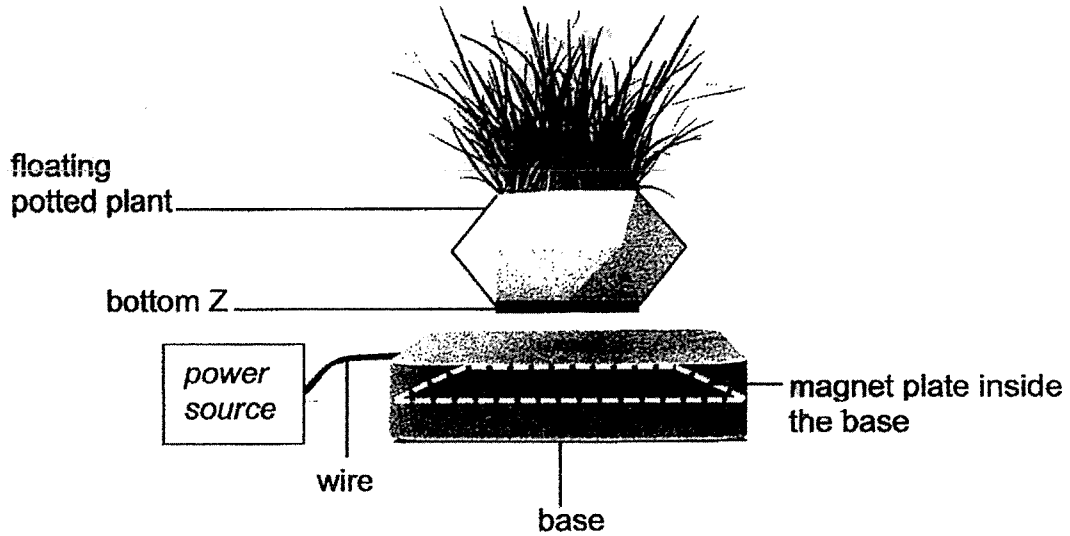

The floating potted plant consists of a base containing a magnet plate and a special bottom Z, as shown in the diagram above. Bottom Z must be present and the power source must be switched on for the potted plant to float.

- (a) Identify what bottom Z is. [1]

- (b) How does the object you have identified in (a) allow the potted plant to float above the base? [1]

- (c) Suggest a way that would allow a floating plant with a greater mass to stay afloat above the base. [1]

END OF PAPER

Score	3
-------	---

ANSWER KEY

YEAR : 2021
LEVEL : Primary 5
SCHOOL : Raffles Girls' Primary School
SUBJECT : SCIENCE
TERM : Practice Paper 3

BOOKLET A

Q1	3	Q2	4	Q3	2	Q4	3	Q5	4
Q6	3	Q7	2	Q8	2	Q9	4	Q10	3
Q11	3	Q12	4	Q13	3	Q14	4	Q15	1
Q16	3	Q17	1	Q18	3	Q19	1	Q20	4
Q21	1	Q22	3	Q23	1	Q24	1	Q25	2
Q26	1	Q27	4	Q28	2				

BOOKLET B

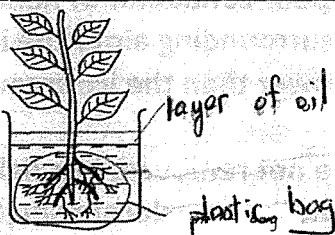
Q29	<p>(a) Germination</p> <p>(b) D,A,C,B</p> <p>(c) water, air, warmth</p> <p>(d) Set-up Y. the young seedlings with leaves did not receive sunlight as they were placed in an enclosed cupboard. Hence they were not able to make their own food in the absence of sunlight. Thus they withered and died.</p>
Q30	<p>(a) Animals</p> <p>(b) Bright and colourful, Large, Strong smell, sticky</p>
Q31	 <p>(a)</p> <p>(b) To compare and confirm that any change in the water level is solely due to the presence of roots absorbing water.</p>
Q32	<p>(a) D</p> <p>(b) (i) Digestive system helps to breakdown the food into simpler substances and absorbs the digested food into the blood stream.</p> <p>(ii) The circulatory system will transport the digested food into all parts of the body.</p>

Q33	<p>(a) Cell S has a nucleus but cell Q Does not. (b) Cell R. It has a cell wall but no chloroplasts present. (c) Without cell S, there will be no chloroplasts present in the plant. Chloroplasts contains chlorophyll for the plant to make its own food, without chloroplasts, theb plant will not be able to make its own food thus the plant cannot survive.</p>
Q34	<p>(a) C (b) In part A to C, the heart pumps faster to transport more oxygen and more digested food in the blood to the other part of the body to produce more energy for running.</p>
Q35	<p>(a)(i) Gills (ii) Lungs (b) The increase exposed surface area in contact with the oxygen in the water allows the fish to absorb more dissolved oxygen in water.</p>
Q36	<p>(a) Leaf (b) Substance A : Water and dissolved mineral salts Substanfce B : Food</p>
Q37	<p>(a) Leaves above A. The water carrying tubes below A were removed. water from the roots cannot be transported up. The leaves above A were not able to make food and hence the leaves died.</p> <div data-bbox="331 1059 730 1256" style="text-align: center;"> </div> <p>(b)</p>
Q38	<p>(a) The warmer vapour from the surrounding air came into contact with the cooler air that came out from the freezer and lose heat and condensed to form water droplets. (b) The mist gained heat from the warmer surrounding air and evaporated. (c) The plastic surrounding the ice cream is a poor conductor of heat , slowing down the heat transferred from the surrounding air to the ice cream hence causing the ice cream to melt slower than the ice cream exposed to the surrounding air.</p>
Q39	<p>(a) As the protective layers on the shield were not removed, less light that reflects off the words was able to pass through the translucent shield to enter his eyes causing him to not be able to see the words clearly. (b) Plastic is a poor heat conductor and will conduct the heat from the face to the cooler surrounding air outside the face shield more slowly. (c) the computer screen is a light source which reflects light into Azim's eyes thus he was able to see.</p>

Q40

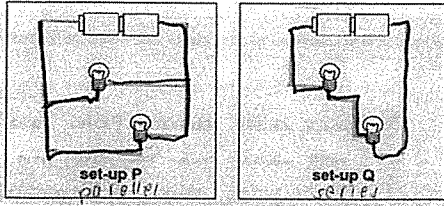

(a)

(b)(i) Object C is an insulator of electricity, hence it did not allow electric current to pass through the circuit to light up the bulbs.

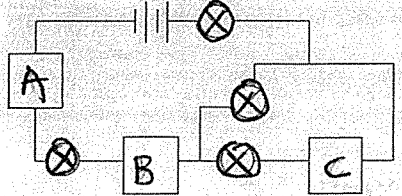

(ii)

Q41

(a) Magnet

(b) The like poles of the magnet placed at bottom Z and the magnet plate are facing each other causing the magnets to repel from each other to keep the potted plant afloat.

(c) use stronger magnets

3
END

599 15 107