

AS / CT / KANGYA / KYS / SL / TMY

SINGAPORE CHINESE GIRLS' SCHOOL
SECOND SEMESTRAL ASSESSMENT 2021

PRIMARY 5

MATHEMATICS
PAPER 1

BOOKLET A

Name : _____ ()

Class : Primary 5

Date : 28 October 2021

		Marks attained	Max Mark
Paper 1	Booklet A		20
	Booklet B		25
Paper 2			55
Total Marks			100

Parent's Signature

15 Questions
20 Marks

Total Time for Booklets A and B: 1 h

INSTRUCTIONS TO CANDIDATES

Do not open this booklet until you are told to do so.

Follow all instructions carefully.

Answer all questions.

You are not allowed to use a calculator

Booklet A

Questions 1 to 10 carry 1 mark each. Questions 11 to 15 carry 2 marks each.
For each question, four options are given. One of them is the correct answer.
Make your choice (1, 2, 3 or 4). Shade the correct oval (1, 2, 3 or 4) on the Optical Answer Sheet. **(20 marks)**

1. What does the digit 8 in 876 543 stand for?

- (1) 8 millions
- (2) 8 hundred thousands
- (3) 8 ten thousands
- (4) 8 thousands

2. Which of the following is equal to $4\frac{7}{8}$?

- (1) $\frac{28}{8}$
- (2) $\frac{36}{8}$
- (3) $\frac{39}{8}$
- (4) $\frac{60}{8}$

3. In the scale below, find the value of A.

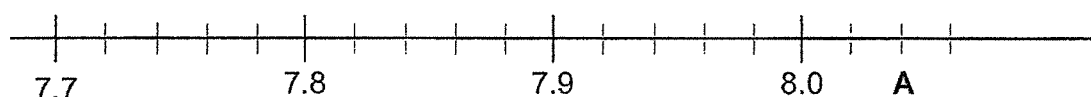

- (1) 8.2
- (2) 8.4
- (3) 8.02
- (4) 8.04

4. Round 5 794 643 to the nearest thousand.

(1) 5 790 000

(2) 5 794 000

(3) 5 795 000

(4) 5 800 000

5. Which of the following is likely to be the total mass of 2 apples?

(1) 2 g

(2) 20 g

(3) 200 g

(4) 2000 g

6. Which one of the following fractions is nearest to $\frac{3}{4}$?

(1) $\frac{1}{2}$

(2) $\frac{5}{6}$

(3) $\frac{5}{8}$

(4) $\frac{7}{12}$

7. $92\,750 \div 1000 =$ _____

(1) 9275

(2) 927.5

(3) 92.75

(4) 9.275

8. Express 85% as a decimal.

- (1) 85
- (2) 8.5
- (3) 0.85
- (4) 0.085

9. PQ and RS are straight lines. Which of the following is true?

- (1) $\angle b = \angle e$
- (2) $\angle a = \angle c$
- (3) $\angle b + \angle c + \angle d = 180^\circ$
- (4) $\angle a + \angle c = 180^\circ$

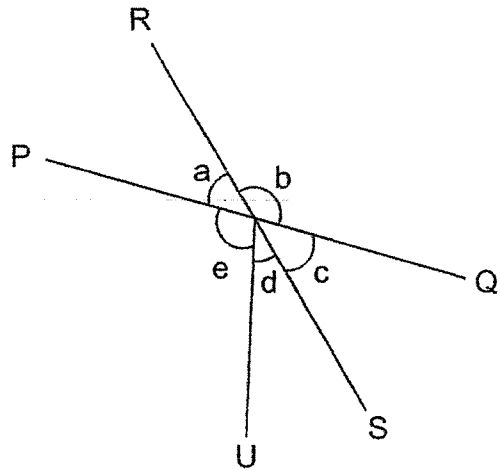

10. Which of the following is the same as 8070 g ?

- (1) 8.07 kg
- (2) 8.7 kg
- (3) 80.07 kg
- (4) 80.7 kg

11. Mr Wong bought 5 kg of noodles. He used $\frac{1}{5}$ of it to cook Mee Goreng and $\frac{1}{5}$ kg to cook Mee Soto. How much noodles did Mr Wong have left?

(1) $4\frac{3}{5}$ kg

(2) $3\frac{1}{5}$ kg

(3) 3 kg

(4) $3\frac{4}{5}$ kg

12. Mrs Chandra baked 45 cupcakes. 27 were almond cupcakes and the rest were chocolate cupcakes. What is the ratio of the number of almond cupcakes to chocolate cupcakes?

(1) 2 : 3

(2) 3 : 2

(3) 3 : 5

(4) 5 : 3

13. 1000 people who attended a concert. 600 were adults and 100 were boys. What percentage of the audience were girls?

(1) 10 %

(2) 20 %

(3) 30 %

(4) 40 %

14. Janice is half the age of her father. Her father is 48 years old now. What is the ratio of Janice's age to her father's age in 8 years' time?

- (1) 1 : 2
- (2) 3 : 2
- (3) 3 : 7
- (4) 4 : 7

15. In the figure below, $AB = BC$ and BCD is a straight line. Find $\angle ACD$.

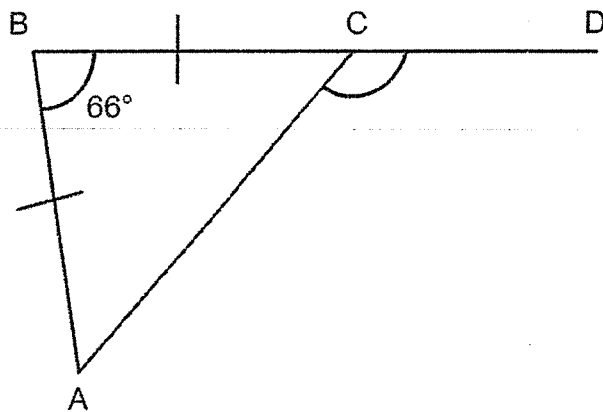

- (1) 57°
- (2) 114°
- (3) 123°
- (4) 130°

End of Booklet A

AS / CT / KANGYA

SINGAPORE CHINESE GIRLS' SCHOOL
SECOND SEMESTRAL ASSESSMENT 2021

PRIMARY 5

MATHEMATICS
PAPER 1

BOOKLET B

Name : _____ ()

Class : Primary 5 SY

Date : 28 October 2021

Paper 1	Mark attained	Max Mark
Booklet B		25

15 Questions

25 Marks

Total Time for Booklets A and B: 1 h

INSTRUCTIONS TO CANDIDATES

Do not open this booklet until you are told to do so.

Follow all instructions carefully.

Answer all questions.

You are not allowed to use a calculator

Booklet B

Do not write in
this column

Questions 16 to 20 carry 1 mark each. Write your answers in the spaces provided.
For questions which require units, give your answers in the units stated. (5 marks)

16. In an online game, 30 gems cost \$15. Find the cost of each gem.

Ans: \$ _____

17. How much water is in the container?

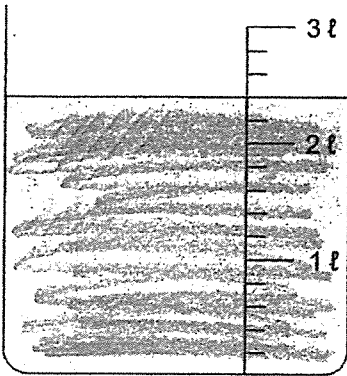

Ans: _____ ℓ

18. Find the value of $6 + 24 \div (11 - 8) \times 2$.

Ans: _____

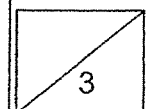

19. Arrange these numbers from the largest to the smallest.

0.081, 0.801, 0.81

Do not write in
this column

Ans: _____ , _____ , _____
(largest) (smallest)

20. Convert $\frac{7}{8}$ into a decimal.

Ans: _____

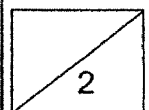

Questions 21 to 30 carry 2 marks each. Show your working clearly and write your answers in the spaces provided. For questions which require units, give your answers in the units stated. (20 marks)

Do not write in this column

21. How many more cubes are needed to fill up the tank below?

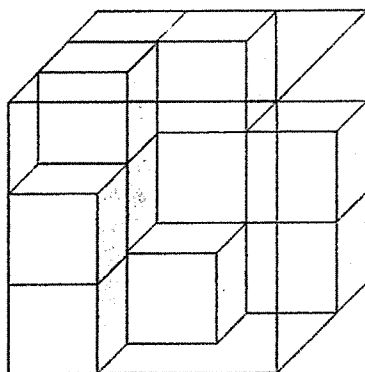

Ans: _____

22. Devi spent 30% of her salary and saves $\frac{7}{10}$ of the remainder. What percentage of her salary did she save?

Ans: _____ %

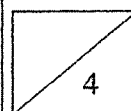

23. 5 boys shared 3 l of orange juice equally. How much of orange juice will each boy receive?

Do not write in this column

Ans: _____ l

24. In the triangle MOQ,

a) name the base and height of the triangle MOQ.

b) find the area of triangle MOQ.

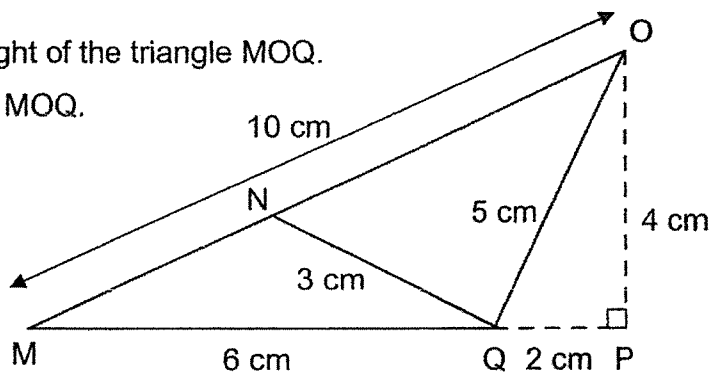

Ans: a) Base: _____

Height: _____

b) _____ cm^2

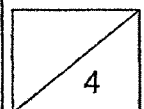

25. There are 5 tennis players. Each player will have one match against each of the other 4 players. How many different matches are there to be arranged?

Do not write in this column

Ans: _____

26. How many 4 cm by 4 cm squares can be cut out from a rectangular piece of paper measuring 39 cm by 52 cm?

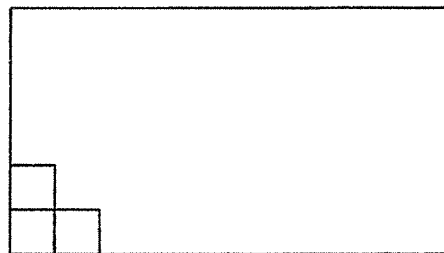

Ans: _____

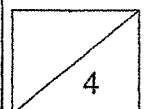

27. The mass of a honeydew is 6 times as heavy as the mass of a mango.

A lemon is $\frac{1}{2}$ the mass of the mango. The mass of the honeydew is 1100 g heavier than the mass of the lemon. What is the total mass of the 3 fruits?

Ans: _____ g

28. A machine operated from 6.15 a.m. to 9.45 p.m. How long was its operating time? Give your answer in hours and minutes.

Ans: ____ h ____ min

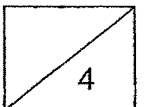

29. Draw the top and side view of the solid below.

Do not write in
this column

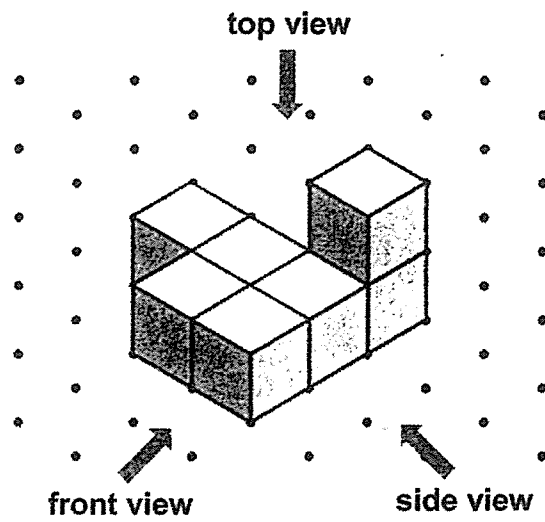

Top View

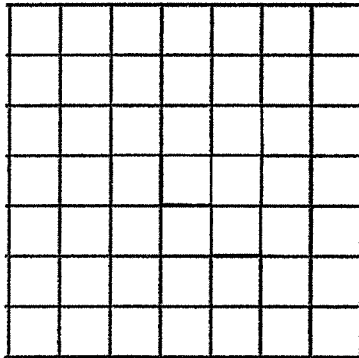

Side View

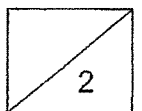
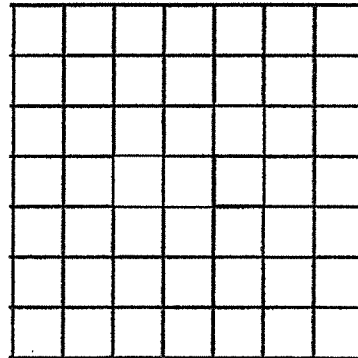

Do not write in
this column

30. Mr Wen bought some stickers for his students. If he gives each of his students 5 stickers, he will have 1 sticker left. If he gives each of them 2 stickers, he will have 97 left. How many students does Mr Wen have?

Ans: _____

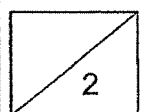

End of Booklet B

AS / CT / KANGYA

SINGAPORE CHINESE GIRLS' SCHOOL
SECOND SEMESTRAL ASSESSMENT 2021
PRIMARY 5
MATHEMATICS
PAPER 2

Name : _____ ()

Class : Primary 5

Date : 28 October 2021

	Mark	Max Mark
Paper 2		55

Parent's Signature

17 Questions
55 Marks

Total Time for Paper 2: 1 h 30 min

INSTRUCTIONS TO CANDIDATES

Do not open this booklet until you are told to do so.
Follow all instructions carefully.
Answer all questions.

Questions 1 to 5 carry 2 marks each. Show your working clearly in the space below each question and write your answers in the space provided. For questions which require units, give your answers in the units stated. (10 marks)

Do not write in this column

1. The price of a laptop was \$1690. Mdm Kaur bought the laptop and had to pay an additional 7% GST. Find the GST amount she has to pay.

Ans: \$ _____

2. The diagram below is not drawn to scale. Given that RST and QSP are straight lines and QRS is an isosceles triangle, find $\angle a$.

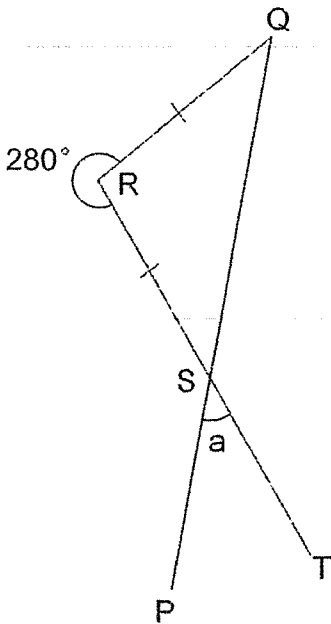

Ans: _____ °

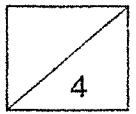

Do not write in
this column

3. Yue Ling weighs 52 kg. Aralyn weighs 12 kg lighter than Yue Ling. Prisha weighs 6 kg heavier than Aralyn. What is the ratio of Yue Ling's mass to Aralyn's mass to Prisha's mass? (Give your answer in the simplest form.)

Ans: _____

4. The numbers 1 to 200 were written on a piece of paper which was torn. Which row is number 188 in?

A	1	8	15	
B	2	9	16	
C	3	10	17	
D	4	11	18	
E	5	12	19	
F	6	13	20	
G	7	14		

Ans: _____

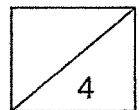

Do not write in this column

5. Mr Tan decorated a noticeboard using squares. The squares were placed at the same distance apart. The distance between the second and the sixth square was 74 cm. ^{The length of} Each square was 10 cm. What is the distance between the first and tenth square?

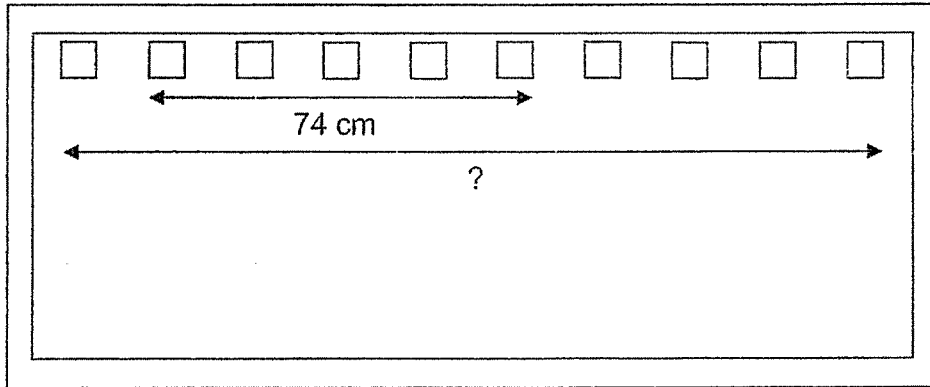

Ans: _____ cm

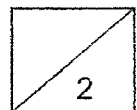

For questions 6 to 17, show your working clearly in the space below each question and write your answers in the spaces provided. The number of marks awarded is shown in brackets [] at the end of each question or part-question. **(50 marks)**

Do not write in
this column

6. Lucas collected 60 cards more than Mary. When Lucas gave 70 cards to Mary, Mary had thrice the number of cards Lucas had. How many cards did Lucas have at first?

Ans: _____ [3]

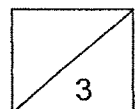

7. The figure below, not drawn to scale, is made up of identical small squares and big squares. The length of the small and big squares are 10 cm and 20 cm respectively. Find the area of the shaded parts.

Do not write in this column

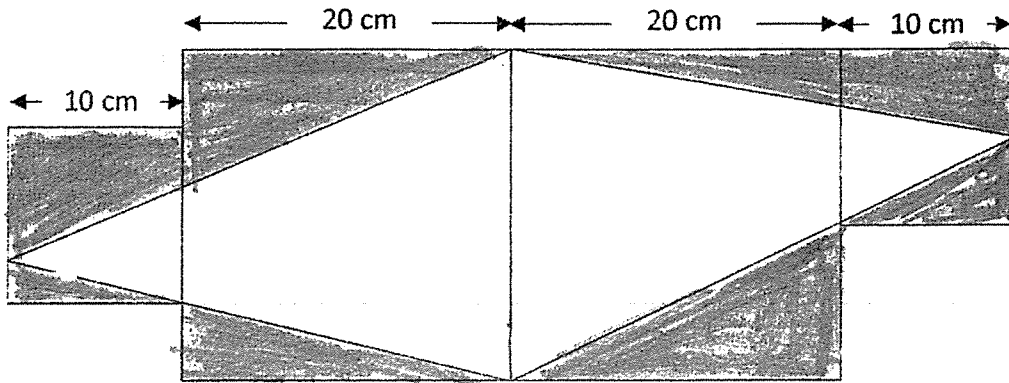

Ans: _____ [3]

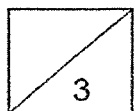

8. Donuts are sold at 80¢ each or in a box of 12 for \$8.80. What is the least amount of money needed to buy 100 donuts?

Do not write in this column

Ans: _____ [3]

9. Siti has the same number of 50-cent coins and 20-cent coins. The total value of the coins is \$8.40. How many coins does she have altogether?

Ans: _____ [3]

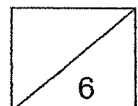

10. A room can hold either 45 adults or 75 children. If there are already 25 children and 8 adults in the room, how many more adults can the room hold?

Do not write in
this column

Ans: _____ [3]

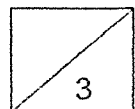

Do not write in
this column

11. Peter spent $\frac{7}{12}$ of his savings and an additional \$6 on durians. He then spent $\frac{1}{4}$ of his remaining money and an additional \$2 on mangosteens. If he had \$16 left, how much did he spend on durians?

Ans: _____ [5]

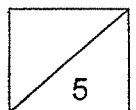

12. The diagram below is not drawn to scale.
 A rectangular piece of paper is folded to form the diagram below.
 a) Find $\angle a$.
 b) Find $\angle b$.

Do not write in
 this column

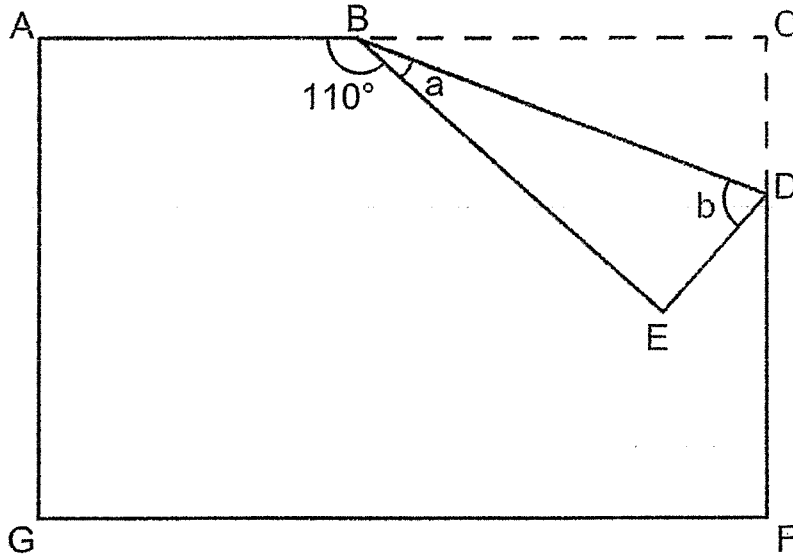

Ans: (a) _____ [2]

(b) _____ [2]

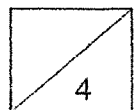

13. Miss Koh baked 250 more strawberry cookies than chocolate cookies. She sold 70% of the strawberry cookies and 20% of the chocolate cookies. In the end, she had the same number of strawberry cookies and chocolate cookies left. Find the number of chocolate cookies she baked at first.

Do not write in
this column

Ans: _____ [4]

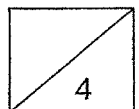

Do not write in this column

14. The tank below, measuring 21 cm by 20 cm by 40 cm, is $\frac{3}{4}$ filled with water at first. All the water is poured into empty identical bottles to the brim. Each bottle has a capacity of 700 ml.
- a) How much water was there in the tank at first?
 - b) How many such bottles are completely filled with water?

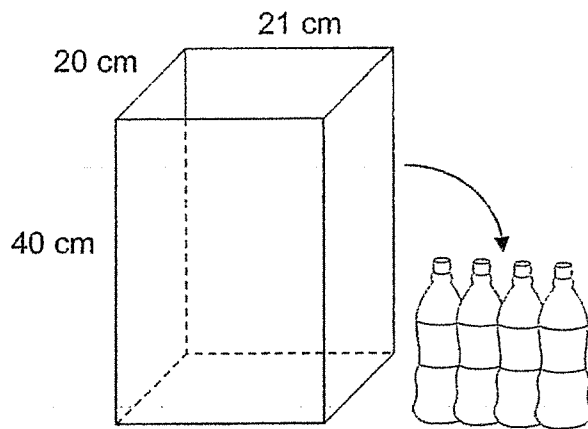

Ans: (a) _____ [2]

(b) _____ [2]

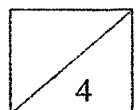

Do not write in
this column

15. In a fruit store, 28% of the fruits were apples and the rest were oranges and pears. The number of oranges is 3 times the number of pears. There were 324 oranges.

- a) What percentage of the fruits were pears?
- b) How many apples were there?

Ans: (a) _____ [1]

(b) _____ [3]

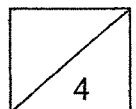

Do not write in
this column

16. The figure shown below is made up of a rectangle and a square. The area of the square is $\frac{3}{5}$ of the area of the rectangle. The unshaded part of the square is $\frac{2}{5}$ of the area of the unshaded part of the rectangle. Given that the shaded area is 45 cm^2 , what is the area of the figure?

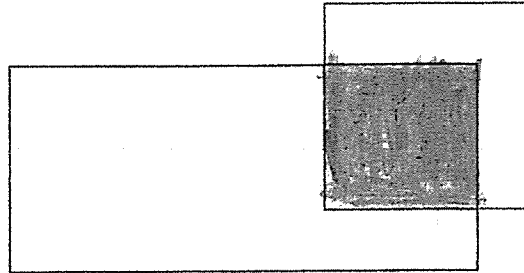

Ans: _____ [4]

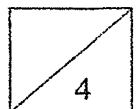

17. During a trivia quiz, points were awarded for questions answered as shown below.

Correct	5 points
Wrong	- 2 points
Missed	- 1 points

The ratio of the questions answered correctly to questions answered wrongly to questions that were missed out was $9 : 2 : 1$. If Janice was awarded 360 points, how many questions are there in all?

Do not write in
this column

Ans: _____ [5]

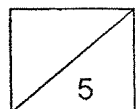

End of Paper 2
~ Please check your work thoroughly. ~

ANSWER KEY

YEAR : 2021
LEVEL : Primary 5
SCHOOL : Singapore Chinese Girls' School
SUBJECT : MATHEMATICS
TERM : Second Semestral Assessment

BOOKLET A (PAPER 1)

Q1	2	Q2	3	Q3	4	Q4	3	Q5	3
Q6	2	Q7	3	Q8	3	Q9	2	Q10	1
Q11	4	Q12	2	Q13	3	Q14	4	Q15	3

BOOKLET B (PAPER 1)

Q16	$15 \div 30 = 0.50$	Q17	2.4
Q18	22	Q19	0.81, 0.801, 0.081
Q20	0.875	Q21	13
Q22	$\frac{7}{10} \times 70 = 49$	Q23	$3 \div 5 = 0.6$
Q24	(a) Base : MQ Height : OP (b) $\frac{1}{2} \times 6 \times 4 = 12$	Q25	10
Q26	$39 \div 4 = 9.75$ $52 \div 4 = 13$ $13 \times 9 = 117$	Q27	$100 \times 15 = 1500$
Q28	15h 30 min	Q29	<div style="display: flex; justify-content: space-around; align-items: center;"> <div style="text-align: center;"> <p>Top View</p> </div> <div style="text-align: center;"> <p>Side View</p> </div> </div>
Q30	32		

Worked Solutions & eMCQ available at www.sgtestpaper.com

PAPER 2

Q1	$\frac{7}{100} \times 1690 = 118.30$	Q2	$360 - 280 = 80$ $(180 - 80) \div 2 = 50$
Q3	$52 - 12 = 40$ $40 + 6 = 46$	Q4	$\frac{188}{7} = 26R6$ Ans: F

	Y: A : P 52: 40 : 46 26: 20: 23		
Q5	$10 \times 5 = 50$ $74 - 50 = 24$ $24 \div 4 = 6$ $6 \times 9 = 54$ $10 \times 10 = 100$ $100 + 54 = 154$	Q6	$70 + 10 = 80$ $80 \div 2 = 40$ $40 + 70 = 110$
Q7	$\frac{1}{2} \times 30 \times 20 = 300$ $300 \times 2 = 600$ $(2 \times 10 \times 10) + (2 \times 20 \times 20) = 1000$ $1000 - 600 = 400 \text{cm}^2$	Q8	$100 \div 12 = 8R4$ $8 \times 8.80 = 70.40$ $0.80 \times 4 = 3.20$ $70.40 + 3.20 = \$73.60$
Q9	$50 + 20 = 70$ $\frac{8.40}{0.70} = 12$ $12 \times 2 = 24$	Q10	$15A = 25C$ $45 - 15 - 8 = 22$
Q11	$16 + 2 = 18$ $\frac{18}{3} = 6$ $6 \times 4 = 24$ $24 + 6 = 30$ $30 \div 5 = 6$ $6 \times 7 = 42$ $42 + 6 = \$48$	Q12	(a) $(180 - 110) \div 2 = 35^\circ$ (b) $90 - 35 = 55^\circ$
Q13	$100\% - 70\% = 30\%$ $100\% - 20\% = 80\%$ $40 - 15 = 25$ $250 \div 25 = 10$ $10 \times 15 = 150$	Q14	(a) $(\frac{3}{4} \times 40) \times 20 \times 21 = 12600 \text{ml}$ (b) $12600 \div 700 = 18$
Q15	(a) $(100\% - 28\%) \div 4 = 18\%$ (b) $18 \times 3 = 54$ $\frac{324}{54} = 6$ $28 \times 6 = 168$	Q16	$\frac{45}{5} = 9$ $9 \times 19 = 171 \text{cm}^2$
Q17	C : W : M 9 : 2 : 1 $(5 \times 9) - (2 \times 2) - (1 \times 1) = 40$ $\frac{360}{40} = 9$ $9 \times 12 = 108$		