

CATHOLIC HIGH SCHOOL
END-OF-YEAR EXAMINATION (2021)
PRIMARY FIVE
MATHEMATICS
PAPER 1
(BOOKLET A)

Name : _____ ()

Class : Primary 5 _____

Date : 27 October 2021

Total time for Booklet A and B : 1 h

15 questions

20 marks

Parent's signature : _____

INSTRUCTIONS TO CANDIDATES

Do not turn over this page until you are told to do so.

Follow all instructions carefully.

Answer all questions.

Shade your answers in the Optical Answer Sheet (OAS) provided.

The use of calculators is **NOT** allowed.

Booklet A and B consist of 13 printed pages excluding the cover page.

Questions 1 to 10 carry 1 mark each. Questions 11 to 15 carry 2 marks each. For each question, four options are given. One of them is the correct answer. Make your choice (1, 2, 3 or 4). Shade the oval (1, 2, 3 or 4) on the Optical Answer Sheet. All diagrams are not drawn to scale. (20 marks)

1. Which of the following is three million, four hundred thousand and twenty in numerals?

- (1) 3 000 420
 - (2) 3 100 420
 - (3) 3 400 020
 - (4) 3 401 020
-

2. Find the value of $48\,000 \div 200$

- (1) 24
 - (2) 240
 - (3) 2400
 - (4) 24 000
-

3. Which of the following is the same as 10 m 5 cm?

- (1) 105 cm
 - (2) 150 cm
 - (3) 1005 cm
 - (4) 1050 cm
-

4. Express 0.08 as a percentage.

- (1) 8%
 - (2) 0.8%
 - (3) 80%
 - (4) 800%
-

5. Express $6\frac{1}{7}$ as an improper fraction.

(1) $\frac{13}{7}$

(2) $\frac{42}{7}$

(3) $\frac{43}{6}$

(4) $\frac{43}{7}$

6. Find the volume of a cube of edge 4 cm.

(1) 12 cm^3

(2) 16 cm^3

(3) 32 cm^3

(4) 64 cm^3

7. Line AB and CD are straight lines. $\angle AOD = 120^\circ$ and $\angle BOE = 95^\circ$. Find $\angle x$.

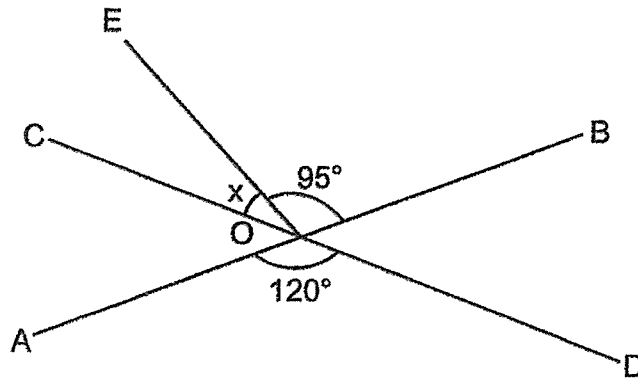

- (1) 25°
(2) 35°
(3) 60°
(4) 85°
-

8. There are 100 coloured balls. 55 of the balls are purple and the rest are yellow. What is the ratio of the number of purple balls to the number of yellow balls? Express your answer in its simplest form.

- (1) 9 : 11
(2) 9 : 20
(3) 11 : 9
(4) 11 : 20
-

9. A container can hold $\frac{1}{5}$ kg of flour. How many kilograms of flour can 9 such containers hold?

(1) $1\frac{4}{5}$ kg

(2) $9\frac{1}{5}$ kg

(3) 14 kg

(4) 4 kg

10. In the figure below, given that EA is the height of Triangle EBC, which is the base of Triangle EBC?

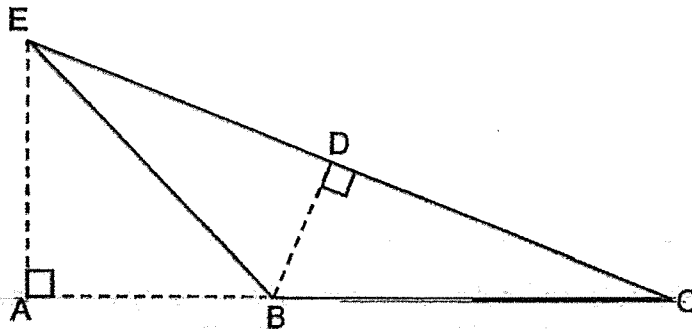

(1) AC

(2) BC

(3) EC

(4) BD

11. The ratio of the number of Economy Class seats to the number of Premium Class seats in an aeroplane is 5 : 3. There are 112 more Economy Class seats than Premium Class seats. How many Economy Class seats and Premium Class seats are there altogether in the aeroplane?

(1) 56

(2) 168

(3) 280

(4) 448

12. Julien had \$300. He spent 30% of his money on a bag and 10% of his money on a pouch. How much money did he spend in all?

- (1) \$40
 - (2) \$90
 - (3) \$120
 - (4) \$180
-

13. ABCD is a rectangle. Point E lies on line AB. AE is 4 cm. EB is 8 cm. Find the area of the shaded triangle.

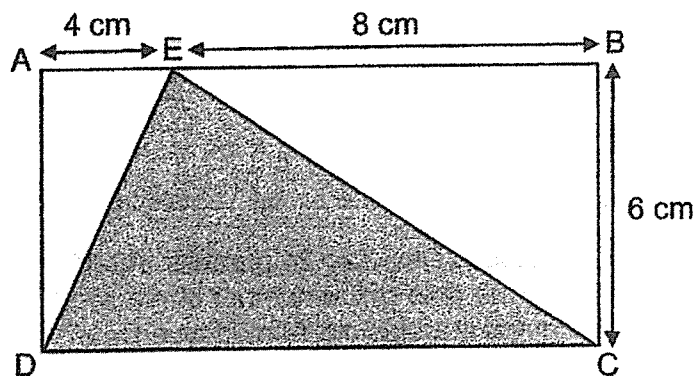

- (1) 12 cm^2
 - (2) 36 cm^2
 - (3) 48 cm^2
 - (4) 72 cm^2
-

14. Jerry wanted to build a wooden fence around his rectangular field as shown below. Each metre of fence cost \$12. How much would it cost him to build a fence around his rectangular field?

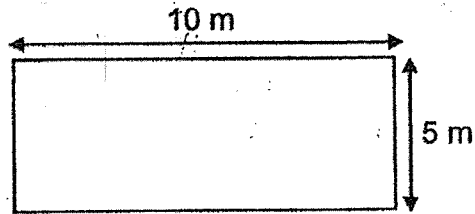

- (1) \$120
(2) \$180
(3) \$360
(4) \$600
-
15. Ahmad had 16 marbles and Devi had 24 marbles. After Ahmad gave some of his marbles to Devi, the ratio of the number of marbles Ahmad and Devi had was 1 : 3. How many marbles did Ahmad give Devi?
- (1) 6
(2) 8
(3) 10
(4) 4

END OF BOOKLET A

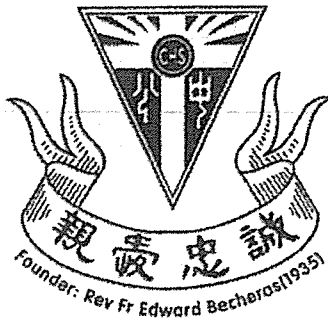

CATHOLIC HIGH SCHOOL
END-OF-YEAR EXAMINATION (2021)
PRIMARY FIVE
MATHEMATICS
PAPER 1
(BOOKLET B)

Name : _____ ()

Class : Primary 5 _____

Date : 27 October 2021

Total time for Booklet A and B : 1 h

15 questions

25 marks

Parent's signature : _____

BOOKLET A	20
BOOKLET B	25
Total Marks	45

INSTRUCTIONS TO CANDIDATES

Do not turn over this page until you are told to do so.

Follow all instructions carefully.

Answer all questions.

Shade your answers in the Optical Answer Sheet (OAS) provided.

The use of calculators is **NOT** allowed.

Booklet A and B consist of 13 printed pages excluding the cover page.

Questions 16 to 20 carry 1 mark each. Write your answers in the spaces provided. For questions which require units, give your answers in the units stated. All diagrams are not drawn to scale. (5 marks)

Do not write in this space

16. The solid shown below is formed using some unit cubes. How many unit cubes are used to form the solid?

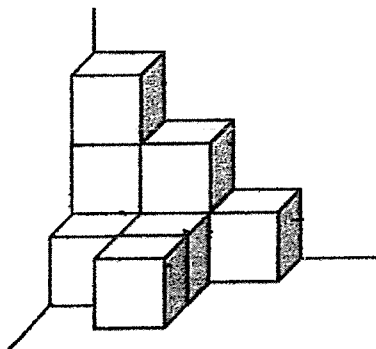

Ans: _____

17. Find the value of $16 \times 4 - 5 + 10$

Ans: _____

18. Express 6.06 l in cubic centimetres.

Ans: _____ cm^3

19. Express $3\frac{1}{20}$ as a decimal.

Do not write
in this space

Ans: _____

20. Find the value of 7.6×80

Ans: _____

Total marks for questions 16 to 20

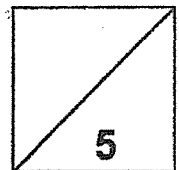

Questions 21 to 30 carry 2 marks each. Show your working clearly and write your answers in the spaces provided. For questions which require units, give your answers in the units stated. All diagrams are not drawn to scale.

(20 marks)

Do not write
in this space

21. Find the value of $13 \div 7$. Give your answer to 2 decimal places.

Ans: _____

22. What is the missing number in the blank?

$$14 : 21 = \underline{\hspace{2cm}} : 9$$

Ans: _____

23. $\frac{2}{7}$ of a garden was planted with roses. $\frac{1}{3}$ of the roses were white and the rest of the roses were red. What fraction of the garden was planted with red roses?

Ans: _____

24. The figure below is made up of 9 identical small squares and 1 big square. What percentage of the figure is shaded?

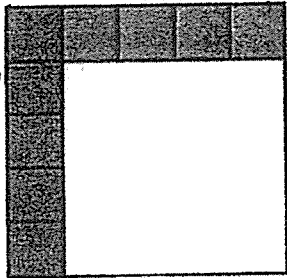

Do not write
in this space

Ans: _____ %

25. The figure below shows a right-angled triangle. Find $\angle x$.

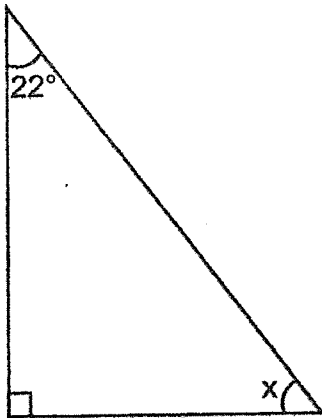

Ans: _____ °

26. Figure A is a right-angled triangle. What is the maximum number of Figure A that can be cut out from the rectangle as shown below?

Do not write in this space

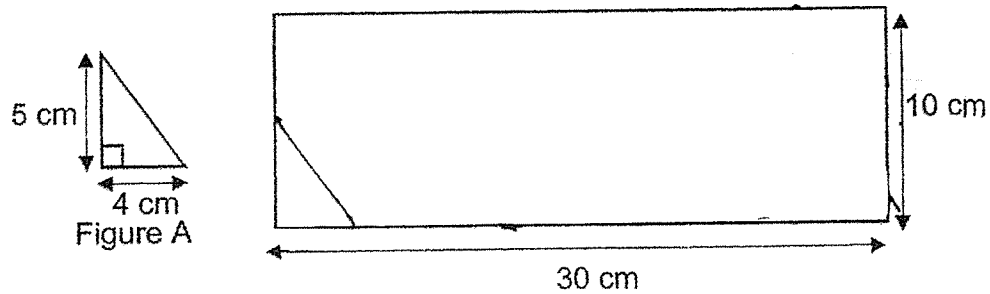

Ans: _____

27. The table below shows the charges for a taxi ride.

First 1 km	\$3.10
Every additional 500 m or less	\$0.30

Gary took a taxi from his office to his home. The distance from his office to his home is 2.1 km. How much did he pay for the taxi ride?

Ans: \$ _____

28. In the figure below, $\angle k = 42^\circ$. $\angle m$ is thrice that of $\angle k$. Find $\angle j$.

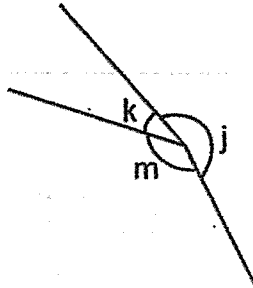

Do not write
in this space

Ans: _____^o

29. Meng En spent \$120 of his savings on a watch and $\frac{1}{3}$ of his remaining money on a book. He had $\frac{1}{2}$ of his savings left. How much was his savings at first?

Ans: \$ _____

30. This year, the ratio of John's age to Mary's age is 3 : 5. Mary is 6 years older than John.

Do not write
in this space

Each of the statements below is either true, false or not possible to tell from the information given. For each statement, put a tick (✓) to indicate your answer.

	Statement	True	False	Not possible to tell
(a)	In 3 years' time, Mary will be 9 years older than John.			
(b)	Next year, the total age of John and Mary is 26 years old.			

Total marks for questions 21 to 30

END OF BOOKLET B
END OF PAPER 1

20

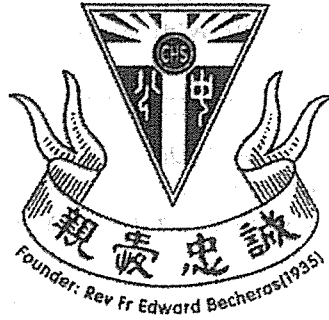

CATHOLIC HIGH SCHOOL
END-OF-YEAR EXAMINATION (2021)
PRIMARY FIVE
MATHEMATICS
PAPER 2

Name : _____ ()

Class : Primary 5 _____

Date : 27 October 2021

Total time : 1 h 30 min

17 questions

55 marks

Parent's signature : _____

PAPER 1 BOOKLET A	20
PAPER 1 BOOKLET B	25
PAPER 2	55
Total Marks	100

INSTRUCTIONS TO CANDIDATES

Do not turn over this page until you are told to do so.

Follow all instructions carefully.

Answer all questions.

Write your answers in this booklet.

The use of an approved calculator is expected, where appropriate.

This booklet consists of 15 printed pages excluding the cover page.

Questions 1 to 5 carry 2 marks each. Show your working clearly in the space below each question and write your answers in the spaces provided. For questions which require units, give your answers in the units stated. All diagrams are not drawn to scale. (10 marks)

Do not write in this space

1. Suranti had \$90 000 in her bank account. The bank paid 3.5% interest at the end of the year. She did not withdraw any of her savings for the year. How much money did she have at the end of the year?

Ans: \$ _____

2. Mrs Lim bought $5\frac{1}{5}$ kg of meat. She used some meat to make a meat pie and had $3\frac{1}{2}$ kg of meat left. How much meat did she use to make the meat pie?

Ans: _____ kg

3. A rectangular piece of paper was folded along line ZW as shown below. $\angle WZY$ is 73° . Find $\angle b$.

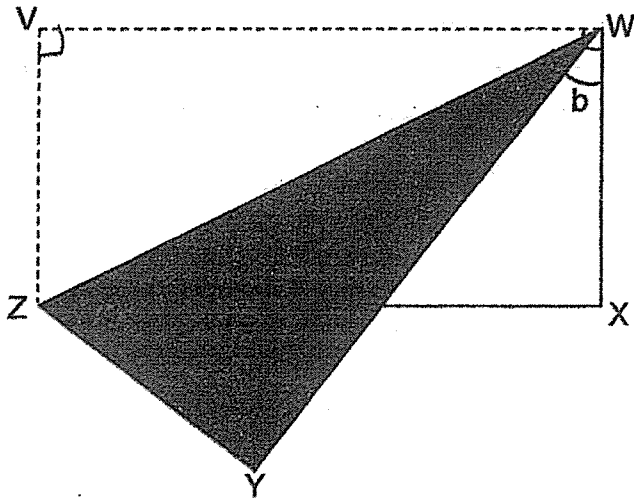

Do not write
in this space

Ans: _____ °

4. The figure below shows 8 identical rectangles arranged differently in 2 stacks. Find the breadth of a rectangle.

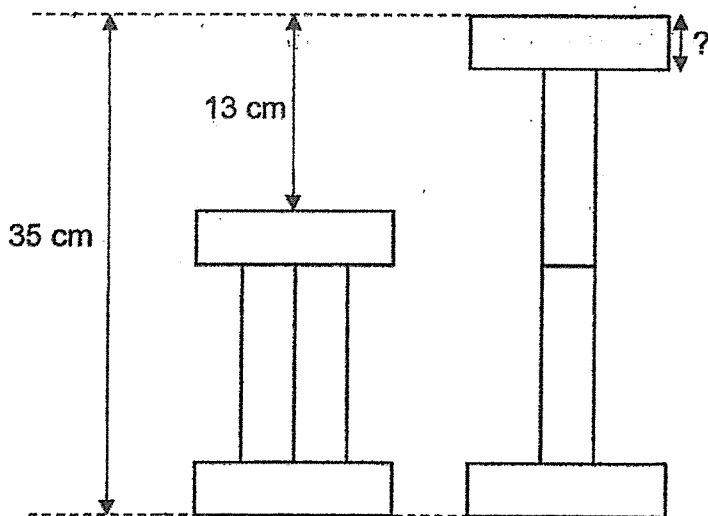

Ans: _____ cm

5. The following solid is made up of 8 cubes. Draw the top view and the front view of the solid.

Do not write in this space

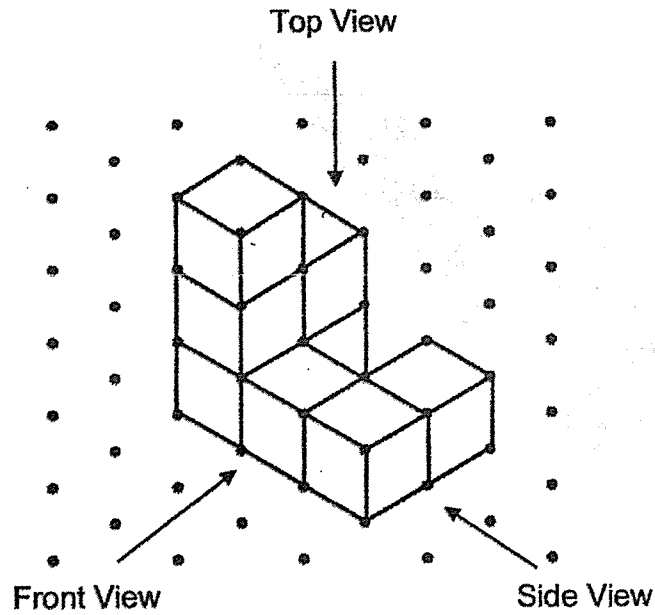

Top View

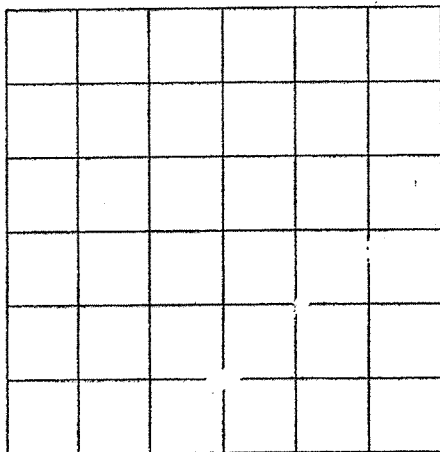

Front View

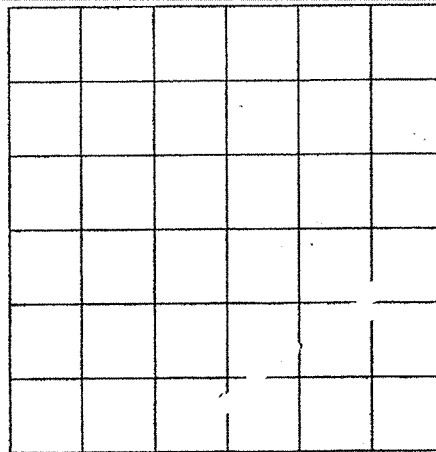

For questions 6 to 17, show your working clearly in the space provided for each question and write your answers in the spaces provided. The number of marks available is shown in brackets [] at the end of each question or part-question. (45 marks)

Do not write
in this space

6. Florence had 80 more stamps than Mandy. After Florence gave 95 stamps to Mandy, Mandy had twice as many stamps as Florence. How many stamps did Florence have at first?

Ans: _____ [3]



7. A group of 3 boys and 8 girls went to a party. Each boy received the same number of candies and each girl was given 2 more candies than each boy. The group received a total of 82 candies. How many candies did each boy receive?

Do not write
in this space

Ans: _____ [3]

8. The figure ABCD shown below is made up of an equilateral triangle ABD and an isosceles triangle BCD. $\angle ABC = 148^\circ$. Find $\angle BCD$.

Do not write
in this space

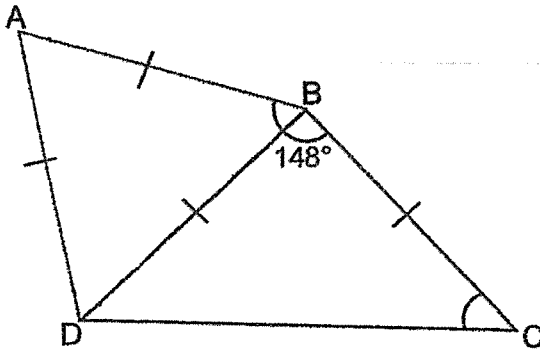

Ans: _____ [3]



9. Alan and Ben had \$2145 in total. After Alan spent $\frac{6}{7}$ of his money and Ben spent $\frac{1}{5}$ of his money, they had an equal amount of money left. How much money did each of them have left?

Do not write
in this space

Ans: _____ [3]



10. 7 identical pairs of shorts cost the same as 11 identical T-shirts. Each pair of shorts cost \$3.80 more than each T-shirt. What was the cost of a pair of shorts?

Do not write
in this space

Ans: _____ [3]

11. X and Y are two rectangular containers. Container X is filled with water as shown in the diagram below. Container Y is empty. All the water from Container X is poured into Container Y, without spilling. In the end, Container Y is $\frac{5}{6}$ -filled with water.

Do not write
in this space

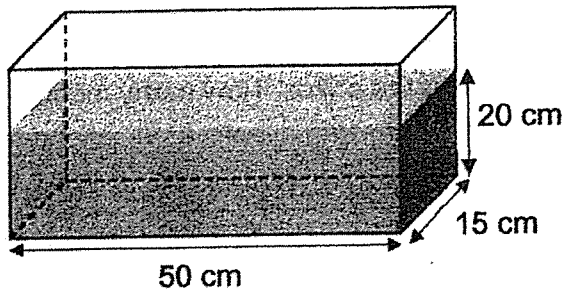

Container X

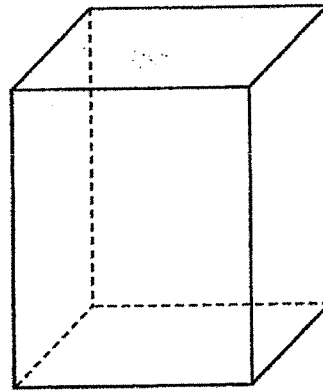

Container Y

- (a) What is the volume of water in Container X?
(b) What is the capacity of Container Y?

Ans: (a) _____ [2]

(b) _____ [2]

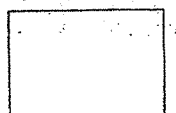

12. The ratio of the number of small prizes to medium prizes to large prizes bought for a lucky draw was 8 : 3 : 1. The table below shows the cost of the different prizes.

Do not write
in this space

Prizes	Costs of each prize
Small prize	\$2
Medium prize	\$5
Large Prize	\$10

A total of \$1066 was spent on buying the prizes. How many medium prizes were there in the lucky draw?

Ans: _____ [4]



13. The line graph shows the number of bottles of water sealed over 10 minutes.

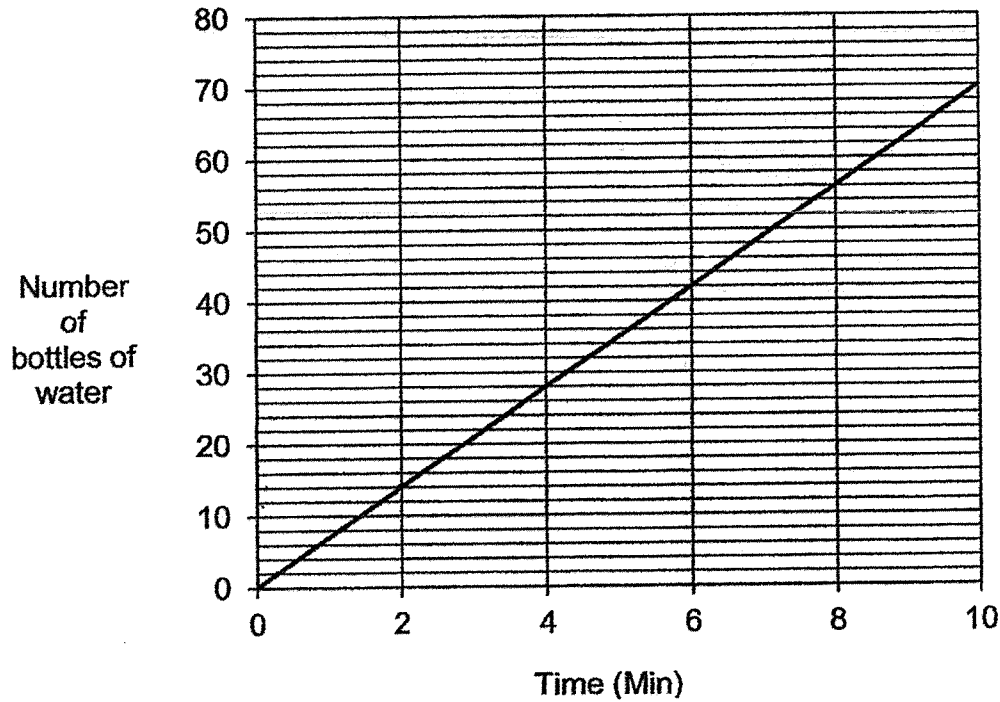

- (a) How many bottles of water were sealed in 1 minute?
- (b) At this rate, how many minutes would it take to seal 140 bottles of water?

Ans: (a) _____ [2]

(b) _____ [2]



14. Kelly and Laura had savings of \$150. Laura and Joseph had savings of \$180. Joseph had 3 times as much savings as Kelly.

Do not write
in this space

(a) How much savings did Kelly have?

(b) Laura and Kelly continued to save on top of what they already had. They did not spend their money. Both of them started saving from the same day. Laura saved \$5 a day and Kelly saved \$9 a day. How many days would it take for their savings to be the same?

Ans: (a) _____ [2]

(b) _____ [2]

15. A baker baked some muffins in the morning. He sold $\frac{1}{4}$ of his muffins in the morning. He sold $\frac{4}{7}$ of his remaining muffins in the afternoon and the rest of his muffins in the evening. He sold each muffin at \$2 and he collected \$144 from the evening sales of his muffins.

- (a) How many muffins did he sell in the evening?
- (b) How many muffins did he bake?

Do not write
in this space

Ans: (a) _____ [2]

(b) _____ [3]

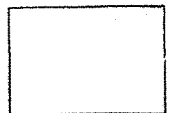

16. An egg seller had 2070 eggs. 20% of the eggs broke during delivery. He threw the broken eggs away and packed the rest of the eggs in cartons. Each carton contained either 6 or 12 eggs. He packed 181 cartons of eggs.

Do not write
in this space

- (a) How many eggs were packed in cartons?
- (b) How many cartons of eggs contained 6 eggs?

Ans: (a) _____ [2]

(b) _____ [3]



17. The first four figures of a pattern are shown below.

Do not write
in this space



Figure 1

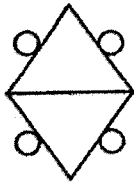

Figure 2

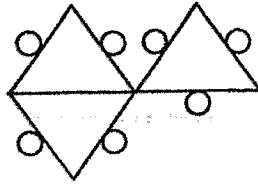

Figure 3

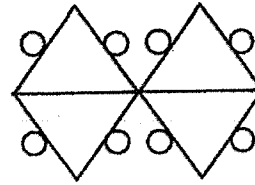

Figure 4

The table below shows the number of triangles and circles used for each figure.

Figure Number	Number of triangles	Number of circles	Total number of triangles and circles
1	1	3	4
2	2	4	6
3	3	7	10
4	4	8	12
5			16

[2]

- (a) Complete the table for Figure 5.
 (b) Find the total number of triangles and circles for Figure 15.

Ans: (b) _____ [2]



END OF PAPER 2

ANSWER KEY

YEAR : 2021
LEVEL : PRIMARY 5
SCHOOL : CATHOLIC HIGH SCHOOL
SUBJECT : MATHEMATICS
TERM : END OF YEAR EXAMINATION

PAPER 1

Q1	3	Q2	2	Q3	3	Q4	1	Q5	4
Q6	4	Q7	1	Q8	3	Q9	1	Q10	2
Q11	4	Q12	3	Q13	2	Q14	3	Q15	1

Q16	9
Q17	$64 - 5 + 10$ $59 + 10$ 69
Q18	6.06×1000 $= 6060 \text{ cm}^3$
Q19	$3\frac{1}{2} = 3\frac{3}{100} = 3.05$
Q20	$7.6 \times 8 \times 10$ $= 60.8 \times 10$ $= 608$
Q21	1.86
Q22	6
Q23	$\frac{4}{21}$
Q24	$\frac{9}{25} \times 100 = 36\%$
Q25	$90^\circ - 22^\circ = 68^\circ$
Q26	$30 \div 4 = 7$ sets of r.2cm $7 \times 4 = 28$
Q27	$\$0.30 \times 3 = \0.90 $\$3.10 + \$0.90 = \$4$
Q28	$360^\circ - 42^\circ - 126^\circ = 192^\circ$
Q29	$\frac{4}{12} \times 120 = \frac{1}{2}$ $1u = 120$ $4u = \$480$
Q30	a) False <input checked="" type="checkbox"/>
	b) True <input checked="" type="checkbox"/>

Worked Solutions & eMCQ available at www.sgtestpaper.com

PAPER 2

Q1	$\frac{90000}{100} \times \frac{103.5}{1} = 93150$
Q2	$5\frac{1}{5} - 3\frac{1}{2} = 1\frac{7}{10}$ =1.7kg
Q3	$180^\circ - 73^\circ - 90^\circ = 17^\circ$ $180^\circ - 73^\circ - 90^\circ = 17^\circ$ $90^\circ - 17^\circ - 17^\circ = 56^\circ$
Q4	4.5cm
Q5	<div style="display: flex; justify-content: space-around; align-items: center;"> <div style="text-align: center;"> <p>Top View</p> </div> <div style="text-align: center;"> <p>Front View</p> </div> </div>
Q6	$95 + 15 = 110$ $1u \rightarrow 110$ $F \rightarrow 110 + 15 + 80 = 205$ Florence had 205 stamps at first
Q7	$2 \times 8 = 16$ $11u + 82 - 16 = 66$ $1u \rightarrow 66 \div 11 = 6$ Each boy received 6 candies
Q8	$148^\circ - 60^\circ = 88^\circ$ $(180 - 88^\circ) \div 2 = 46^\circ$
Q9	$\frac{1}{7}$ of Alan = $\frac{4}{5}$ of Ben $\frac{7}{7}$ of Alan = $\frac{28}{5}$ of Ben $2145 \rightarrow 28u + 5u \text{ Ben} = 2145 + 32$ $4u + \frac{2145}{33} \times \frac{4}{1} = 260$ Each of them have \$260 left
Q10	$3.8 \times 7 = 26.6$ $11.7 = 4$ 4 T-shirt = \$26.6 1 T-shirt \rightarrow \$26.6 \div 4 = \$6.65 1 Shirt \rightarrow \$6.65 + \$3.80 = \$10.45 1 pair of shorts cost \$10.45
Q11	a) vol. of water in Container X = $50 \times 15 \times 20$ = 15000ml
	b) $\frac{1}{6} \rightarrow 15000 \div 5 = 3000$ $\frac{6}{6} \rightarrow 3000 \times 6 = 18000 \text{cm}^3$
Q12	$1066 \div 41 = 28$ $26 \times 3 = 78$ 78 medium prizes were there in the lucky draw

Q13	a)	$14 \div 2 = 7$ 7 bottles of water were sealed in 1 minute.
	b)	$140 \div 7 = 20$ It would take 20 minutes to seal 140 bottles of water.
Q14		$2u \Rightarrow \$30$ $1u \Rightarrow 30 \div 2 = 15$ $\$150 - \$15 = \$135$ $\$135 - \$15 = \$120$ $\$9 - \$5 = \$4$ $120 \div 4 = 30$ a) \$15 b) \$30
Q15		$144 \div 2 = 72$ $\frac{1}{7}$ of R = $72 \div 3 = 24$ $R = 24 \times 7 = 168$ $\frac{3}{4}$ of muffin = 168 $\frac{1}{4}$ of muffin = $168 \div 3 = 56$ $56 \times 4 = 224$ a) 72 b) 224
Q16	a)	$80\% \Rightarrow \frac{2020}{100} \times 80 = 1656$ 1656 eggs were packed in cartons
	b)	$181 \times 2 = 2172$ $2172 - 108 = 516$ $12 - 6 = 6$ $516 \div 6 = 86$
Q17	a)	5,11
	b)	46