

Wing-Lo-Chinese School (Junior)



PRIMARY 4 SCIENCE BOOKLET A

Wednesday

1 hr 45 min

Name: _____ () Class: 4.()

INSTRUCTIONS TO PUPILS

- 1 Do not turn over the pages until you are told to do so.
- 2 Follow all instructions carefully.
- 3 There are 28 questions in this booklet.
- 4 Answer ALL questions.
- 5 Shade your answers in the Optical Answer Sheet (OAS) provided.

For each question from 1 to 28, four options are given. One of them is the correct answer. Make your choice (1, 2, 3 or 4) and shade your answer on the Optical Answer Sheet.

(56 marks)

1. The diagram shows a plant.

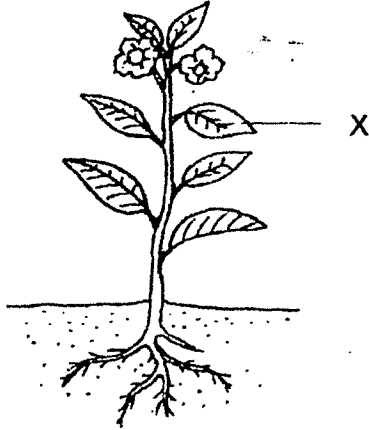

Which one of the following is a function of X on the plant?

- (1) makes food
 - (2) takes in water
 - (3) holds plant upright
 - (4) takes in mineral salts
2. Sam made the following observations on the life cycle of an animal.
- There are three stages in the life cycle.
 - The young looks like the adult.

Which animal was Sam observing?

- (1) Frog
- (2) Beetle
- (3) Butterfly
- (4) Chicken

3. The table shows how some living things can be grouped. The diagrams are not drawn to scale.

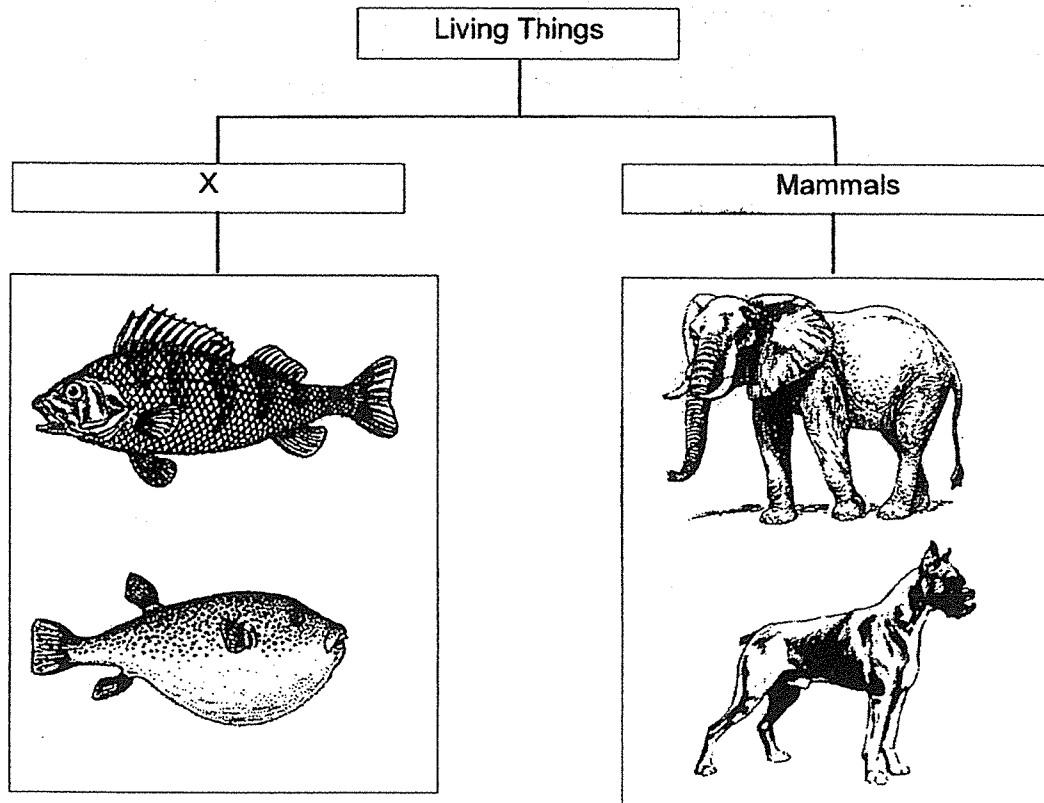

Which one of the following is the most suitable heading for group X?

- (1) Fish
- (2) Insects
- (3) Bacteria
- (4) Reptiles

4. Elijah placed a solid ball made of metal into a container of water.

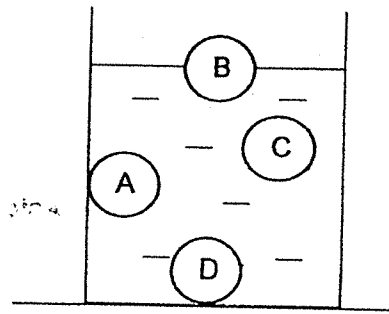

At which position, A, B, C or D, would the ball most likely to be found?

- (1) A
 - (2) B
 - (3) C
 - (4) D
5. The diagram shows the stages in the life cycle of a plant.

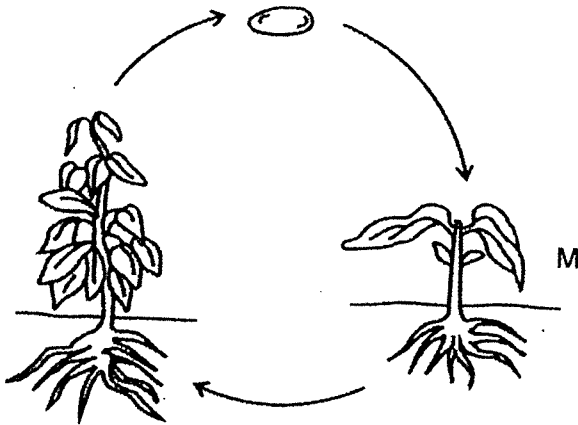

What is the stage marked M?

- (1) adult
- (2) seed
- (3) adult plant
- (4) young plant

6. Which one of the following shows the correct order when food moves through some parts of the digestive system?

- (1) stomach → large intestine → small intestine
 (2) large intestine → stomach → small intestine
 (3) stomach → small intestine → large intestine
 (4) small intestine → large intestine → stomach

7. The diagram shows a bottle of paint.

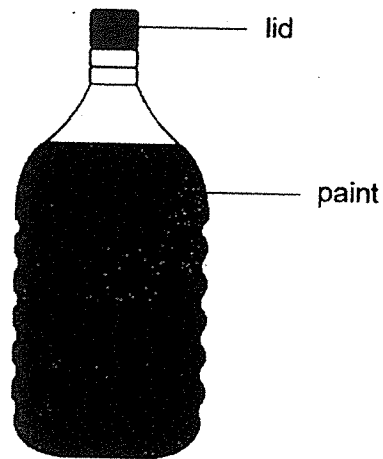

What is the state of the lid and paint?

	Lid	Paint
(1)	Gas	Liquid
(2)	Liquid	Gas
(3)	Gas	Solid
(4)	Solid	Liquid

8. The set-up shows light shining on a metal container.

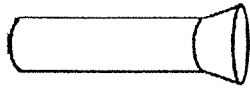

torch

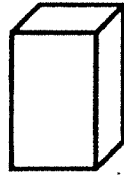

metal container

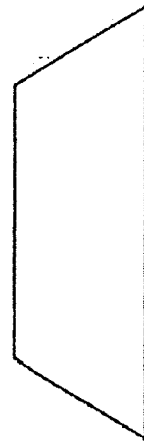

screen

Which one of the following would likely be seen on the screen?

(1)

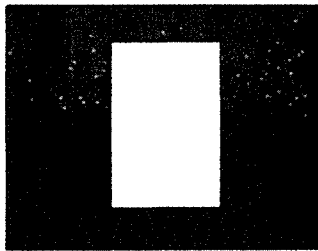

(2)

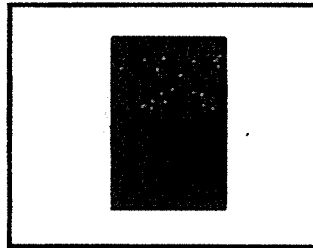

(3)

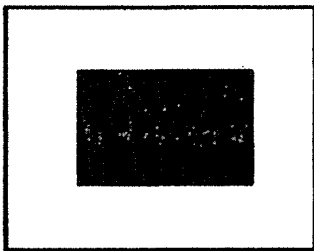

(4)



9. In which of the following set-ups will the two magnets repel each other?

(1)



(2)

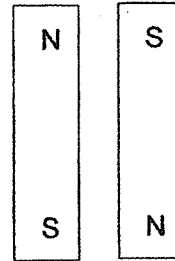

(3)

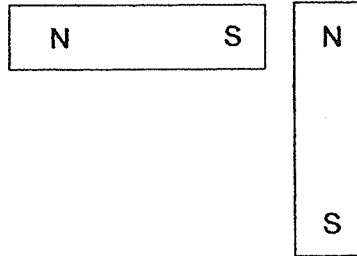

(4)

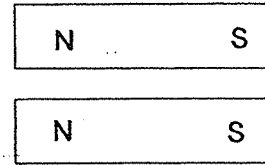

10. Hashim boiled some water in the pot shown.

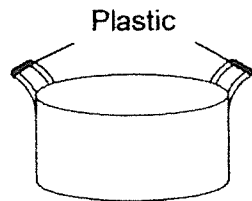

He is able to hold the pot of boiling water using the plastic handles. This is because plastic is a _____.

- (1) light material
- (2) flexible material
- (3) poor conductor of heat
- (4) good conductor of heat

11. The graph shows the amount of food eaten by the young of Animal A during the stages of its life cycle after its egg stage.

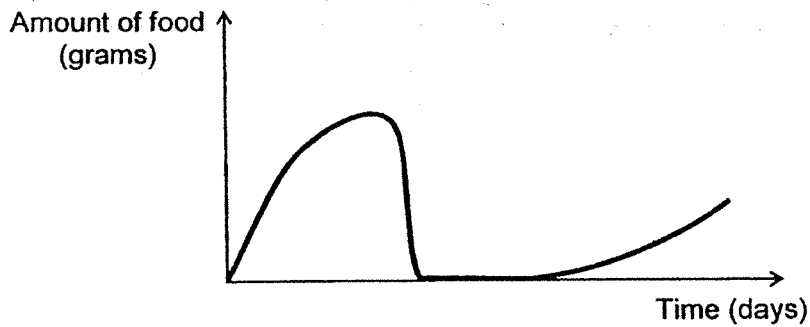

Animal A **cannot** be a _____.

- (1) butterfly
 - (2) mosquito
 - (3) grasshopper
 - (4) mealworm beetle
12. Which of the following statements is **not** true?
- (1) The nose is part of the circulatory system.
 - (2) The skeletal system gives the body its shape.
 - (3) The digestive system helps to break down food into simpler substances.
 - (4) The respiratory system takes in oxygen and removes carbon dioxide from the body.

13. Study the flowchart.

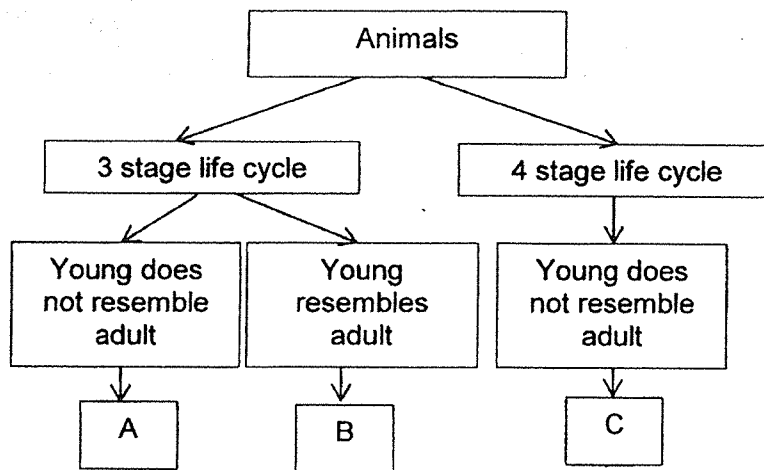

Which of the following represents animals A, B and C?

	A	B	C
(1)	grasshopper	frog	butterfly
(2)	butterfly	cockroach	frog
(3)	mosquito	grasshopper	frog
(4)	Frog	cockroach	mosquito

14. Pam observed the life cycles of two animals, A and B.

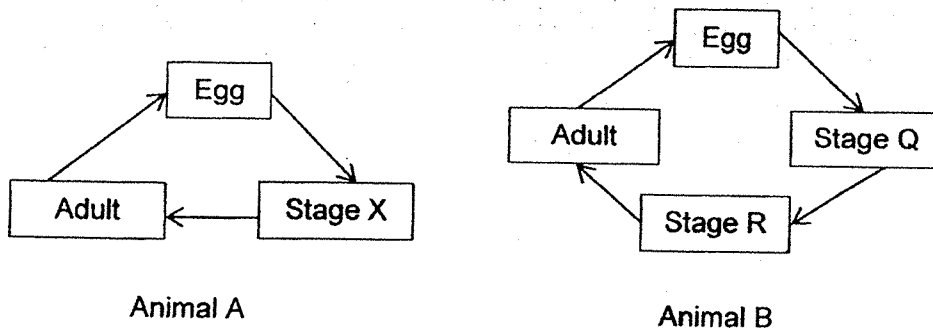

She made statements based on the information given about the two life cycles. Which of the following statements is true?

- (1) The young of both animals live in water.
 - (2) Both Animal A and Animal B have an egg stage.
 - (3) Animal A and Animal B have young that resemble their adult.
 - (4) Animal A has a four-stage life cycle while Animal B has a three-stage life cycle.
15. S, T, and U show the different stages in the growth of Plant X.

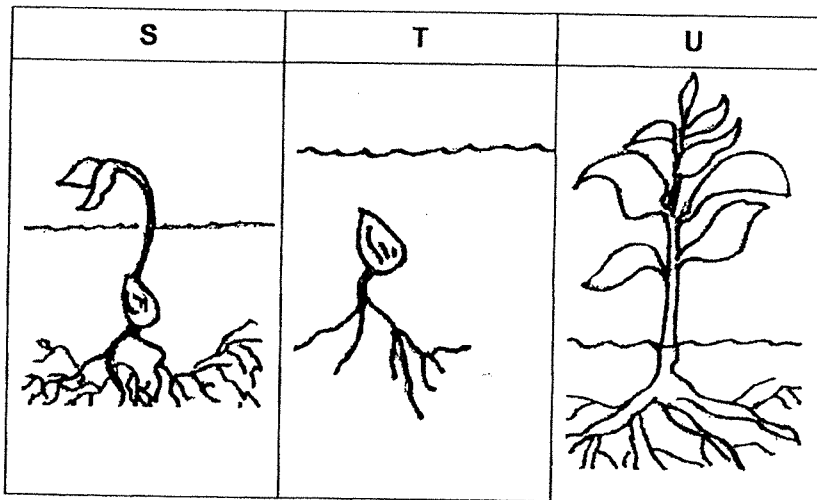

Which of the following shows the correct order of the stages of growth of Plant X?

- (1) S, T, U
- (2) T, U, S
- (3) T, S, U
- (4) U, T, S

16. The table shows the properties of substances X, Y and Z. A tick (✓) indicates that the substance has the property.

Substances	Property		
	Has a definite shape	Has a definite volume	Can be compressed
X	✓	✓	
Y		✓	
Z			✓

Which one of the following best represents substances X, Y and Z?

	X	Y	Z
(1)	Book	Air	Orange Juice
(2)	Orange Juice	Book	Air
(3)	Book	Orange Juice	Air
(4)	Air	Orange juice	Water

17. The diagrams show what happened when James placed Object A in the beaker of water and the balance.

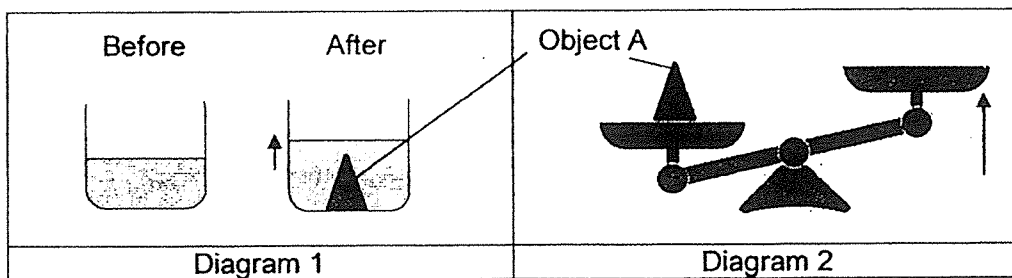

Based on his observations, he made the following conclusions:

- A: Object A has mass.
- B: Object A has volume.
- C: Object A does not have a definite volume.
- D: The mass and volume of Object A is the same.

Based on the above experiment, which of his conclusions is/are true?

- (1) A only
- (2) A and B only
- (3) B and C only
- (4) C and D only

18. Which of the following actions shows a change in state?

- (1) Building a sandcastle
- (2) Erasing part of a drawing
- (3) Tearing a piece of tissue paper
- (4) Placing a cup of water into a freezer for an hour

19. Peter had four magnets A, B, C and D as shown.

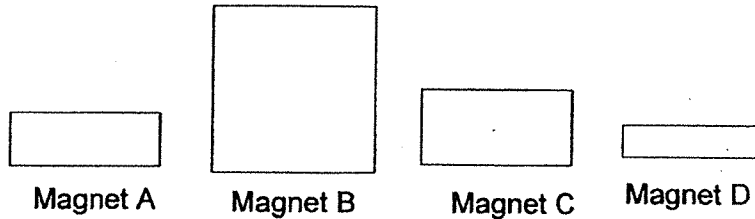

He conducted an experiment to compare the strength of the magnets. He brought each magnet near a box of paper clips and recorded the number of paper clips attracted by each magnet as shown in the table.

Magnet	Distance between the magnet and the paper clips (cm)	Number of paper clips attracted
A	5	12
B	5	8
C	5	7
D	5	14

Based on Peter's experiment, which of the following is correct?

- (1) The strength of the magnet is dependent on its shape.
- (2) The strength of the magnet is not dependent on its size.
- (3) The bigger the magnet, the weaker its magnetic strength.
- (4) The smaller the magnet, the stronger its magnetic strength.

20. Danny created a toy. During the game, the fishing rod that contains a magnetic strip interacts with the 3 different toys, fish, squid and jellyfish made of different materials.

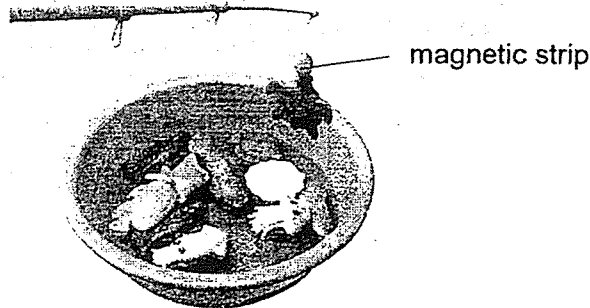

The table shows what happens to the toys when the fishing rod is brought closer to them.

Toys	Reaction to fishing rod
Fish	Attracted
Squid	Attracted
Jellyfish	No interaction

Which of the following options shows the most likely materials the toys are made of?

	Fish	Squid	Jellyfish
(1)	Glass	Iron	Aluminum
(2)	Iron	Glass	Steel
(3)	Iron	Steel	Aluminium
(4)	Aluminium	Plastic	Iron

21. Xiaoli sets up the following experiment as shown. She then placed some iron pins near these electromagnets.

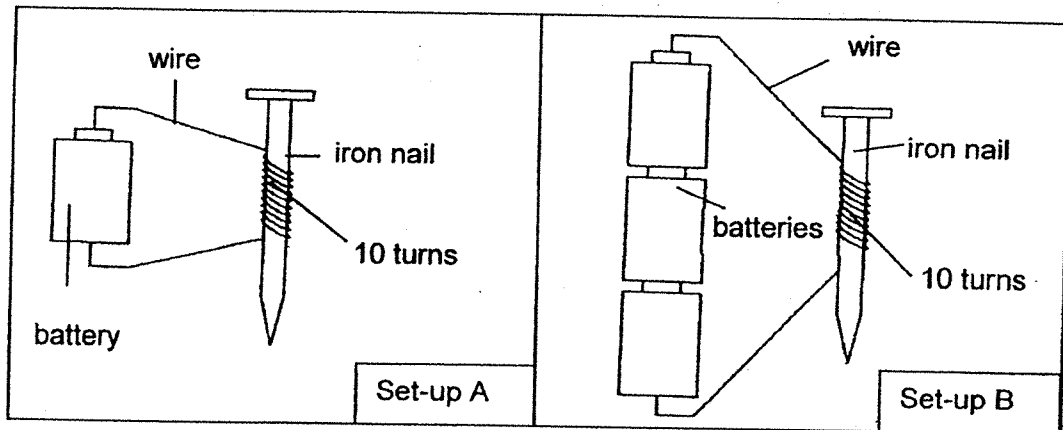

She noticed that the electromagnet in Set-up B attracted more pins than the electromagnet in set-up A. The aim of Xiaoli's experiment is to find out if the

-
- (1) size of the electromagnet affects its strength
 - (2) number of batteries used affect the strength of the electromagnet
 - (3) arrangement of the wires affect the strength of the electromagnet
 - (4) number of coils of wire around the iron nails affects the strength of the electromagnet
22. Which of the following is **not** a light source?
- (1) Fire
 - (2) Star
 - (3) Sun
 - (4) Moon

23. Danny carried out an experiment to find out how the distance between object M and the torch affects the height of the shadow formed on the wall.

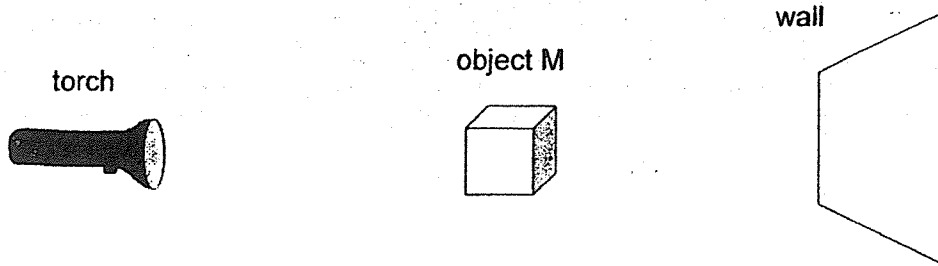

Danny recorded the results of his experiment in the table. He accidentally spilled some Milo onto his results sheet and it covered part of his result.

Distance between object M and torch (cm)	Distance between wall and torch (cm)	Height of shadow on the wall (cm)
4	15	16
7	15	13
10	15	
13	15	7

Which of the following conclusions can Danny make based on the results?

- (1) The nearer object M is to the wall, the taller the shadow.
 - (2) The nearer object M is to the torch, the taller the shadow.
 - (3) The nearer object M is to the torch, the shorter the shadow.
 - (4) The distance between object M and the torch does not affect the height of the shadow.
24. A wooden pendant was hung in a cardboard box. Sandy used black coloured plastic tubes of different shapes to look into the box. Which of the following black coloured plastic tubes will enable her to see the wooden pendant?

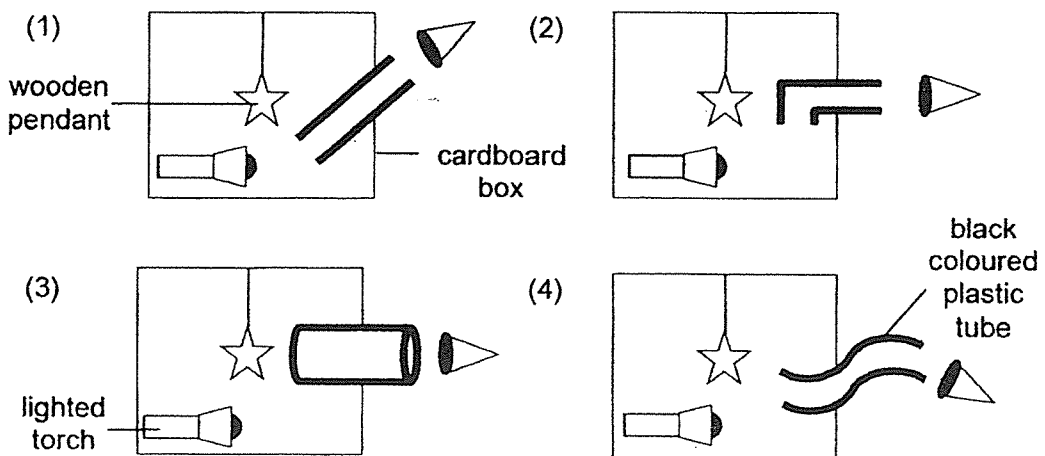

25. Joleen shines a torch on Object X as shown.

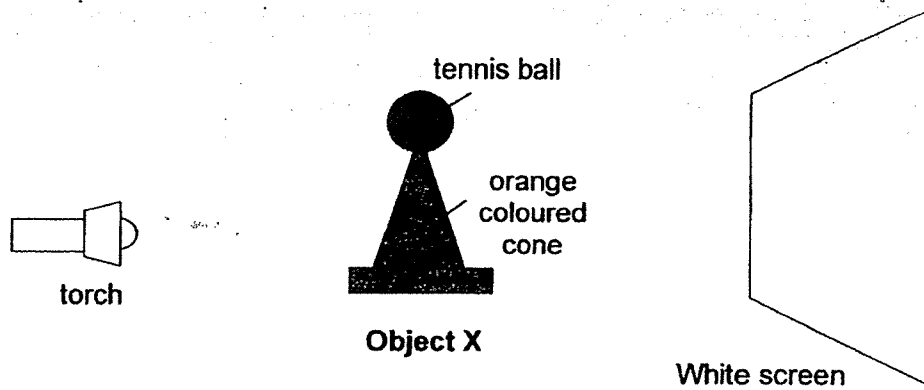

Which of the following shows the correct shadow of object X on the white screen?

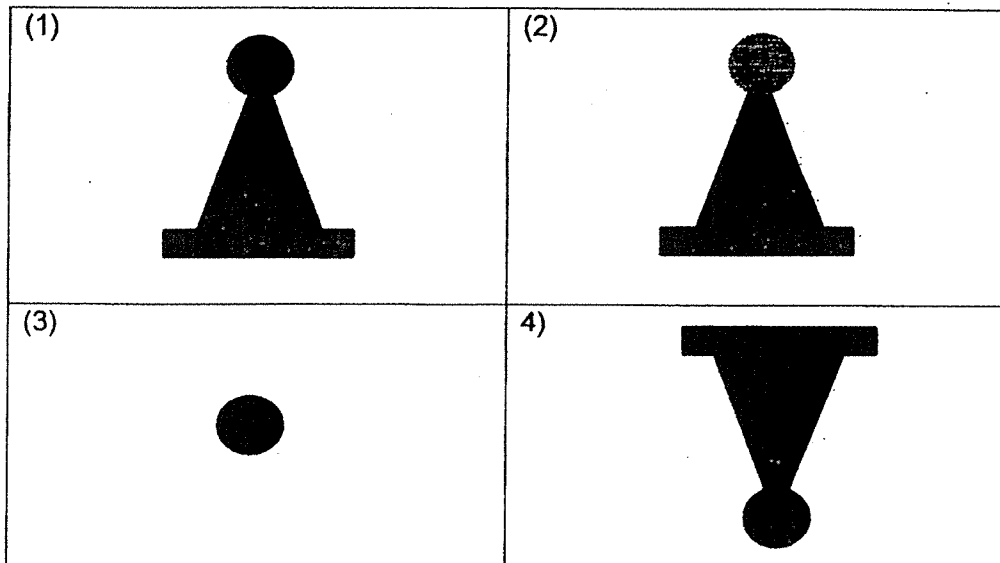

26. Which of the following statements are true about how heat travels?

- A Heat travels from solid to liquid only.
- B Heat can change the state of matter.
- C Heat travels from a hotter place to a colder place.
- D Heat travels from a colder place to a hotter place.

- (1) A and B only
- (2) B and C only
- (3) C and D only
- (4) A, B, C and D

27. Mdm Feezah conducted an experiment to find out if water can boil faster in a saucepan with a closed lid. She filled two identical saucepans with 1 litre of water and heated them using a similar flame. She observed that the water in saucepan A boiled faster than that in saucepan B.

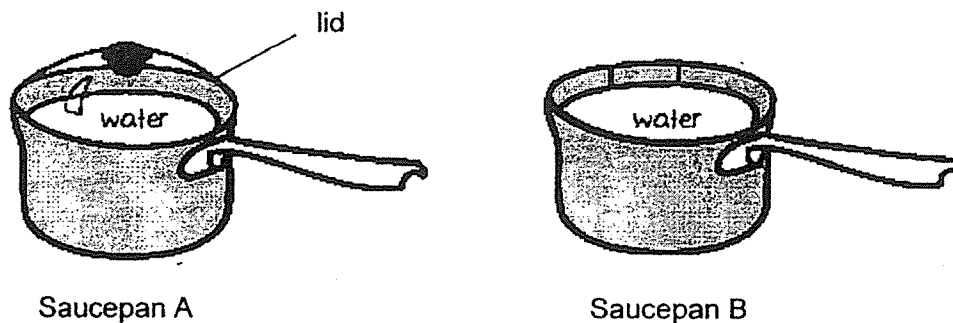

Which of the following explains her observation?

- (1) The heat from the surrounding air enters saucepan B causing the water to boil faster.
- (2) The heat in saucepan A escaped through the bottom of the saucepan, causing it to boil faster.
- (3) The heat in saucepan B traveled only to the bottom of the saucepan, causing the water to boil slower.
- (4) The heat in saucepan A was trapped inside the pot due to the lid and caused the water to boil faster.

28. Zachary set up an experiment to find out which material is most suitable to keep Milo warm for the longest period of time. He poured equal volume of Milo at 40°C into four identical sized cups made of different materials. He recorded the change in temperature of Milo for 20 minutes in the graph as shown:

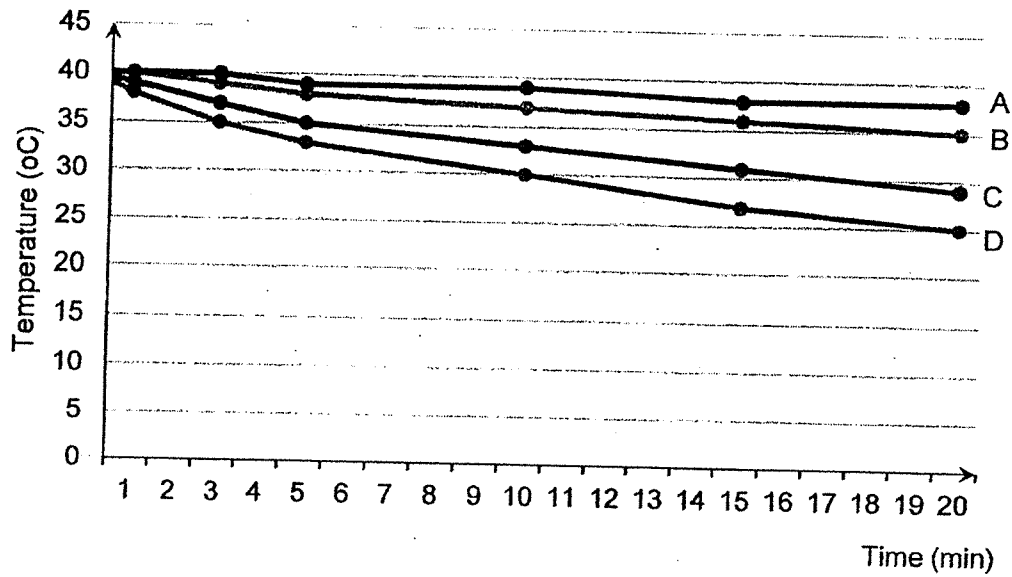

Which material A, B, C, or D is most suitable for Zachary to keep Milo warm for the longest period of time?

- (1) A
- (2) B
- (3) C
- (4) D

End of Booklet A

Anglo-Chinese School (Junior)



SEMESTRAL ASSESSMENT 2
PRIMARY 4
SCIENCE
BOOKLET B

Wednesday

1 hr 45 min

Name: _____ () Class: 4.() Parent's Signature: _____

INSTRUCTIONS TO PUPILS

- 1 Do not turn over the pages until you are told to do so.
- 2 Follow all instructions carefully.
- 3 There are 13 questions in this booklet.
- 4 Answer ALL questions.
- 5 The marks are given in the brackets [] at the end of each question or part question.

Booklet	Possible Marks	Marks Obtained
A	56	
B	44	
Total	100	

For questions 29 to 41, write your answers in this booklet.

The number of marks available is shown in brackets [] at the end of each question or part question. (44 marks)

29. The diagram shows a car.

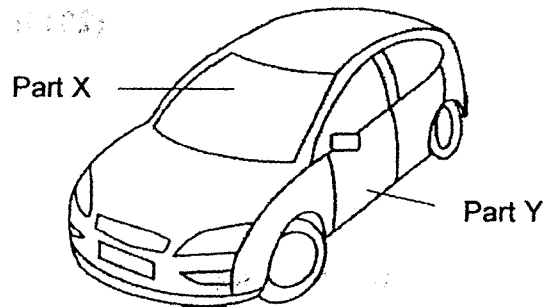

- (a) Part X is made of glass because it allows _____ to pass through so that the driver can see the road. [1]
- (b) Part Y is made of _____ because Part Y has to be strong. [1]

30. The diagram shows parts of the human digestive system.

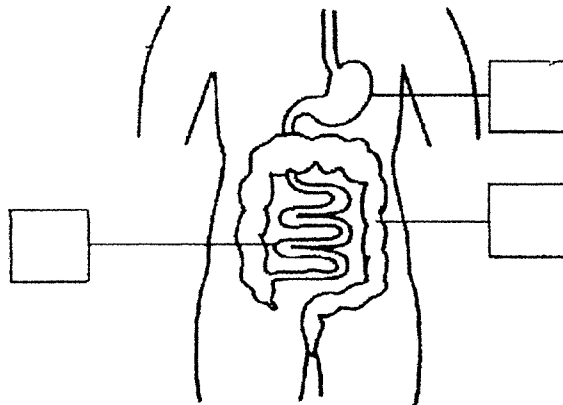

- (a) Place a tick (✓) in the box that shows where the stomach is. [1]
- (b) Place a cross (X) in the box where there is no digestion. [1]
- (c) Fill in the blank using one of the following helping words.

large intestine	small intestine	mouth
-----------------	-----------------	-------

Food from the stomach is next passed on to the _____ [1]

SCORE	5
-------	---

31. The diagram shows the growth of Plant J.

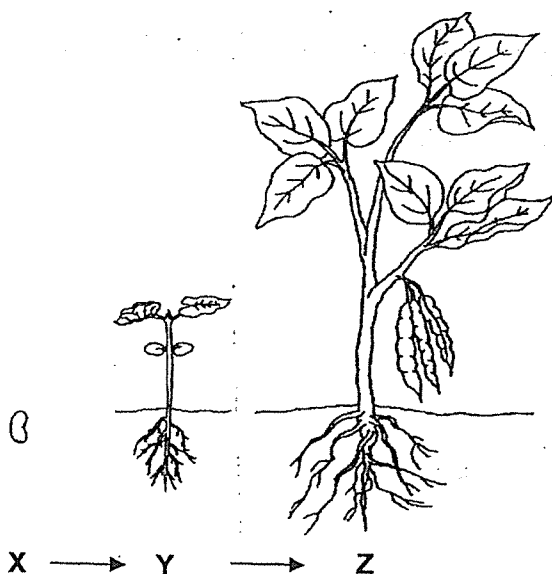

(a) Choose the correct word from the box to answer the questions. [2]

egg	seed	young plant	adult plant
-----	------	-------------	-------------

Name stages X and Z in the growth of Plant J.

X: _____

Z: _____

(b) At which stage, X or Y, can Plant J make its own food? [1]

Stage:

32. Two magnets are placed together as shown.
The north pole of Magnet 1 is labelled N.

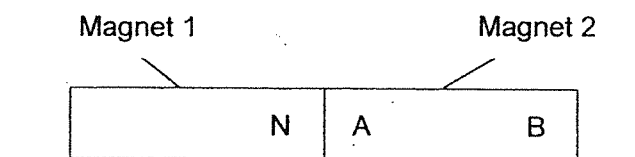

Name the poles labelled A and B on Magnet 2. [2]

A: _____

B: _____

SCORE	
	5

33. Larry set up an experiment to find out which object, A or B, has a greater volume. He filled beaker X with some water. He then lowered Object A into Beaker X and observed the water level in the beaker.

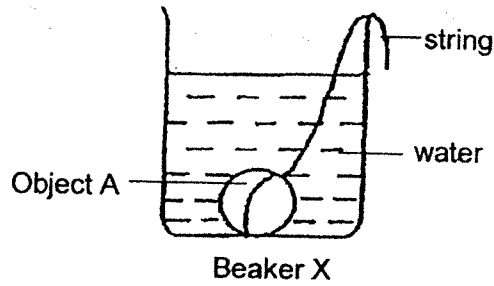

Larry repeated the experiment with the same amount of water with Object B and lowered it into Beaker Y and observed the water level in the beaker. He then concluded that Object B has a greater volume than Object A.

- (a) Using a ruler, draw the water level in Beaker Y after Object B had been lowered into it. [1]

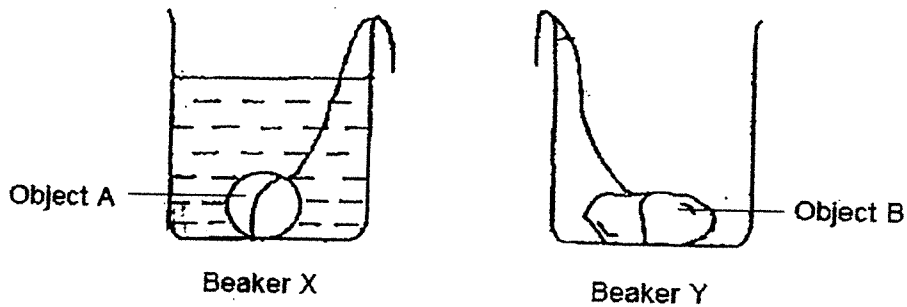

- (b) The water level in both beakers increased when the objects were lowered into them. Using the property of matter, explain clearly why the water level increased. [2]

SCORE	3
-------	---

34. The diagram shows two objects, A and B of the same volume and made of glass, placed on each side of a balance.

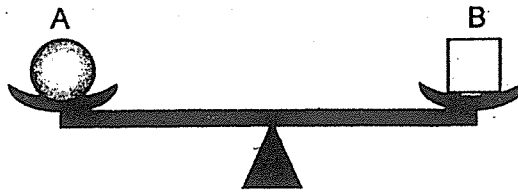

- (a) Based on your observation, state a similarity between objects A and B. [1]

Ray filled two identical containers to the brim, with objects A and B, as shown. He placed 6 pieces of object A in container M and 9 pieces of object B in container N.

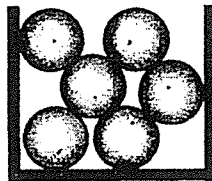

Container M

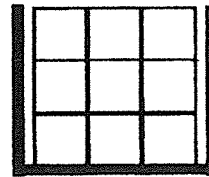

Container N

- (b) Which container, M or N, could he fill with more liquid? Explain your answer. [2]

- (c) Ray then breaks each object in container M into smaller pieces. Would the amount of liquid used to fill container M, with all the broken pieces of object A, increase, decrease or remain the same? Give a reason for your answer. [1]

SCORE	4
-------	---

35. Danny carried out an experiment where he placed seeds into four identical pots as shown in the diagram.

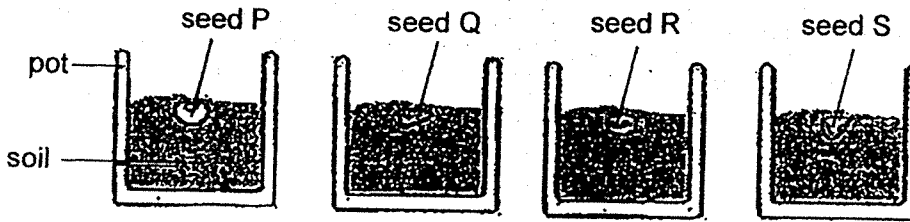

(a) State all the conditions necessary for the seeds to germinate?

[1]

Danny measured the height of the seedlings over five days and recorded his observations in the table.

Seed	Height of seedling (cm)				
	Day 1	Day 2	Day 3	Day 4	Day 5
P	0	1	3	5	7
Q	0	2	3	4	5
R	0	3	5	9	11
S	0	2	4	8	12

(b) Which seed, P, Q, R or S grew the fastest?

[1]

(c) Place a tick (✓) in the box next to the variables that should be kept the same in order for the experiment to be a fair one.

[1]

Variable	Tick (✓) the constant variables
Number of seeds	
Amount of soil	
Amount of water	
Type of seeds	
Type of soil	

(d) What was the aim of Danny's experiment?

[1]

SCORE	4
-------	---

36. Rueben conducted an experiment with two identical beakers, B and C. He wrapped beaker B with bubble wrap, a plastic sheet with air pockets. He then poured hot Milo at 80°C into each beaker.

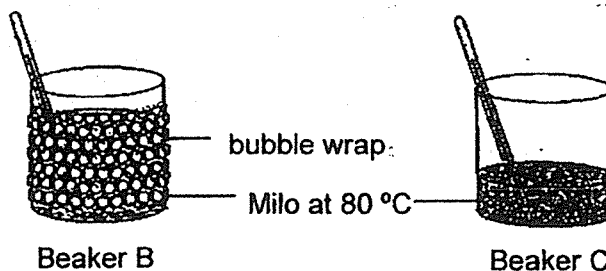

He measured the temperature of the Milo in each beaker for 20 minutes, and drew a line graph of changes in temperature.

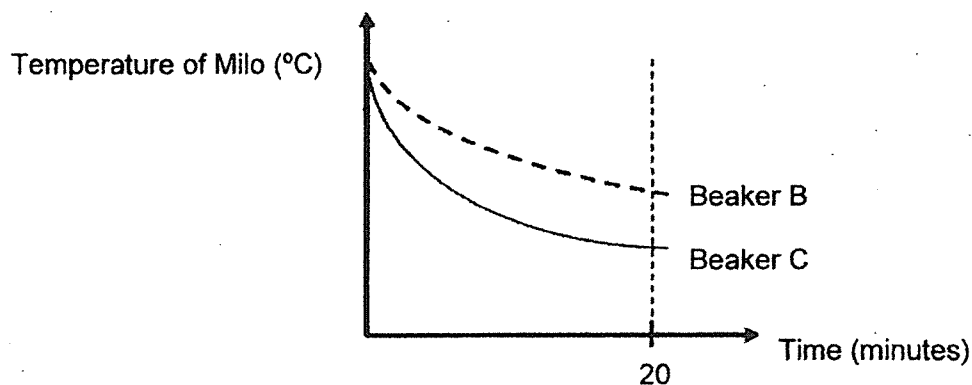

- (a) Which beaker, B or C, kept the Milo warm for a longer period of time? Explain your answer, based on the graph. [1]

- (b) State another variable that he has to keep constant to ensure a fair test. [1]

Pizzas are usually delivered in corrugated cardboard boxes which have ridges with air spaces in between them, as shown.

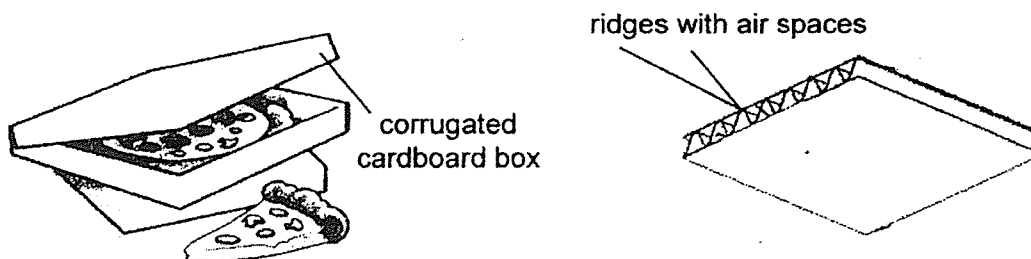

- (c) Explain why these boxes can keep pizzas warm for a longer period of time. [2]

SCORE	4
-------	---

37. Harry used the stroke method to magnetize iron nail A as shown. The tip of the nail became the north pole of the temporary magnet.

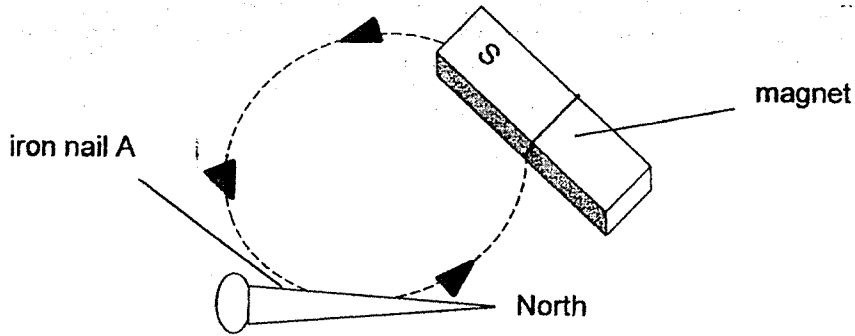

Harry then used the stroke method to magnetize iron nail B.

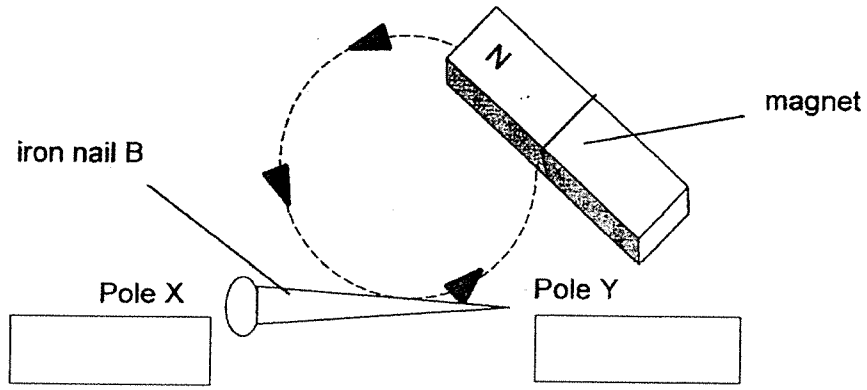

- (a) Write 'North' or 'South' in the boxes to indicate the poles at X and Y. [1]

Harry wanted to carry out an experiment. He stroked the magnet along iron nail B different number of times and placed it into a box of paper clips and recorded the number of paper clips it attracted in the table.

Number of strokes	Number of paper clips attracted
30	20
10	8
5	2

- (b) What was the aim of his experiment? [1]

- (c) State two ways the above temporary magnet can be demagnetized. [2]

SCORE	4
-------	---

38. Amanda wanted to find out how the number of coils of wire around the iron rod affects the magnetic strength of an electromagnet.

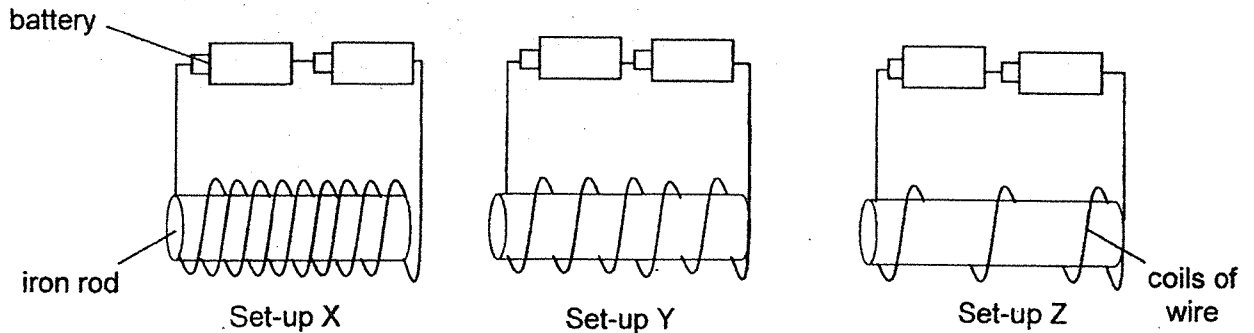

She brought electromagnet X, Y and Z near a box of paper clips and recorded the number of paper clips attracted by each electromagnet in the table.

Set-up	Number of paper clips attracted
X	10
Y	7
Z	4

- (a) What is the relationship between the number of coils of wire around the iron rod and the strength of the electromagnet? [1]

- (b) Predict the number of ^{paper clips} iron nails that will be attracted to electromagnet X when the ^{batteries are} battery is removed? Explain your answer. [1]

- (c) Give a reason why no paper clips were attracted when a gold rod was used in Set-up X. [1]

- (d) Suggest another way to decrease the strength of the electromagnet. [1]

SCORE	4
-------	---

39. (a) The diagram shows the layout of the stage for a shadow puppet show.

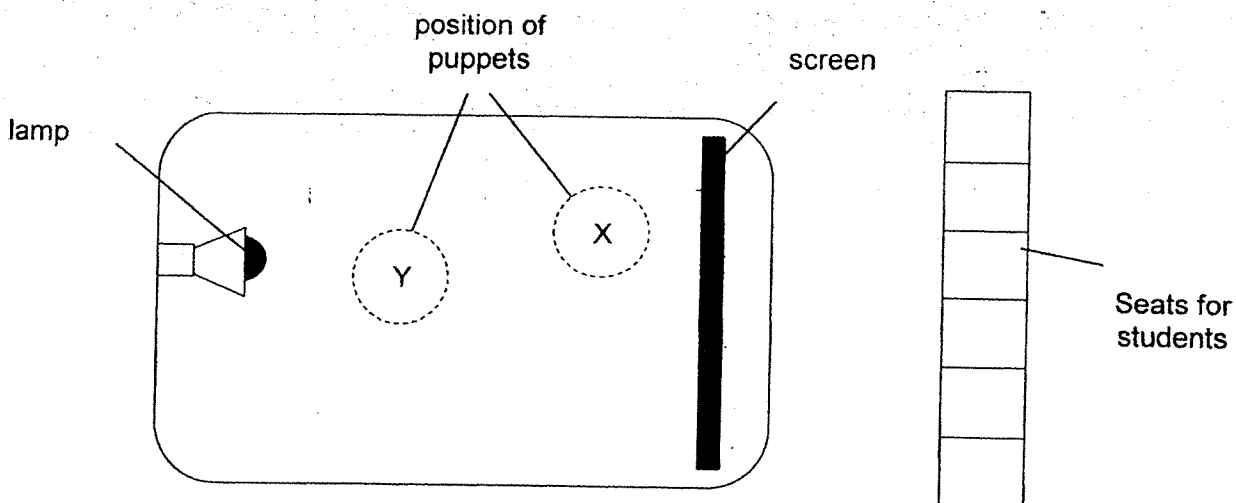

During the show two puppets of identical shape and size were used. The students at the puppet show saw the two shadows on the screen as shown.

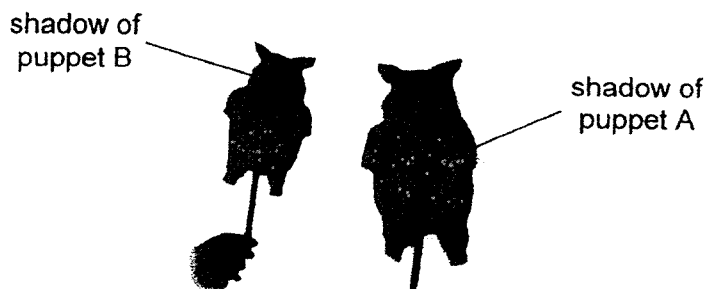

(a) In order to form the above shadows, at which positions, X and Y, were the puppets? [1]

Puppet A – _____

Puppet B – _____

(b) Give a reason for your answer in (a) [1]

(c) What is the property of the material of the screen that enables shadow to be formed on it? [1]

SCORE	3
-------	---

40. Rahul carried out an experiment in a completely dark room to find out the shadow formed by three objects, X, Y and Z as shown. Object Y has a hole in the middle.

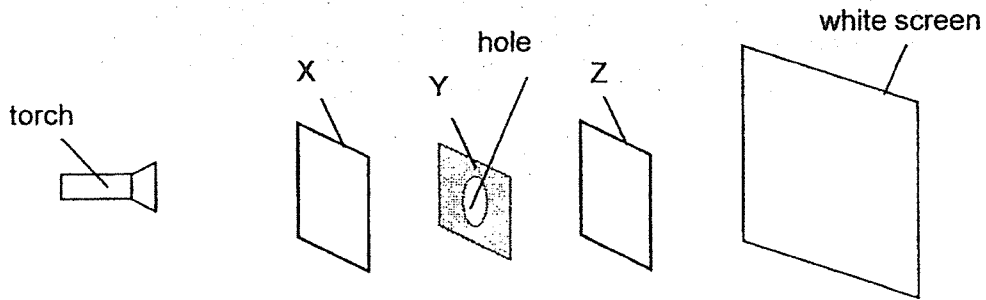

When the torch was switched on, the shadow shown below, was formed on the white screen.

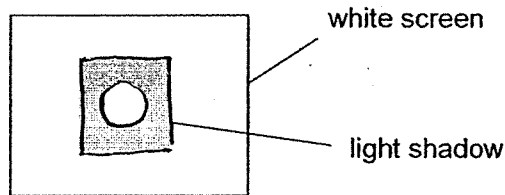

Rahul used a data-logger to measure the amount of light passing through the three different materials, X, Y and Z and recorded the results in the graph.

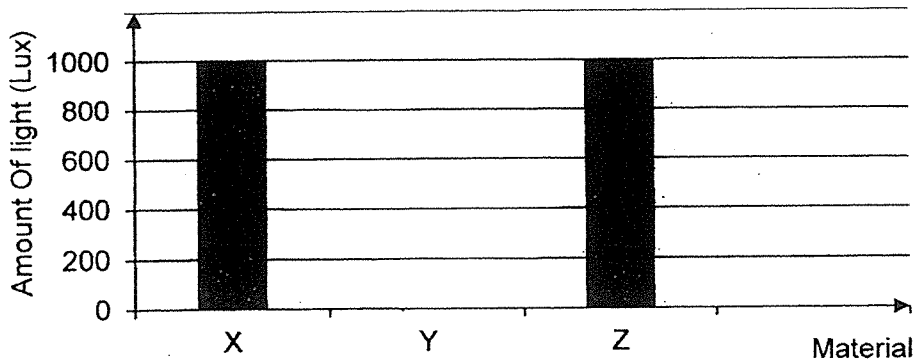

- (a) Draw the bar graph for Material Y to show the amount of light that can most likely pass through it. [1]
- (b) What is the property of Material X and Y? [1]

Material X: _____

Material Y: _____

SCORE	2
-------	---

- (c) Rahul replaced object Z with a laptop of the same size. Draw the new shadow that will form on the white screen below. [1]

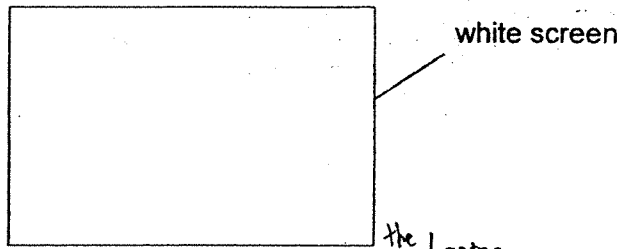

- (d) What is the property of light that allows the shadow of ~~object Z~~ ^{the Laptop} to be formed on the screen? [1]

41. Jean set-up the experiment shown with equal volume of each liquid, A, B and C, and identical stoppers.

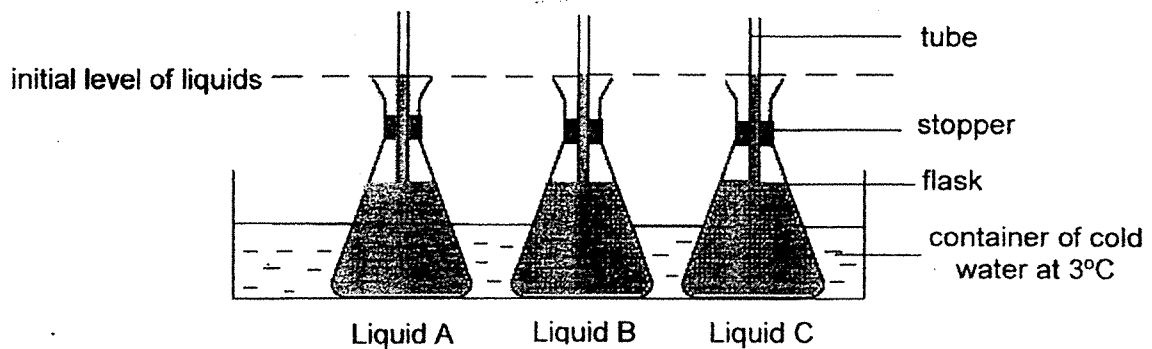

- (a) After 10 minutes, Jean noticed that the level of liquid B in the flask decreased more than liquids A and C. Explain why. [2]

- (b) Predict what will happen to the temperature of the liquids in each flask after 5 hours. Explain your answer. [2]

End of Paper

SCORE	6

ANSWER KEY



LEVEL : PRIMARY 4
SCHOOL : ANGLO-CHINESE SCHOOL (JUNIOR)
SUBJECT : SCIENCE
TERM : SA2

BOOKLET A

Q1	1	Q2	4	Q3	1	Q4	4	Q5	4
Q6	3	Q7	4	Q8	2	Q9	4	Q10	3
Q11	3	Q12	1	Q13	4	Q14	2	Q15	3
Q16	3	Q17	2	Q18	4	Q19	2	Q20	3
Q21	2	Q22	4	Q23	2	Q24	3	Q25	1
Q26	2	Q27	4	Q28	1				

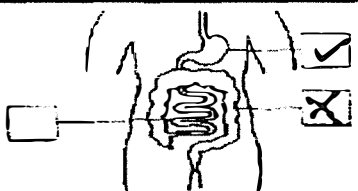
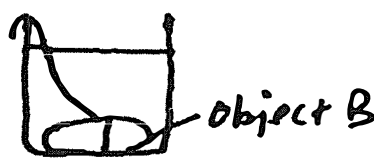
BOOKLET B

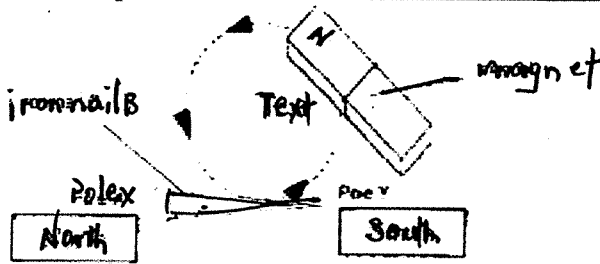
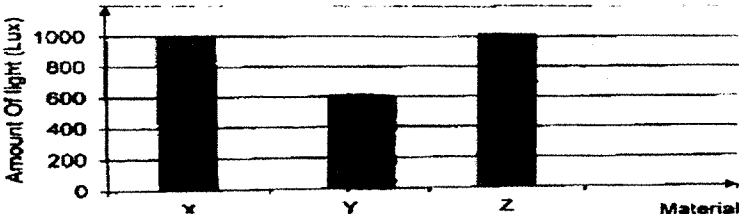
Q29	a)	light
	b)	metal
Q30	a)	
	b)	
	c)	small intestine
Q31	a)	X: Seed Z: Adult plant
	b)	Stage Y
Q32	A: South B: North	
Q33	a)	
	b)	Both objects are solid that have definite volume and occupies space, since water does not have definite shape, the water level increase.
Q34	a)	They both have the same mass
	b)	M. There are more air spaces and water can take up the space occupied by air in the container.
	c)	Remain the same, the object has a definite volume.

Q35	a)	Air, water and warmth
	b)	Seed S
	c)	<ul style="list-style-type: none"> ✓ Number of seeds ✓ Amount of soil ✓ Amount of water ✓ Type of soil
	d)	To find out which seed grows the fastest.
Q36	a)	B. The temperature of Milo in Beaker B is higher than beaker C after 20 minutes.
	b)	The amount of Milo.
	c)	Air is a poor conductor of heat so the pizzas lose heat slower to the surrounding.
Q37	a)	
	b)	To find out if the number of strokes affect the number of paper clips attracted.
	c)	Drop the magnet repeatedly or put it under flame.
Q38	a)	The more coils around the electromagnet the more the strength the electromagnet will have.
	b)	0, The iron nail will be demagnetised and loses its magnetism.
	c)	Gold is not a magnetic material.
	d)	Reduce the number of batteries used.
Q39	a)	Puppet A-Y Puppet B-X
	b)	The closer the puppet is to the lamp the bigger the shadow.
	c)	The material is a translucent object and allows light to pass through it.
Q40	a)	<p>Q40a)</p> 
	b)	Material X: Transparent Material Y: Translucent
	c)	
	d)	light travel in straight line

Q41	a)	B is the best conductor of heat. It lost heat to the cold water the fastest and contracted the most.
	b)	The temperature of the liquids will increase because they gained heat from the surrounding air until it reach room temperature.

