

SINGAPORE CHINESE GIRLS' SCHOOL (PRIMARY)

FIRST SEMESTRAL ASSESSMENT 2017

NAME: _____ ()

DATE: 2nd May 2017

CLASS: PRIMARY 6 SY

Parent's Signature:

SCIENCE
BOOKLET A

28 questions

56 marks

Total time for Booklets A & B: 1 h 45 min

DO NOT OPEN THIS BOOKLET UNTIL YOU ARE TOLD TO DO SO.

FOLLOW ALL INSTRUCTIONS CAREFULLY.

Part I (56 marks)

For each question from 1 to 28, four options are given. One of them is the correct answer. Make your choice (1, 2, 3 or 4). Shade the correct oval (1, 2, 3 or 4) on the Optical Answer Sheet.

1. Joseph placed a mouse in a glass container and covered it with a lid. The mouse died after 1 week. What could Joseph do to prevent this from happening?

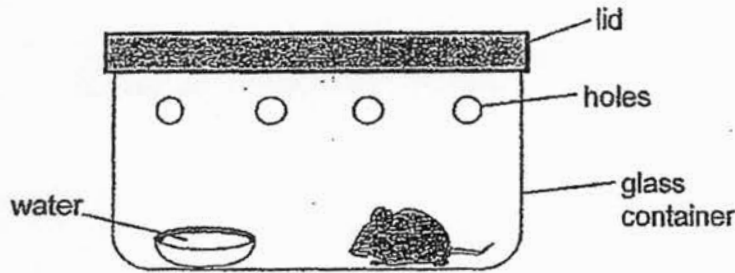

He should

- A: cover up the holes.
 B: put some food into the glass container.
 C: put another mouse in the glass container.
 D: put the glass container near a light source.

- 1) A only 3) B and D
 2) B only 4) A, C and D
2. Which of the following is **not** true about the body systems of a human?
- 1) The circulatory system transports nutrients to the other parts of the body.
 2) The respiratory system is made up of the nose, windpipe, gullet and lungs.
 3) The skeletal system and muscular system work together for the movement of the body.
 4) The digestive system breaks down food for the body to absorb.

3. Professor Lee found Animal A that could glow in the dark. He transferred the gene of Animal A that was responsible for the glow to the cell of a plant, B.

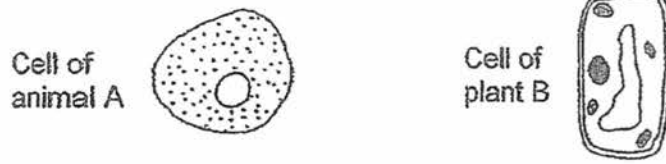

After the transfer, the cell of Plant B is able to pass down the glowing characteristic to its young. Which part of the cell did Professor Lee transfer the glow gene to?

- 1) chloroplasts
- 2) cell membrane
- 3) nucleus
- 4) cytoplasm

4. Study the flowchart below. It shows the characteristics of 3 cells, P, Q and R.

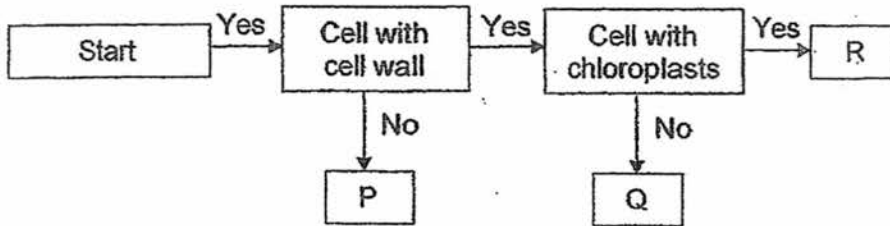

Which one of the following represents cells P, Q and R respectively?

	Human cheek cell	Bean plant leaf cell	Onion skin cell
1)	P	Q	R
2)	Q	R	P
3)	P	R	Q
4)	R	P	Q

5. Erica ran up and down the stairs for 10 minutes and made some observations about her own pulse rate. Which of the following statements is/are true?

- A: The pulse rate increases when Erica is resting.
- B: The pulse rate stops when Erica is holding her breath.
- C: The breathing rate increases when Erica's pulse rate increases.
- D: The pulse rate decreases when Erica is running up and increases when she is running down the stairs.

- 1) A only
- 2) C only

- 3) A and B only
- 4) C and D only

6. Freddie conducted an experiment with 4 set-ups as shown below.

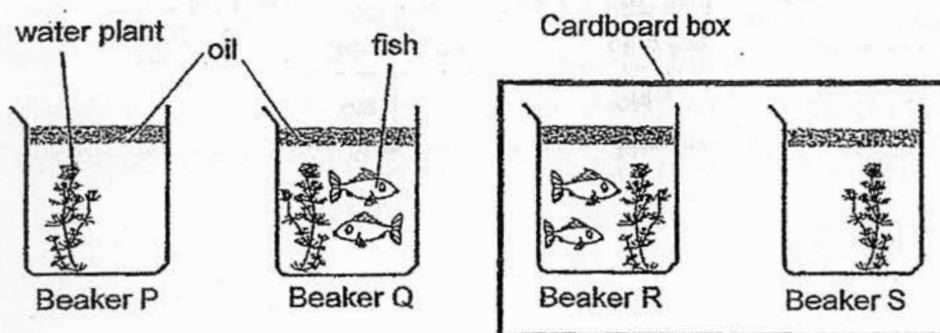

Beakers P and S contained 1 water plant each and Beakers Q and R contained 2 fishes and 1 water plant each. A layer of oil is poured into the beakers. In addition, Freddie placed Beakers R and S in a cardboard box. All the beakers were placed in a brightly lit place. Which beaker would have the least amount of oxygen at the end of an hour?

- 1) P
- 2) Q

- 3) R
- 4) S

7. The diagrams below show the flow of blood of two organisms X and Y. The arrows represent the blood vessels that carry blood from the lungs or gills to the other parts of the body.

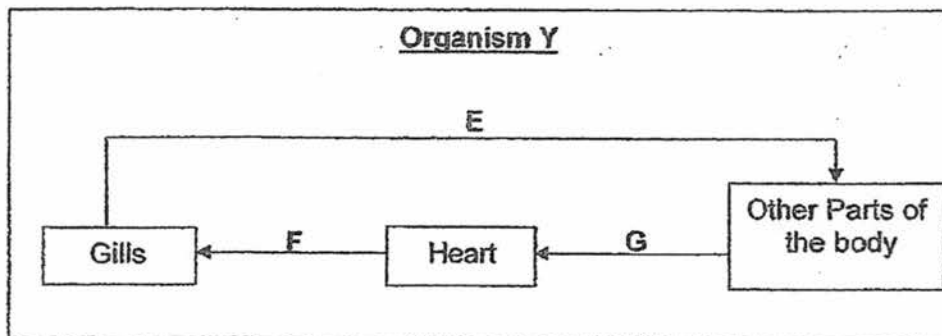
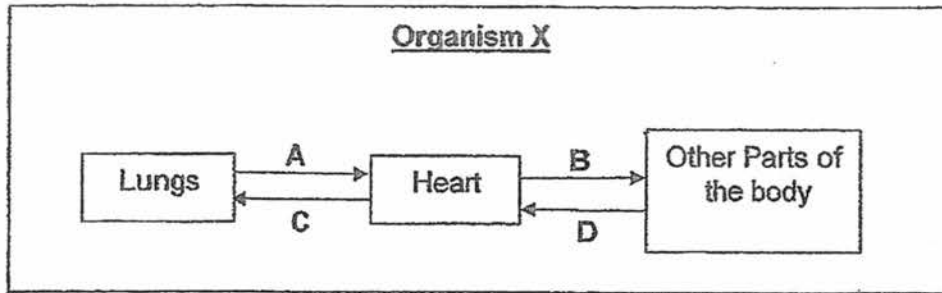

Based on the above diagrams, which of the following statements is/are correct?

Ally: Arrows A, B, E and G carry blood rich in oxygen.

Ben: Arrows C, D, G and F carry blood rich in carbon dioxide.

Carine: Arrow E carries blood rich in both oxygen and carbon dioxide.

- | | |
|---------------------|--------------------------|
| (1) Ben only | (3) Ben and Carine |
| (2) Ally and Carine | (4) Ally, Ben and Carine |

8. Norman planted two similar types of plant X and Y. Plant X was planted 3 weeks before Plant Y. Norman noticed that there were some differences between the plants and he made some inferences about them.

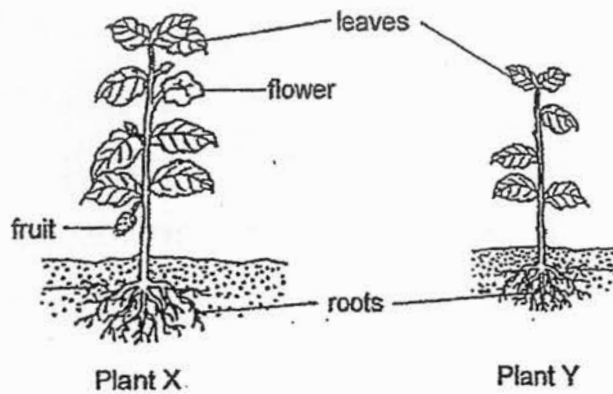

Which of the following statements is/are likely to be **true**?

- A: Both plants are adult plants.
 B: Plant Y is not able to reproduce yet.
 C: Both plants can make their own food.
 D: Plant X is likely to take in more water than Plant Y.
- 1) A and D only 3) A, B and C only
 2) B and C only 4) B, C and D only

9. Study the electrical circuit below. Which bulb, when fused, will cause all the bulbs not to light up?

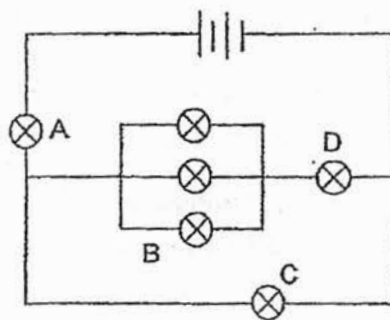

- 1) A 3) C
 2) B 4) D

10. Ling caught some fruit flies and placed them in a bottle. The fruit flies were given air, food and water. Ling recorded their population over a period of time. She then decided to add a frog into the bottle.

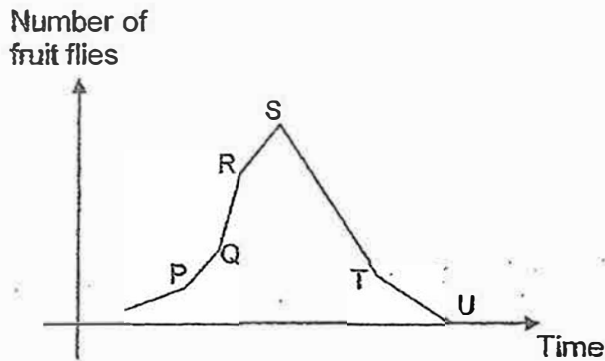

Based on the graph, at which point of time was the frog introduced?

- | | |
|------|------|
| 1) P | 3) U |
| 2) S | 4) T |

11. Study the following food chain carefully.



The food chain above shows 4 different organisms E, F, G and H found in a mini garden in a glass tank. What are the possible actions that can be done to reduce the population of organism G?

- A: Cover the tank with black cloth.
- B: Put more Organism E into the garden.
- C: Put more Organism H into the garden.
- D: Remove Organism H and put more Organism F into the garden.

- | | |
|-----------------|--------------------|
| 1) A and C only | 3) B, C and D only |
| 2) B and C only | 4) A, B and D only |

12. Lauren learnt that plants can still grow in extreme conditions. She wants to find out if the lack of water will affect the growth of plants.

Which of the following shows correctly the number of set-ups she should use, the variable that she should change and the variable that she should measure for her experiment?

	Number of Set-up/s	Variable to change	Variable to measure
1)	1	Number of plants	Number of leaves dropped
2)	1	Amount of sunlight	Number of new leaves
3)	2	Amount of water	Number of leaves dropped
4)	2	Amount of sunlight	Number of new leaves

13. Study the pie charts below.

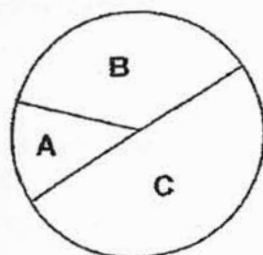

Community X

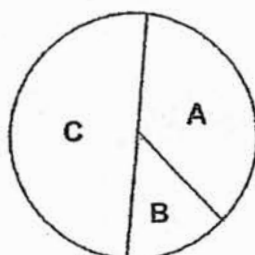

Community Y

Which of these statements about the communities is/are true?

- A: There are more C than A in Community X.
 B: There are fewer B than C in Community Y.
 C: The number of C in Community X and Community Y are equal.
 D: There are at least 3 populations of organisms in communities X and Y.

- 1) A and B only 3) A, B and C only
 2) C and D only 4) A, B and D only

14. The diagram below shows Animal A. It lives among the trees in the warm rainforest. It feeds on fruits and moves slowly.

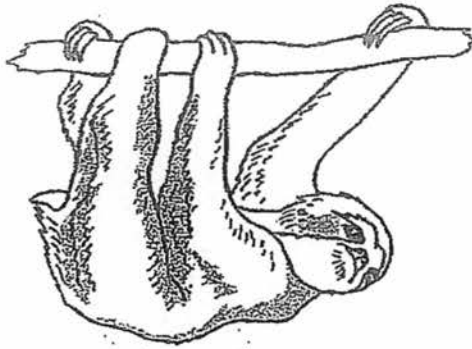

Which one of the following adaptations help Animal A when it is living in its habitat?

- | | |
|-------------------|---------------------------|
| 1) thick fur | 3) streamlined body shape |
| 2) long eyelashes | 4) strong, sturdy arms |
15. Leslie setup an experiment with a magnet, a piece of paper and an Object P. He placed Object P on a piece of paper and placed a magnet under it directly as shown in the diagram below.

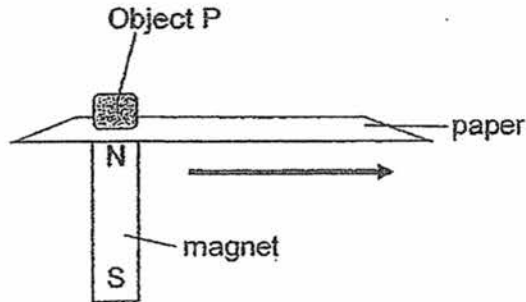

Leslie slid the magnet in the direction as shown above with both the North-seeking pole (N) and the South-seeking pole (S) and he noticed that Object P did not move. Which of the following could be a possible reason for it?

- 1) The paper is too thin.
- 2) The magnet is too small.
- 3) The magnet is too strong.
- 4) Object P is made of a non-magnetic material.

16. Study the chart below.

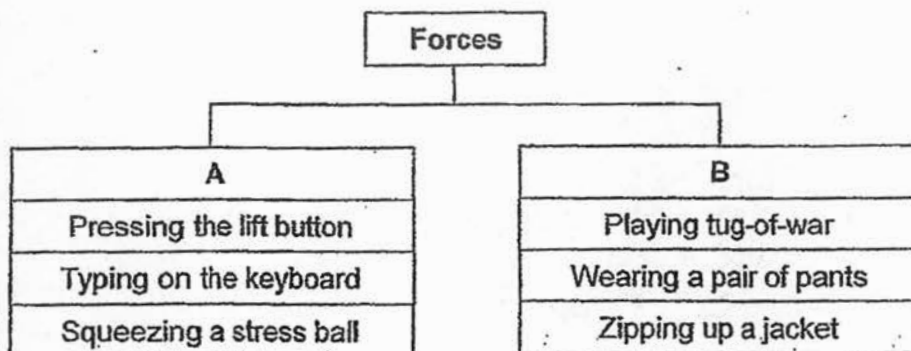

Which of the following is the most appropriate heading for A and B?

	A	B
1)	Push force	Pull force
2)	Changes shape	Does not change shape
3)	Has frictional force	Has no frictional force
4)	Changes the direction	Does not change the direction

17. Gary wanted to find out how the lengths of different springs, A, B, C and D, change when a weight of 50 grams is added to each spring.

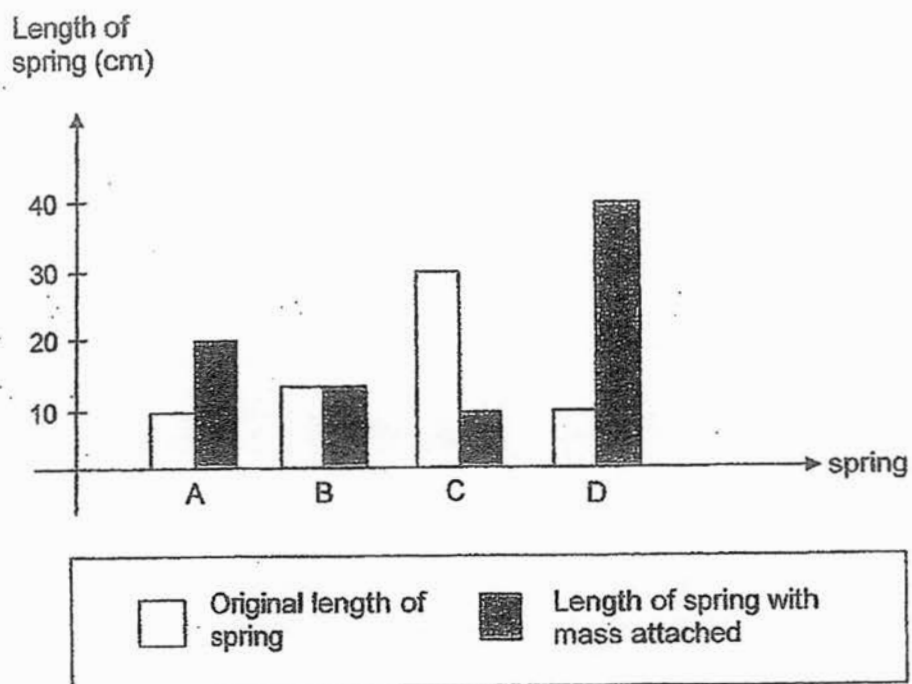

He conducted the experiment and plotted a graph as shown above. Based on the graph, which of the following statement/s is/are true about the springs?

- A: Spring A extended to twice its length.
 B: Spring C is a spring that was compressed.
 C: Spring D is extended more than Spring A.
 D: Spring B needs a weight greater than 50g to cause a change in its length.

- 1) A and B only
 2) B and C only
 3) A, C and D only
 4) A, B, C and D

18. The diagrams below show the life cycles of 2 different insects.

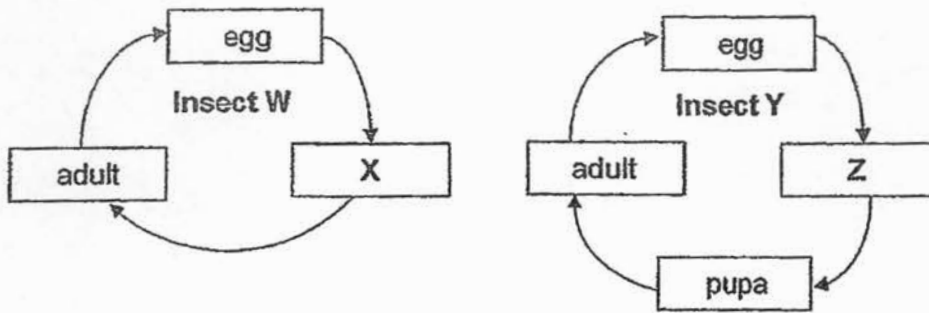

Which of the following correctly matches W, X, Y and Z in the 2 life cycles?

	Insect W	Stage X	Insect Y	Stage Z
1)	moth	larva	cockroach	nymph
2)	moth	nymph	cockroach	larva
3)	cockroach	nymph	butterfly	larva
4)	cockroach	larva	butterfly	nymph

19. The diagram below shows the cross-section of a flower.

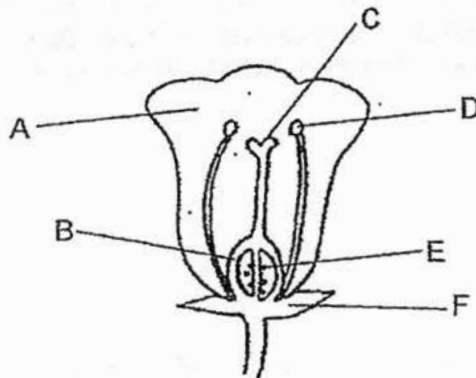

Given that pollination has not taken place, which one of the observations is **correct** when the various parts of the flower are removed?

	Parts removed	Observation
1)	A and D	The flower will be able to bear fruits.
2)	A and C	The flower will be able to bear fruits.
3)	B and F	The flower will be able to bear fruits.
4)	C and E	The flower will be able to bear fruits without seeds.

20. 4 friends, Kit, Lucy, Min and Kumar, discussed what will happen to the female reproductive system if a cut was made at point S.

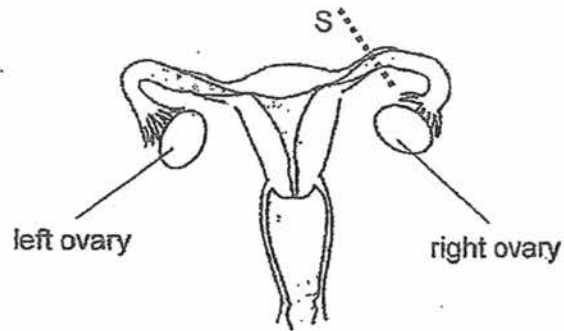

These are the statements they made:

- Kit: The female will not be able to get pregnant.
 Lucy: The left ovary will stop producing eggs.
 Min: The sperm will be able to travel to the egg produced by the left ovary.
 Kumar: The foetus will not be able to develop in the womb.

Who was correct?

- | | |
|---------|----------|
| 1) Kit | 3) Min |
| 2) Lucy | 4) Kumar |

21. Seng Choon poured 100cm^3 of coarse salt into a container. He then added 100cm^3 of fine salt into the container. After she has poured in the fine salt, she gave the container a shake and placed it on the table.

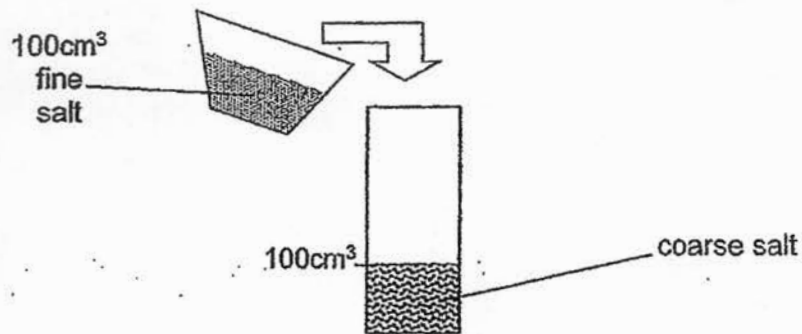

Which container shows the most possible new level of the salt?

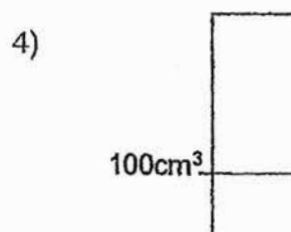
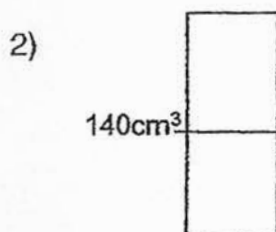
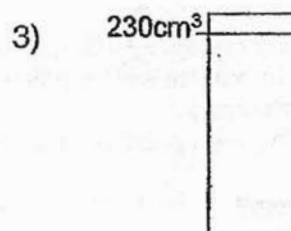
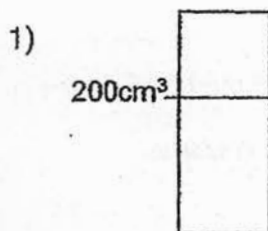

22. Study the following diagram.

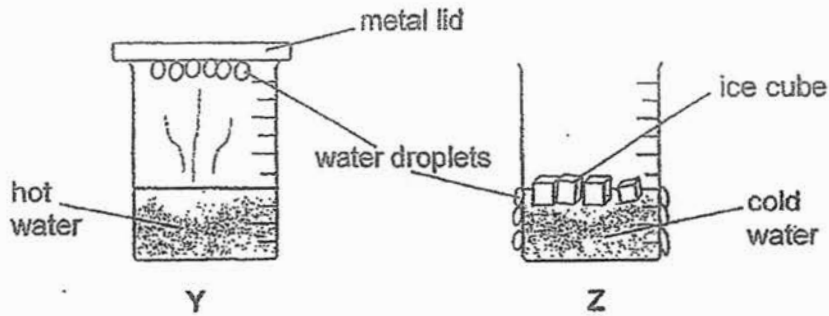

Where did the water droplets on each surface condense from?

	Setup Y	Setup Z
1)	hot metal lid	ice cubes in cold water
2)	warm water vapour from surrounding air	warm water vapour from surrounding air
3)	hot water vapour from hot water	cold surface of beaker
4)	hot water vapour from hot water	warm water vapour from surrounding air

23. Joseph left 3 blocks of ice of different sizes on the table at the same time.

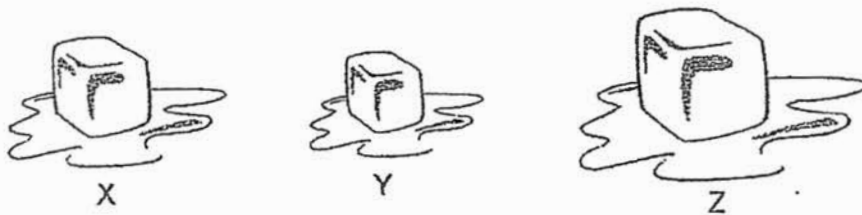

Which of the following statements about the ice cubes is correct?

- 1) Y has the lowest temperature.
- 2) X will take the longest time to melt.
- 3) Z will need more heat to melt it than X.
- 4) All the ice cubes have a temperature of more than 0°C .

24. Study the diagram of the water cycle carefully.

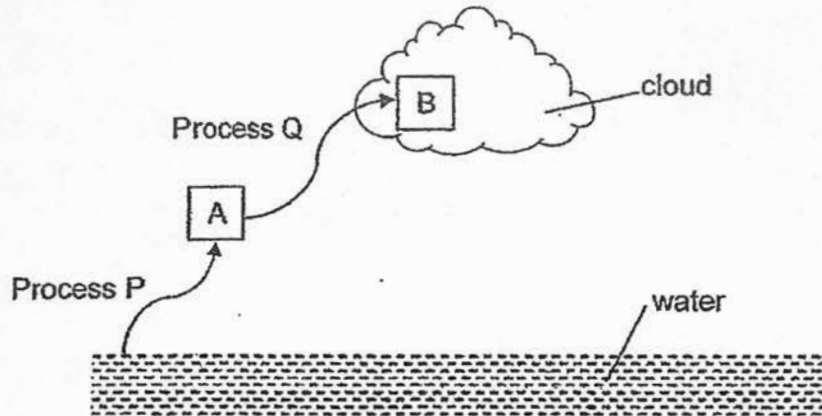

Which of the following shows the correct state of water and processes in the water cycle respectively?

	A	B	P	Q
1)	Liquid	Gas	Evaporation	Condensation
2)	Gas	Liquid	Evaporation	Condensation
3)	Gas	Liquid	Condensation	Evaporation
4)	Liquid	Gas	Condensation	Evaporation

25. Linda took a leaf and placed it in the dark for 2 days.

After 2 days, she did the following to the leaf:

- sealed one end of it, Part P, with a plastic bag
- placed some substance to remove the carbon dioxide in the plastic bag
- covered Part Q with a piece of black paper
- left Part R untouched

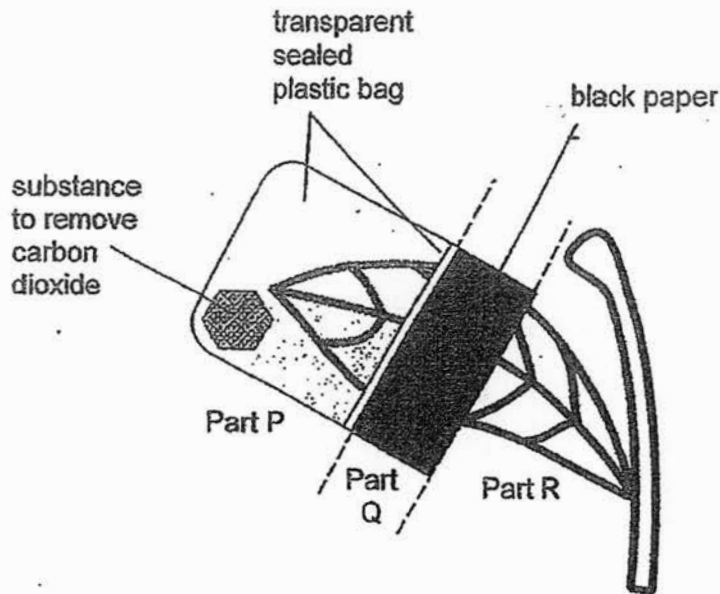

Linda then placed the leaf under sunlight and tested for starch with iodine solution 5 hours later. What could be the possible results that she will be able to see? Note: Iodine turns dark blue when it reacts with starch.

	P	Q	R
1)	iodine turned dark blue	iodine turned dark blue	iodine remained yellow
2)	iodine remained yellow	iodine turned dark blue	iodine remained yellow
3)	iodine remained yellow	iodine remained yellow	iodine turned dark blue
4)	iodine turned dark blue	iodine remained yellow	iodine turned dark blue

26. Leo uses a light sensor to count the number of customers entering his shop. When a customer walks into the shop, light will be blocked from the light sensor. The graph below shows the data collected by the light sensor in 30 seconds.

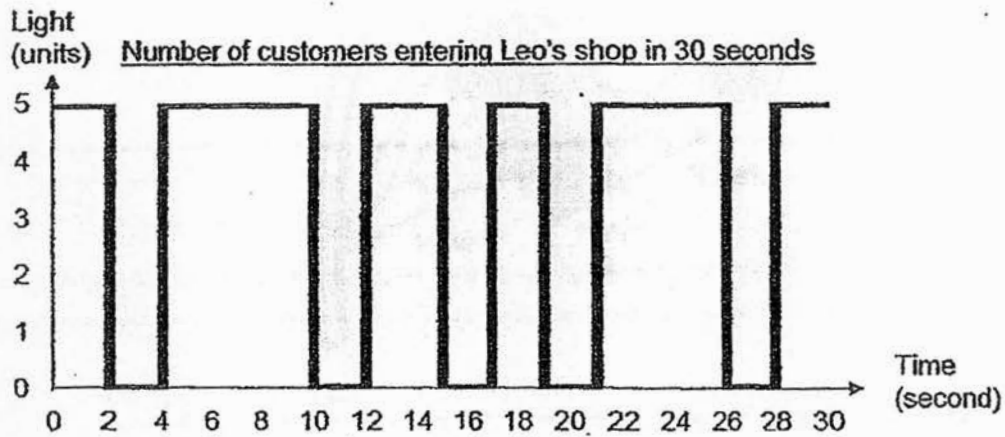
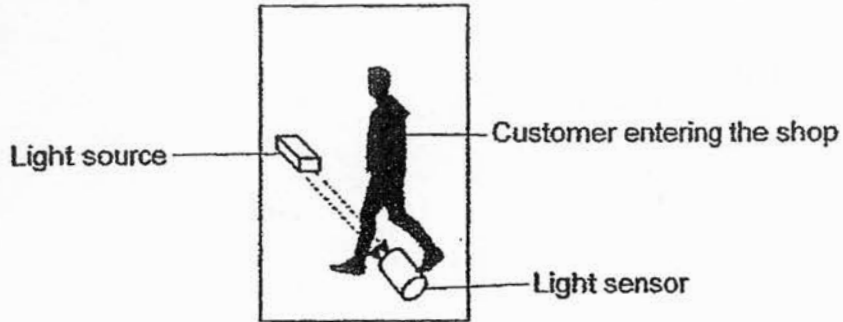

How many customers entered Leo's shop in 30 seconds?

- (1) 5
 (2) 6
 (3) 28
 (4) 30

27. Hui Leng wanted to find out if the position of an object would affect the length of its shadow on the screen. The experiment was set up as shown in the diagram below.

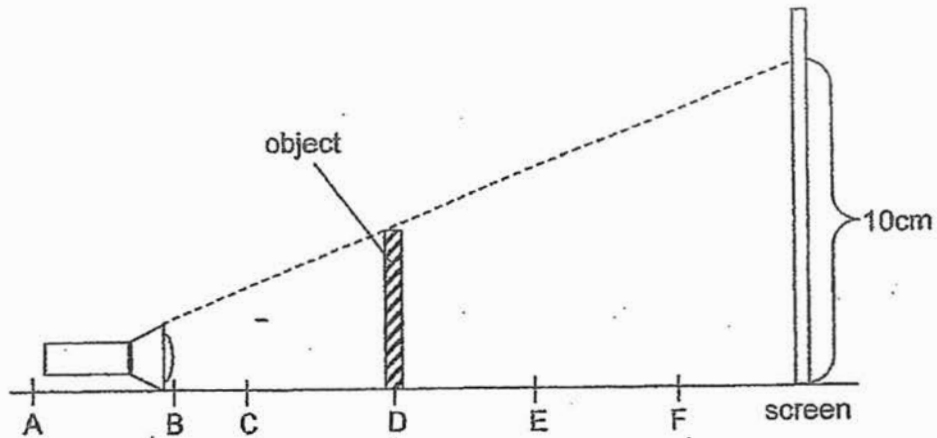

Hui Leng noticed that when she placed the torch at Position B, the object makes a shadow of 10cm. She then placed the torch at different positions and recorded her findings in the table below.

Which set of recorded data is correct?

	Position of torch	Position of Object	Length of shadow
1)	A	D	11cm
2)	B	F	6cm
3)	C	D	8cm
4)	B	C	9cm

28. A toy car is travelling from A to B.

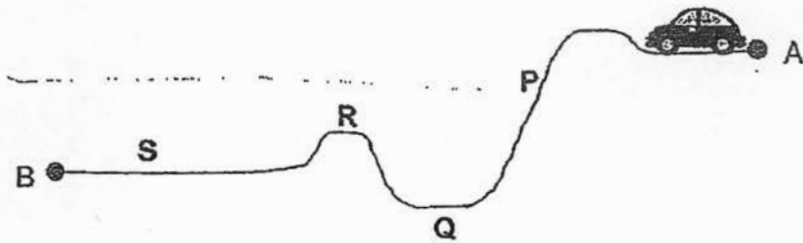

At which point P, Q, R or S will the toy car have the greatest gravitational potential energy?

- 1) P
- 2) Q

- 3) R
- 4) S

End of Paper

SINGAPORE CHINESE GIRLS' SCHOOL (PRIMARY)

FIRST SEMESTRAL ASSESSMENT 2017

NAME: _____ ()

DATE: 2nd May 2017

CLASS: PRIMARY 6 SY

Parent's Signature:
_____SCIENCE
BOOKLET B

	Total Actual Marks	Total Possible Marks
Booklet A		56
Booklet B		44
Total		100

13 questions

44 marks

Total time for Booklets A & B: 1 h 45 min

DO NOT OPEN THIS BOOKLET UNTIL YOU ARE TOLD TO DO SO.

FOLLOW ALL INSTRUCTIONS CAREFULLY.

Name: .

Date: .

Class: Primary 6 SY.

Part II (4 marks)

Answer all the following questions.

29. Study the following classification of insects.

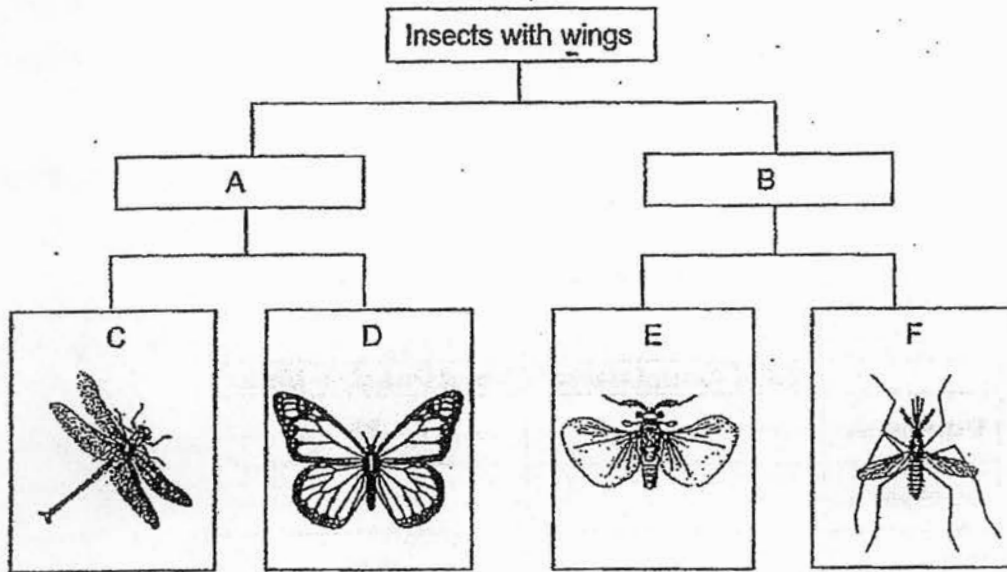

a) What is the most suitable heading for A and B? (2m)

A	
B	

b) Can the spider be classified under the above classification table? Why or why not? (1m)

c) The 4 insects C, D, E and F above can be further classified by the shape of their wings. Classify them by writing the letters in the boxes provided. (1m)

Broad Wings	Long, Narrow Wings



30. Gopal observed some fishes in his tank. He wanted to confirm whether the fishes are living or non-living things and decided to conduct 2 experiments to find out.

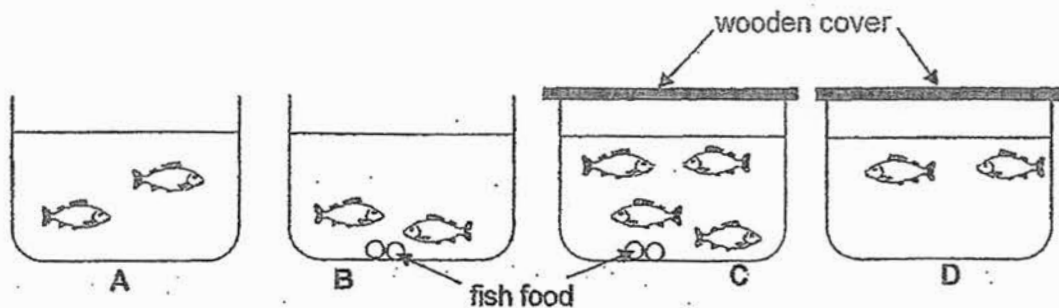

- a) If the aim for the 1st experiment is to find out if living things need air to survive, which 2 setups should he use? (1m)

Setup and

- b) If the aim for the 2nd experiment is to find out if living things need food to survive, which 2 setups should he use? (1m)

Setup and

- c) Gopal improved his experiment by putting 3 more fishes into each tank. How did this improve the experiment? (1m)

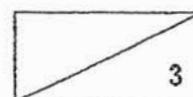

31. Wen Jie carried out an experiment with 2 similar plants. He cut off the roots of Plant P and removed some leaves from Plant Q. Wen Jie planted both plants in the soil and watered them every day.



- a) Plant P died after a few days. Explain why this had happened. (1m)

- b) Wen Jie conducted a similar experiment with Plant Q and another similar plant, Plant R.

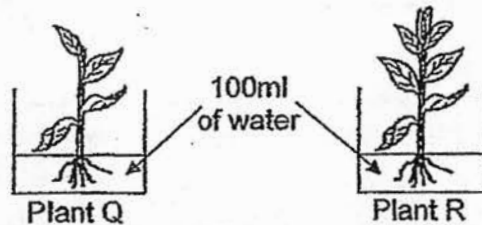

He took out Plant Q from the soil and placed both plants Q and R in 2 beakers containing 100ml of water respectively and recorded the amount of water left in the beakers after 2 days.

What is the aim of his experiment? (1m)

- c) Design the **control setup** to show that any water lost from the plant is caused only by the plant and draw the setup/s in the box provided below (1m) and label the diagram (1m).

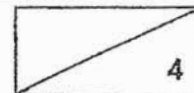

32. Hugo set up a circuit as shown in the diagram below.

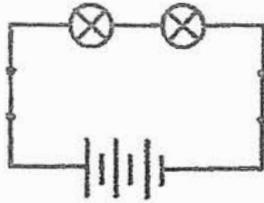

- a) If Hugo adds 1 bulb in series to the circuit, how would it affect the brightness of the existing bulbs? (1m)

- b) If Hugo wanted to change the setup so that each of the 2 bulbs can be switched on and off independently and are of the same brightness, how should he change the setup? Draw the new circuit diagram below in the box provided. Use only the same items provided in the above setup. (2m)

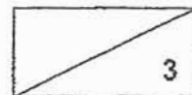

33. The graph below shows the population size of a predator and its prey living in a certain habitat over a few years.

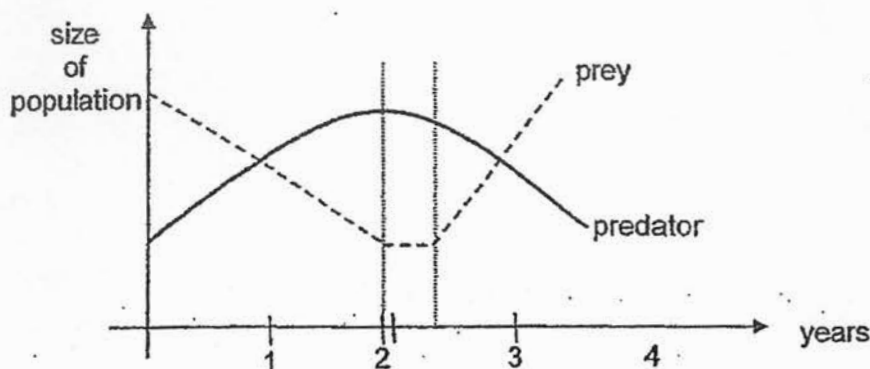

Write 'T' (true), 'F' (false) or 'NPTT' (not possible to tell) in the boxes provided below. (3m)

	Statements	T, F or NPTT
a)	Hunters killed all the predators in 1 year.	
b)	The prey is the only food source for the predator.	
c)	The population of the prey and predator were the same twice.	
d)	When the population of predators decreased, the population of prey increased immediately.	
e)	The population of the prey will continue to increase if the population of the predator continues to decrease.	
f)	The number of predators is higher than the number of prey from Year 1 to Year 2.	

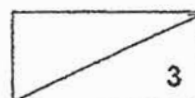

34. The following picture shows a cactus plant growing in the desert.



a) Explain how the two structural adaptations listed below benefit the cactus. (2m)

Structural Adaptation	Benefit of adaptation
needle-like leaves	
juicy stem	

b) The porcupine has a coat of sharp spines like the cactus with spiny leaves.



The spines of the porcupine serve the same purpose as the spiny leaves of the cactus. How does it help both the organisms? (1m)

c) The camel can also be found in the desert. How does having extra-long eyelashes help the camel survive the sandy condition of the desert? (1m)

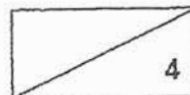

35. Rani attached a wooden block weighing 200g to a spring and pulled the block across 3 different materials - unpolished wood, sandpaper and polished marble from Point X to Y as shown below.

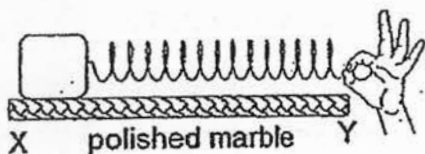
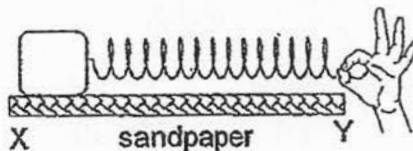
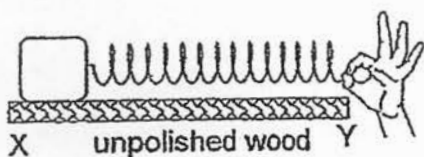

- a) Which surface needed the least amount of force to pull across? Why? (2m)

- b) Rani then used a 500g block and repeated the experiment. Put a tick \checkmark in the appropriate boxes to indicate which forces have increased, decreased or not applicable at all. (2m)

Type of force	Increase	Decrease	Not applicable
Gravitational force			
Frictional force			
Magnetic force			
Elastic Spring force			

- c) Explain why using a spring balance will make the results in (a) more reliable? (1m)



36. Kit Leng dropped Ball P from a release height of 100cm into a container filled with soft sand and the ball caused an indentation in the sand as shown below.

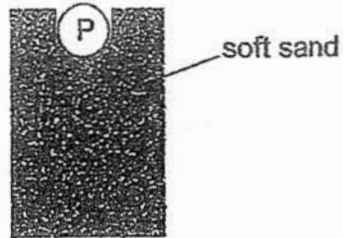

She repeated the experiment with 3 other balls, Q, R and S and recorded the data in the table as shown.

Ball	Indentation caused by the ball (cm)
P	3
Q	6
R	1
S	4

- a) What was the main force was acting on the balls when they were dropped? (1m)

- b) What could cause Ball Q to have the deepest dent in the soft sand? (1m)

- c) What could be done to the release heights if Kit Leng wanted Ball Q and Ball R to cause the same depth of indentation? (1m)

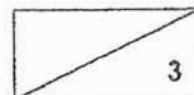

37. Judy found Fruit A as shown below in her garden. She observed that it has hard tiny hooks and concluded that it cannot be dispersed by animals because the animals will not be able to eat and digest the fruit.

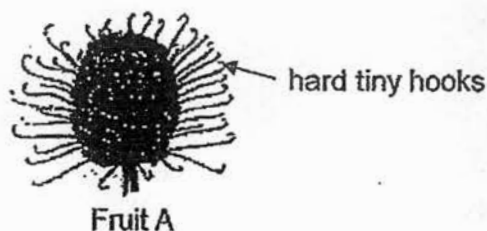

- a) Is her conclusion correct? Explain your answer. (1m)

Judy found another fruit as shown below and it looks similar to the Fruit A. However, it has soft hair and juicy sweet flesh surrounding its seeds.

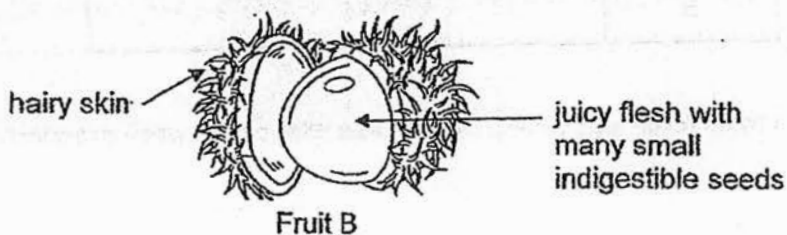

- b) Describe how animals are likely to disperse the seeds above. (1m)

- c) Between Fruit A and Fruit B, which fruit benefits from being lighter in mass? Why? (1m)

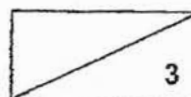

38. Harry filled 4 containers A, B, C and D with the same amount of water at room temperature and left them in different places with 4 different conditions for 3 hours.

Container	A	B	C	D
Conditions	Windy Cloudy	No wind Cloudy	Windy Sunny	No wind Sunny

- a) In the bar graph below, add 2 bars that best represents the water left in the containers B and C after 3 hours. (2m)

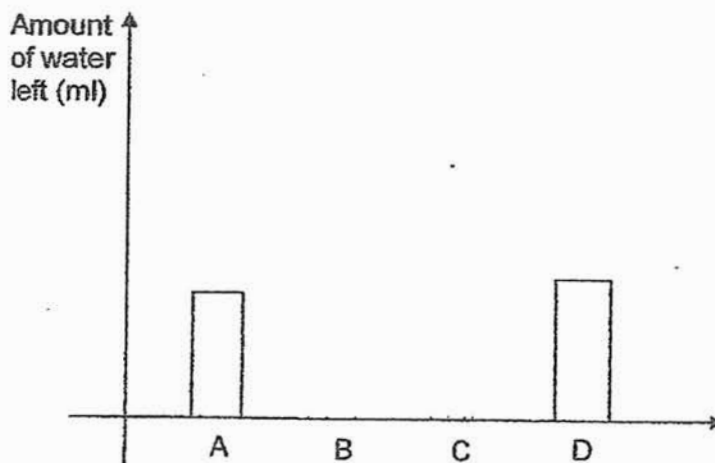

- b) If Harry used hot water instead of water at room temperature for this experiment, how will the rate of evaporation be affected? (1m)



39. Kate conducted an experiment. She lit a candle and allowed the same amount of wax from the candle to drip onto 4 different materials.

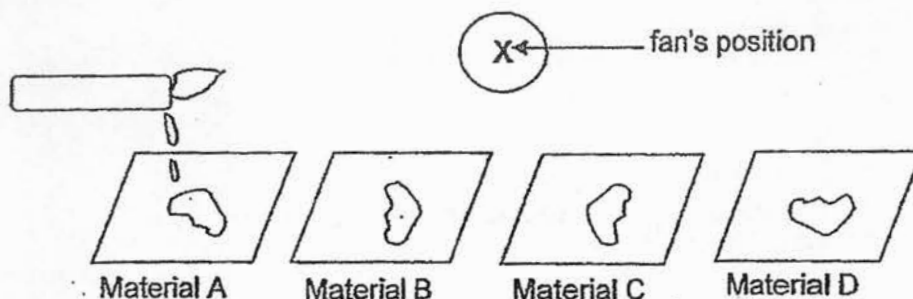

Kate then recorded the time taken for the wax on the material to solidify in the table below.

Material	A	B	C	D
Time taken for the wax to solidify (seconds)	8	13	6	4

- a) Based on the table above, which material is the best conductor of heat? (1m)

- b) Which material is the most suitable to make a container for keeping Kate's cold juice cool for the longest time? (1m)

- c) Kate's classmate commented that Kate can speed up the experiment by placing a fan at position labelled X as shown in the diagram. Will this make it a fair test? Explain your answer. (2m)

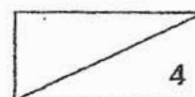

40. Joan conducted some experiments with the set-up shown below to find out about shadows and the properties of light.

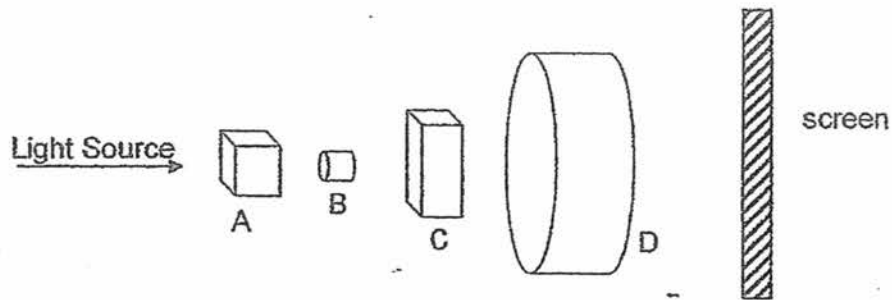

When she placed objects A, B, C and D in the above line-up, the shadow formed on the screen was as follows:

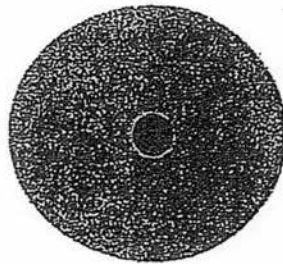

Shadow formed on the screen

- a) Suggest the degree of transparency for each material that made up the objects. (2m)

A: _____

C: _____

B: _____

D: _____

- b) If Joan swapped the positions of A and C, will the shadow formed on the screen change? (1m)

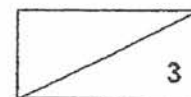

41. A man standing on Platform A jumps onto a see-saw at Point B. A box placed at Point C moves in the path as shown below and lands at Point E.

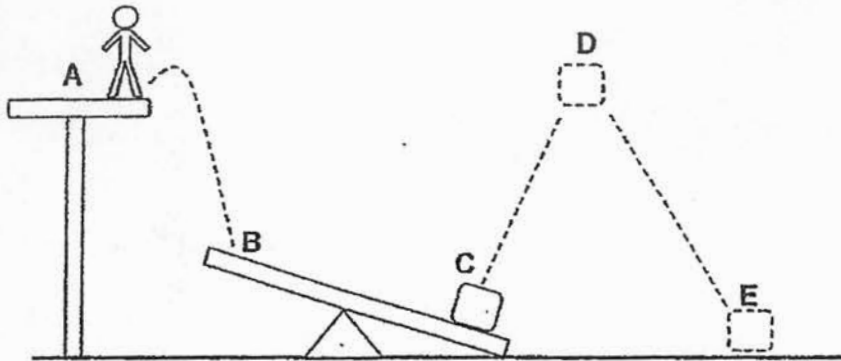

- a) What is the energy conversion from the point when the man jumps off to the point when the box lands? (2m)

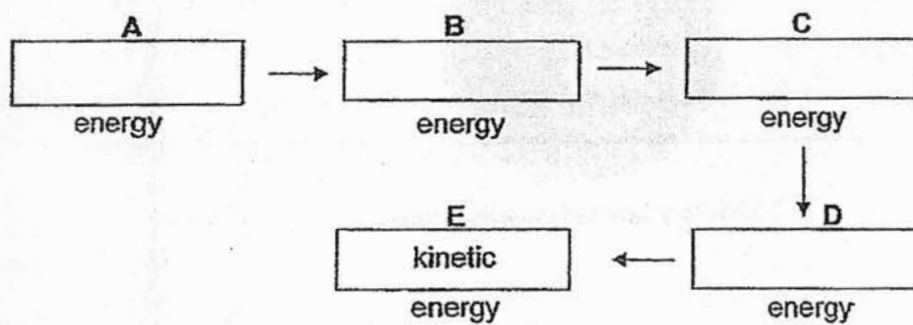

End of Booklet B

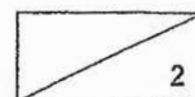

YEAR : 2017
 LEVEL : PRIMARY 6
 SCHOOL : SINGAPORE CHINESE GIRLS' PRIMARY SCHOOL
 SUBJECT : SCIENCE
 TREM : SEMESTRAL ASSEMENT (1)

SECTION A

Q1	Q2	Q3	Q4	Q5	Q6	Q7	Q8	Q9	Q10
2	2	3	3	2	3	1	4	1	2
Q11	Q12	Q13	Q14	Q15	Q16	Q17	Q18	Q19	Q20
1	3	4	4	4	1	4	3	1	3
Q21	Q22	Q23	Q24	Q25	Q26	Q27	Q28		
2	4	3	2	3	1	2	1		

SECTION B

Q29. a)

A	4 wings
B	2 wings

b) The spider does not have wings.

c)

Broad Wings	Long, Narrow Wings
D and E	C and F

Q30. a) Ans: A and D

b) Ans: B and A

c) He wanted to increase the reliability of the experiment by increasing the sample size.

Q31. a) Plant P could not take in the water and minerals from the soil.

b) He wanted to find out if the number of leaves in the plant will affect the amount of water absorbed by the plant.

c)

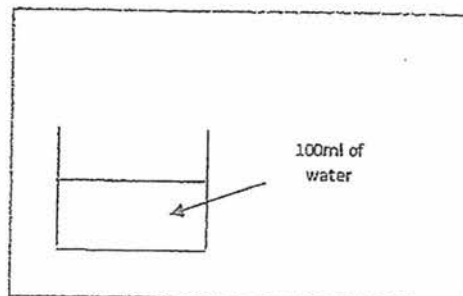

- Q32. a) The existing bulbs will become dimmer.
b)

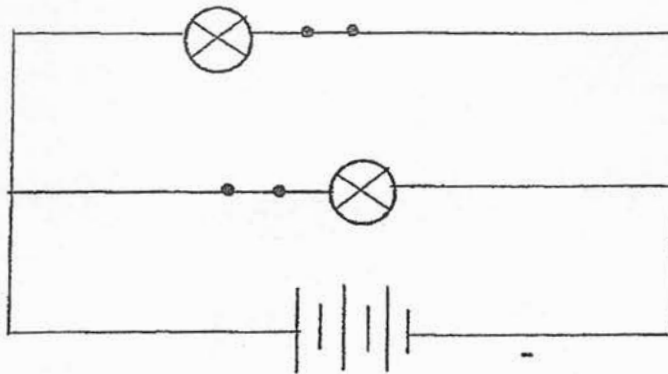

- Q33. a) F
b) NPTT
c) T
d) F
e) T
f) T

- Q34. a)

Structural Adaptation	Benefit of adaptation
needle-like leaves	to protect itself from animals
Juicy stem	to store water so it will not die

- b) The spines of both protects them from being eaten.
c) The eyelashes helps to protect itself from getting sand in its eyes.
- Q35. a) The polished marble. The polished marble reduce friction between the wooden block and the surface.
- b) i) Gravitational force - increase
ii) Frictional force - increase
iii) Magnetic force - not applicable
v) Elastic Spring force - increase
- c) We can use the spring balance to allow us to measure the amount of force accurately.

SCGS SA1

- Q36. a) Gravitational force.
 b) Ball Q was the heaviest
 c) Ball R could be dropped at a greater height while Ball Q could be dropped at a lower height.

- Q37. a) No. The fruit has hooks which can hook onto animal's fur, allowing the fruit to be dispersed.
 b) The animals will eat the juicy flesh together with the small seeds. The seeds are passed out in their dropping after digestion. By then, the seeds would have been carried far away from its parent plants.
 c) Fruit A. The hooks of fruit A can cling onto the fur of the animals and can be easily carried away by the animals because of its light mass.

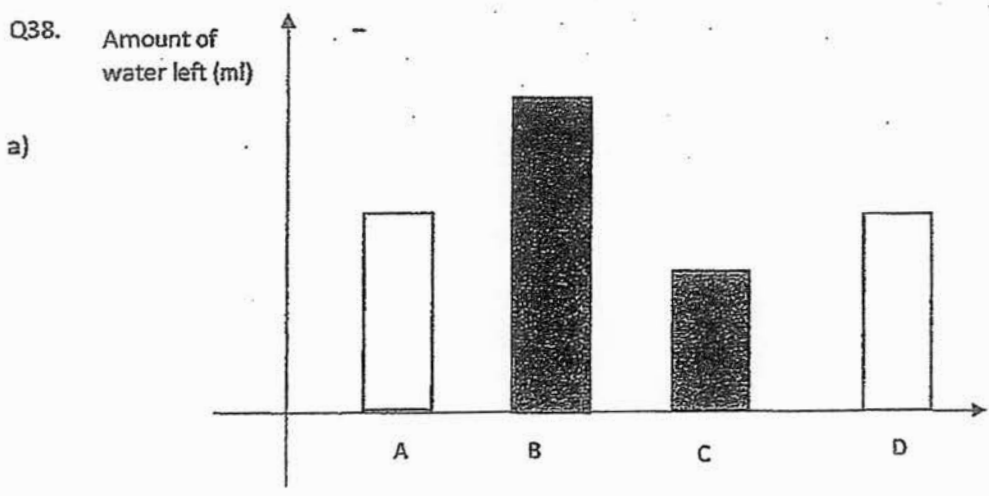

- b) The rate of evaporation will be faster.

- Q39. a) Material D.
 b) Material B.
 c) No, it will not. The fan's wind will be stronger between Materials B and C than A and C, causing the wax to dry up faster between the Materials B and C.

- Q40. a) A: transparent C: transparent
 B: Opaque D: translucent
 b) No.

- Q41. a) A - gravitational potential energy
 B - kinetic energy
 C - kinetic energy
 D - gravitational potential energy

